



- EN** Forceps
- DE** Pinzetten
- ES** Pinzas

Page 95 to 111





Standard



Standard

06-1901-10	10.5cm
06-1901-11	11.5cm
06-1901-13	13.0cm
06-1901-14	14.5cm
06-1901-16	16.0cm
06-1901-18	18.0cm
06-1901-20	20.0cm
06-1901-23	23.0cm
06-1901-25	25.0cm
06-1901-30	30.0cm



Narrow

06-1902-10	10.5cm
06-1902-11	11.5cm
06-1902-13	13.0cm
06-1902-14	14.5cm
06-1902-16	16.0cm
06-1902-18	18.0cm
06-1902-20	20.0cm
06-1902-23	23.0cm
06-1902-25	25.0cm
06-1902-30	30.0cm



USA Model



06-1903-12	12.0cm
06-1903-13	13.0cm
06-1903-14	14.5cm
06-1903-15	15.0cm
06-1903-18	18.0cm
06-1903-21	21.0cm
06-1903-25	25.0cm
06-1903-31	31.0cm



06-1904-12	12.0cm
06-1904-13	13.0cm
06-1904-14	14.5cm
06-1904-15	15.0cm
06-1904-18	18.0cm
06-1904-21	21.0cm
06-1904-25	25.0cm



Stille
06-1905-15
15.0cm

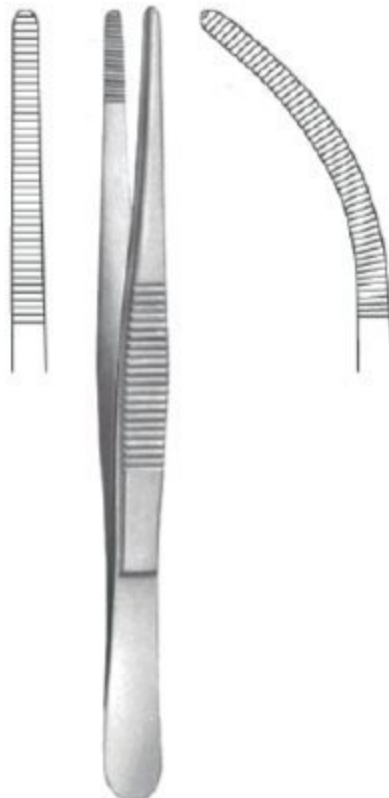

Ochsner
06-1906-14
14.0cm



Treves
Turn over
06-1907-12 12.0cm
06-1907-15 15.0cm
06-1907-18 18.0cm
06-1907-20 20.0cm
06-1907-25 25.0cm

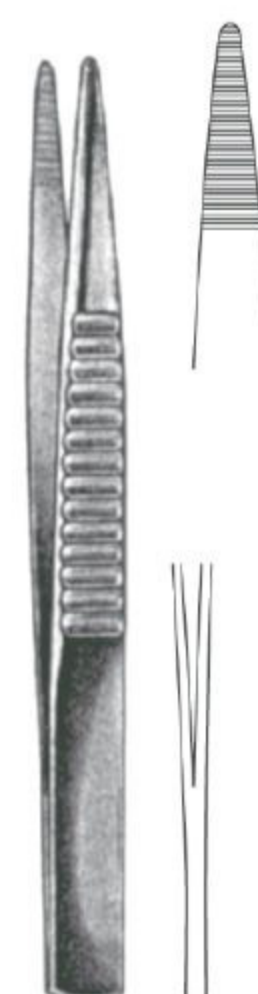

Treves
Block end
06-1908-12 12.0cm
06-1908-15 15.0cm
06-1908-18 18.0cm
06-1908-20 20.0cm
06-1908-25 25.0cm

Dressing Forceps ● EN
 Anatomische Pinzetten ● DE
 Pinzas de diseccion ● ES



Cushing
 06-1909-17 17.0cm 06-1910-17



Potts Smith
 06-1911-18 18.0cm
 06-1911-21 21.0cm
 06-1911-25 25.0cm
 06-1911-30 30.0cm



Waugh
 06-1912-15 15.0cm
 06-1912-18 18.0cm
 06-1912-20 20.0cm



Brophy
 06-1913-20 20.0cm 06-1914-20

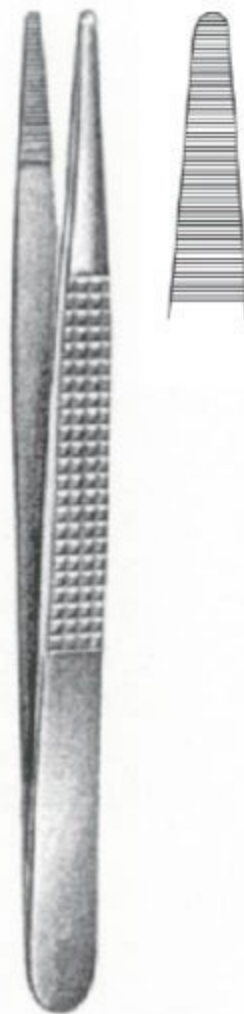

Bonney
 06-1915-17
 17.5cm



Ramsey
 06-1916-18
 18.0cm

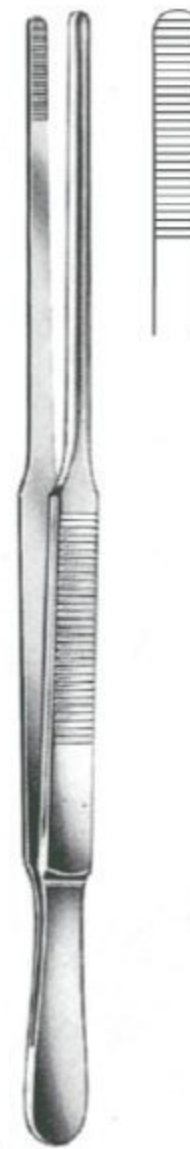

Duehrssen
 06-1917-20
 20.0cm



Wangensteen
 06-1918-23
 23.0cm



Adson
 06-1919-12 12.0cm
 06-1919-15 15.0cm
 06-1919-19 19.0cm



McIndoe
 06-1920-15 15.0cm



Semken
 06-1921-12 12.0cm 06-1922-12
 06-1921-15 15.0cm 06-1922-15



Gerald
 06-1923-18 18.0cm



Gerald
 06-1924-18 18.0cm



Gerald
 06-1925-18 18.0cm



Taylor
 06-1926-17 17.5cm Str
 06-1927-17 17.5cm Cvd



Taylor
06-1928-17
18.5cm



Taylor
06-1929-17
17.5cm



Jefferson
06-1930-18
18.0cm, 180mm



Adson
06-1931-18
18.0cm, 180mm

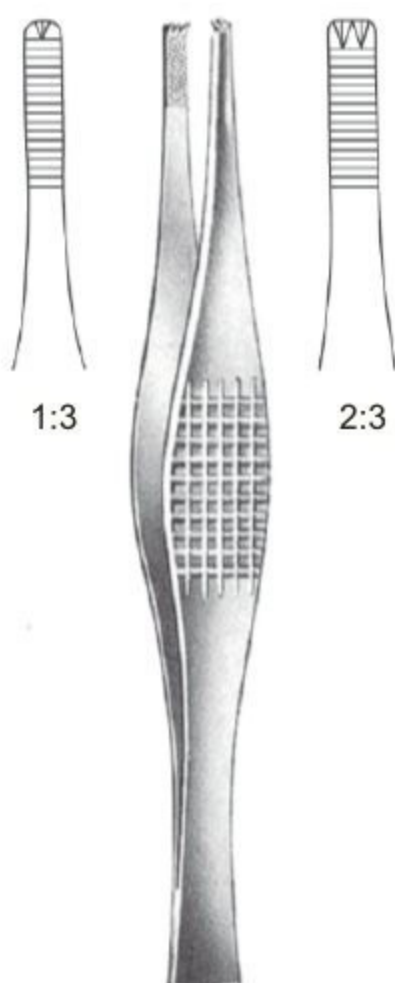

Ferris-Smith
06-1932-18 18.0cm 06-1933-18



Ramsay
18.0cm



Charnley
06-1936-18 18.0cm



Jeans
06-1937-14 14.5cm
06-1937-17 17.5cm



Standard

	Slender 1:2	Delicate 1:2	Regular 1:2	2:3	3:4	4:5
10.0cm			06-1940-10	06-1941-10	06-1942-10	06-1943-10
11.0cm	06-1938-11		06-1940-11	06-1941-11	06-1942-11	06-1943-11
13.0cm	06-1938-13	06-1939-13	06-1940-13	06-1941-13	06-1942-13	06-1943-13
14.0cm	06-1938-14	06-1939-14	06-1940-14	06-1941-14	06-1942-14	06-1943-14
16.0cm	06-1938-16	06-1939-16	06-1940-16	06-1941-16	06-1942-16	06-1943-16
18.0cm	06-1938-18	06-1939-18	06-1940-18	06-1941-18	06-1942-18	06-1943-18
20.0cm	06-1938-20	06-1939-20	06-1940-20	06-1941-20	06-1942-20	06-1943-20
23.0cm			06-1940-23			
25.0cm			06-1940-25	06-1941-25	06-1942-25	06-1943-25
30.0cm			06-1940-30	06-1941-30	06-1942-30	06-1943-30



USA Model

12.0cm	06-1944-12			
13.0cm	06-1944-13	06-1945-13	06-1946-13	06-1947-13
14.0cm	06-1944-14	06-1945-14	06-1946-14	06-1947-14
15.0cm	06-1944-15	06-1945-15	06-1946-15	06-1947-15
18.0cm	06-1944-18			
21.0cm	06-1944-21			
25.0cm	06-1944-25			
31.0cm	06-1944-31			

Tissue Forceps ●— EN
 Chirurgische Pinzetten ●— DE
 Pinzas de diseccion con dientes ●— ES

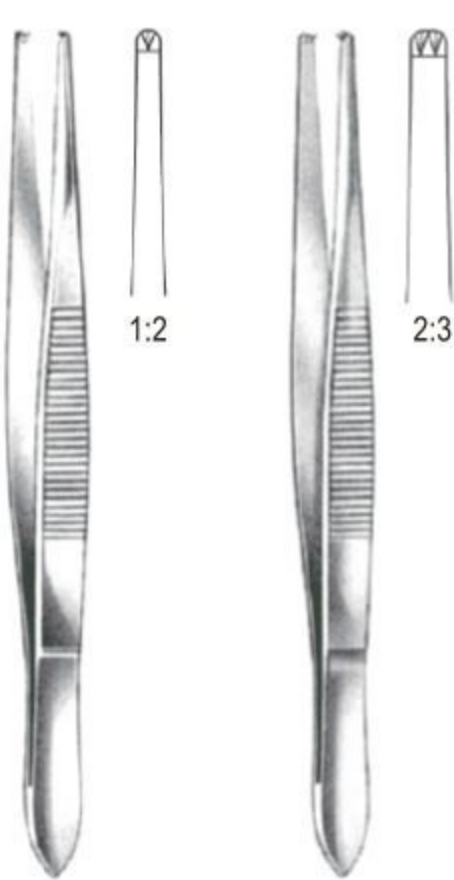

Stille
 06-1948-15 15.0cm
 06-1948-15 15.0cm



Treves
 06-1949-12 12.5cm
 06-1949-15 15.0cm
 06-1949-18 18.0cm
 06-1949-20 20.0cm
 06-1949-25 25.0cm

Adlerkreutz

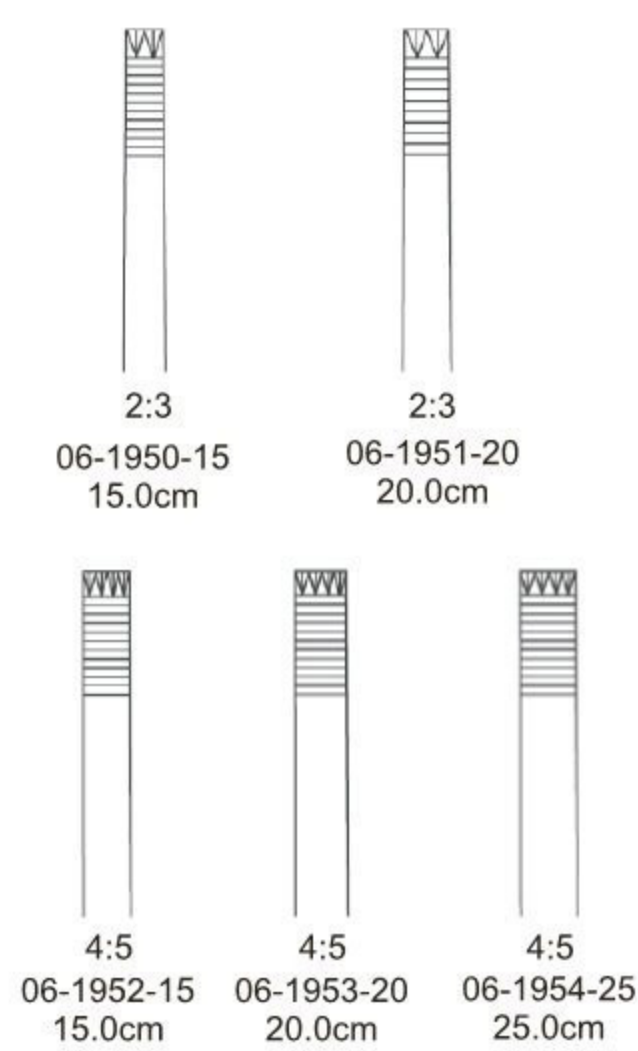

06-1950-15 15.0cm
 06-1951-20 20.0cm
 06-1952-15 15.0cm
 06-1953-20 20.0cm
 06-1954-25 25.0cm

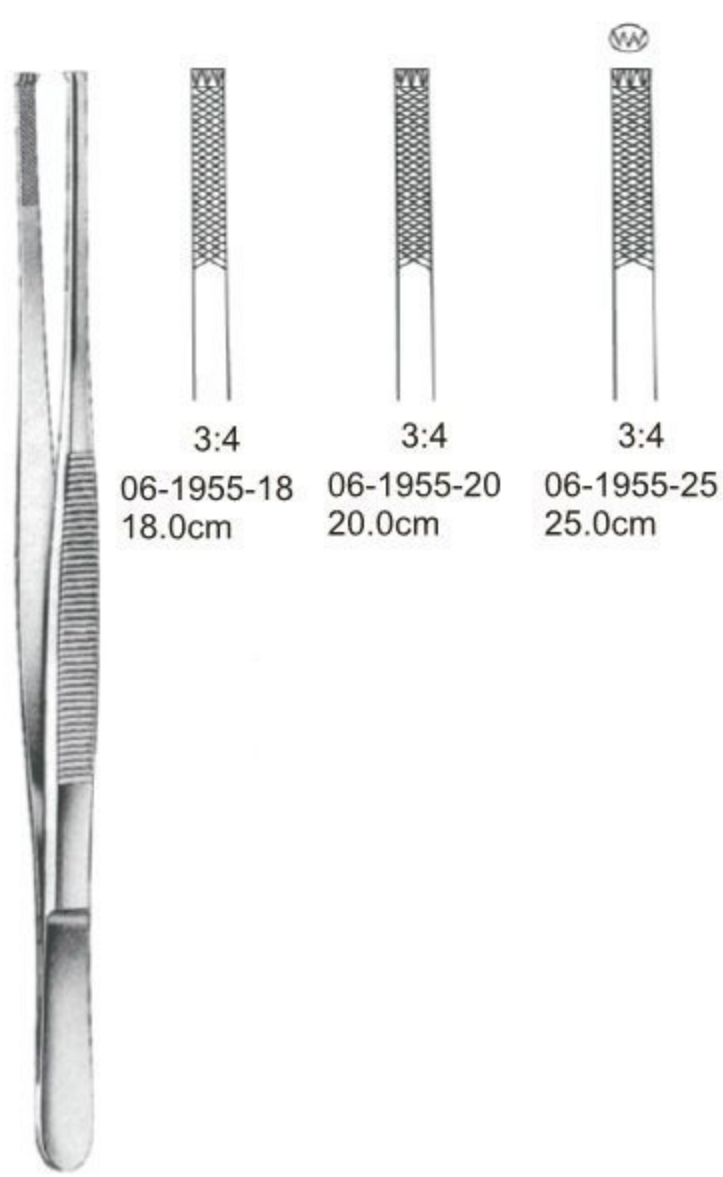

Stille-Barraya

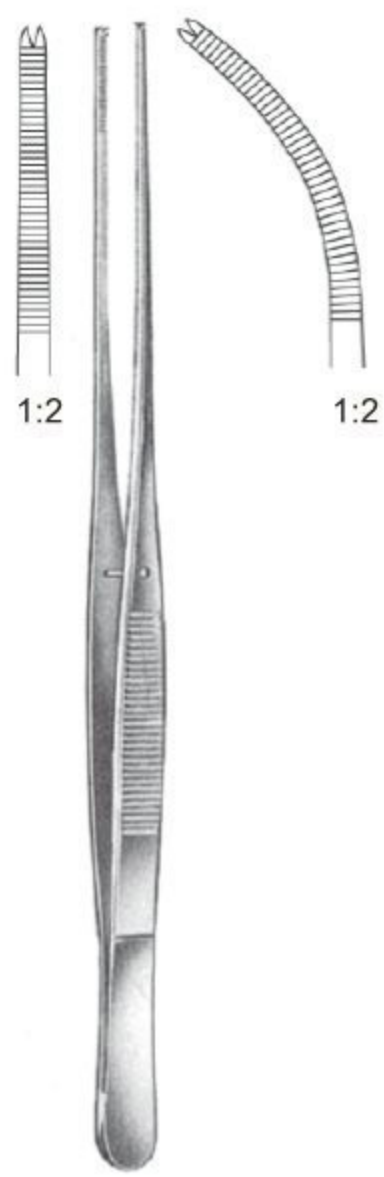

Brophy
 06-1956-20 20.0cm 06-1957-20

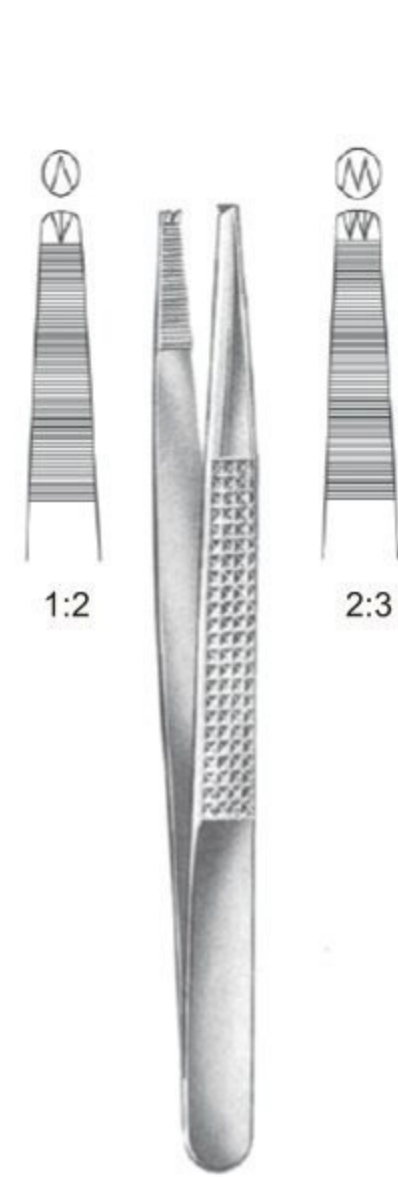

Bonney
 06-1958-18 18.0cm 06-1959-18

- EN —● Tissue Forceps
- DE —● Chirurgische Pinzetten
- ES —● Pinzas de diseccion con dientes



Adson
06-1960-18 18.0cm

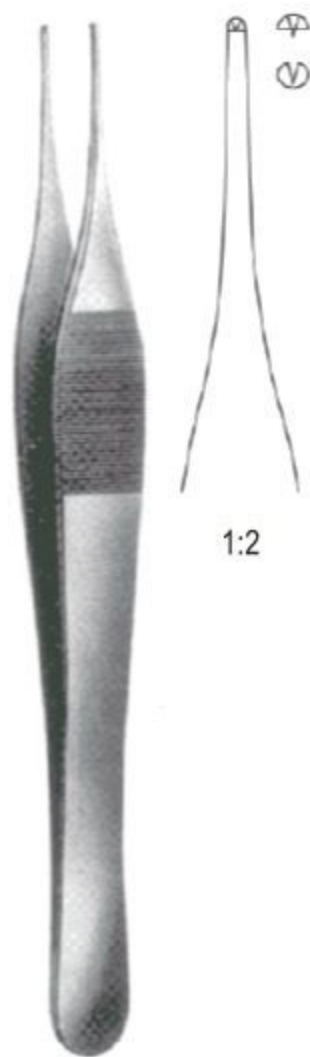

Jefferson
06-1961-18 18.0cm

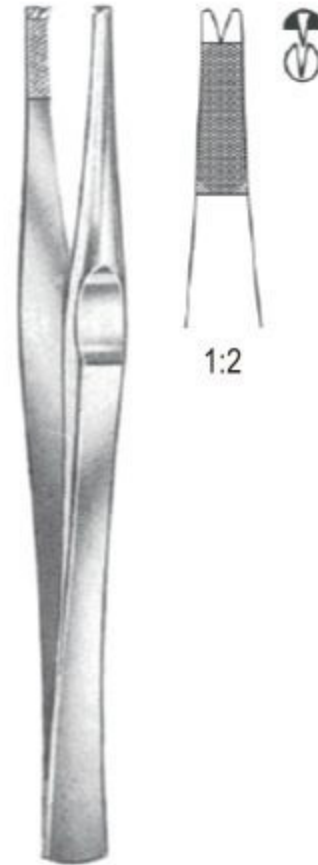

Lanes
06-1962-12 12.5cm
06-1962-15 15.0cm
06-1962-18 18.0cm
06-1962-20 20.0cm

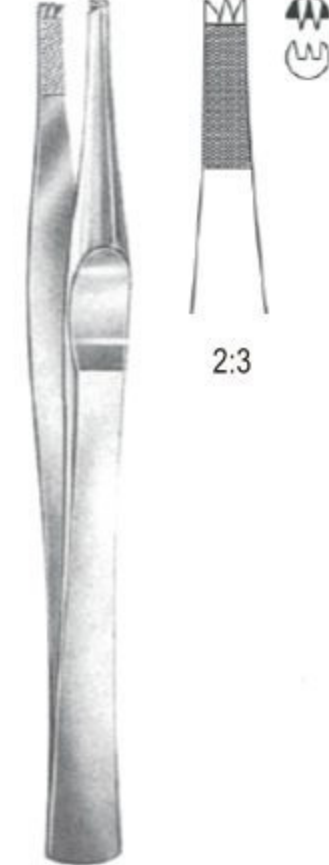

Lanes
06-1963-12 12.5cm
06-1963-15 15.5cm
06-1963-18 18.0cm
06-1963-20 20.0cm

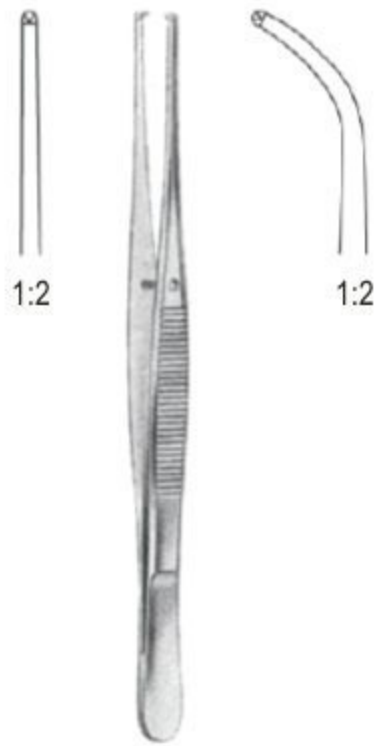

Semken
06-1964-12 12.5cm 06-1965-12 12.5cm
06-1964-15 15.0cm 06-1965-15 15.0cm

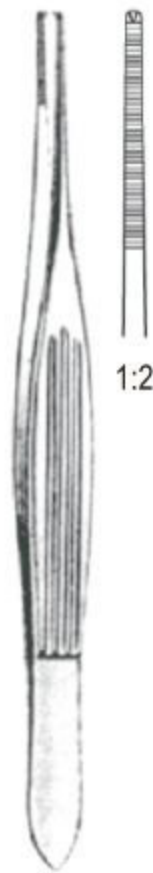

McIndoe

06-1966-15 15.0cm 06-1967-15 15.0cm

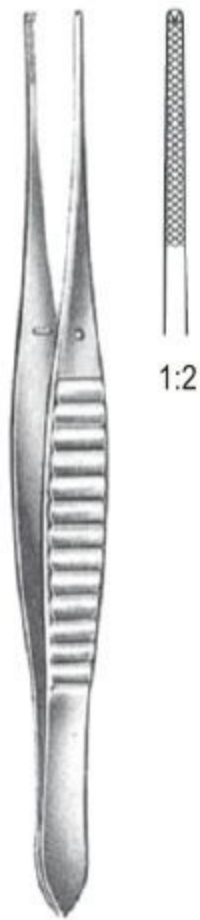

Gillies

06-1967-15 15.0cm

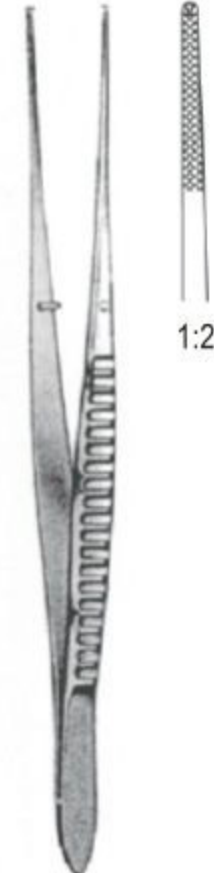

Waugh

06-1968-15 15.0cm
06-1968-18 18.0cm
06-1968-20 20.0cm



Potts Smith

06-1969-18 18.0cm
06-1969-21 21.0cm
06-1969-25 25.0cm
06-1969-30 30.0cm

Tissue Forceps ●— EN
 Chirurgische Pinzetten ●— DE
 Pinzas de diseccion con dientes ●— ES

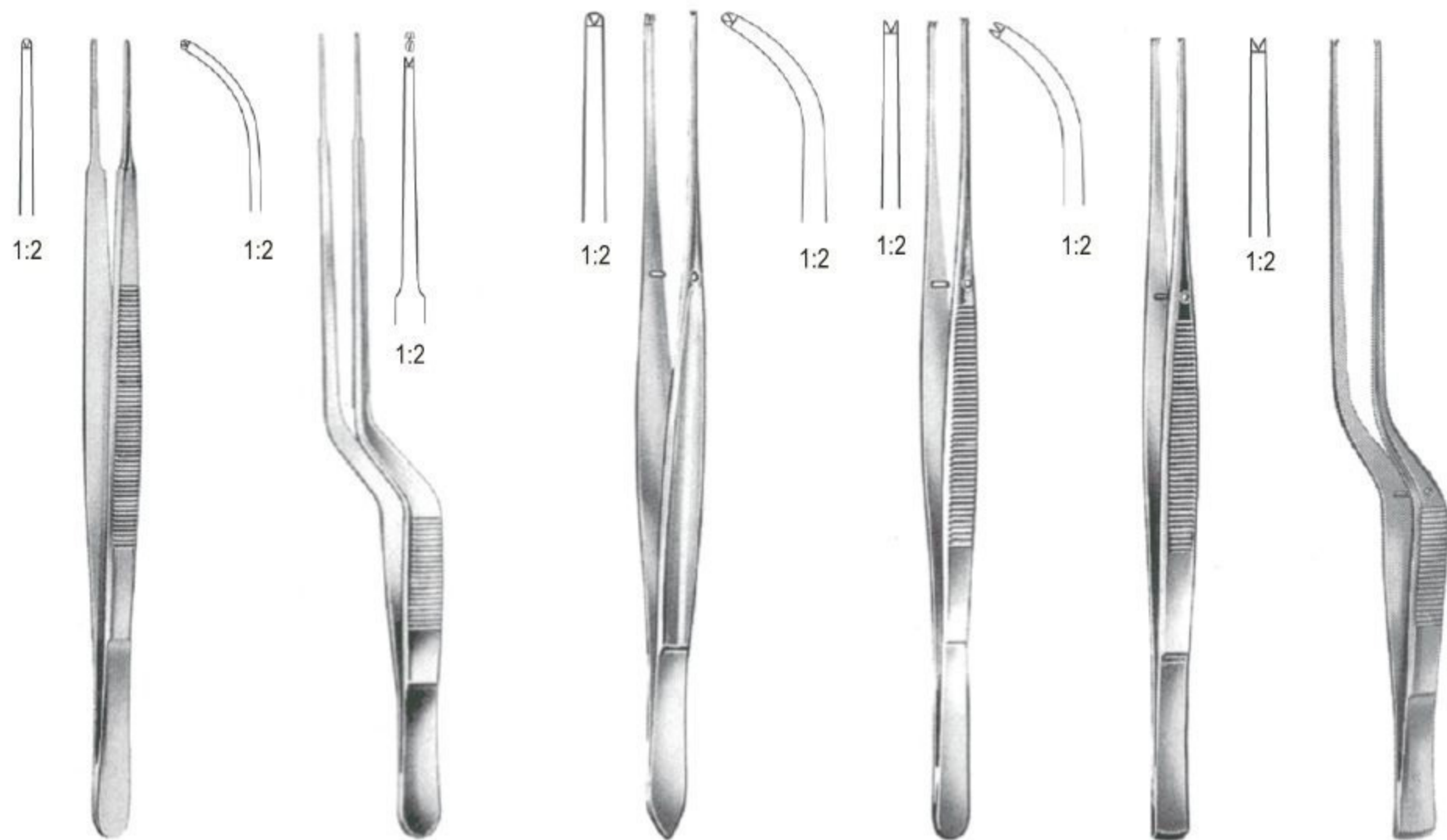

Gerald
 06-1970-18 18.0cm
 06-1970-18 18.0cm

Gerald
 06-1971-18 18.0cm

Cushing
 06-1972-17 17.5cm
 06-1972-17 17.5cm

Taylor
 06-1973-17 17.5cm
 06-1973-17 17.5cm

Taylor
 06-1974-17 17.5cm

Taylor
 06-1975-17 17.5cm

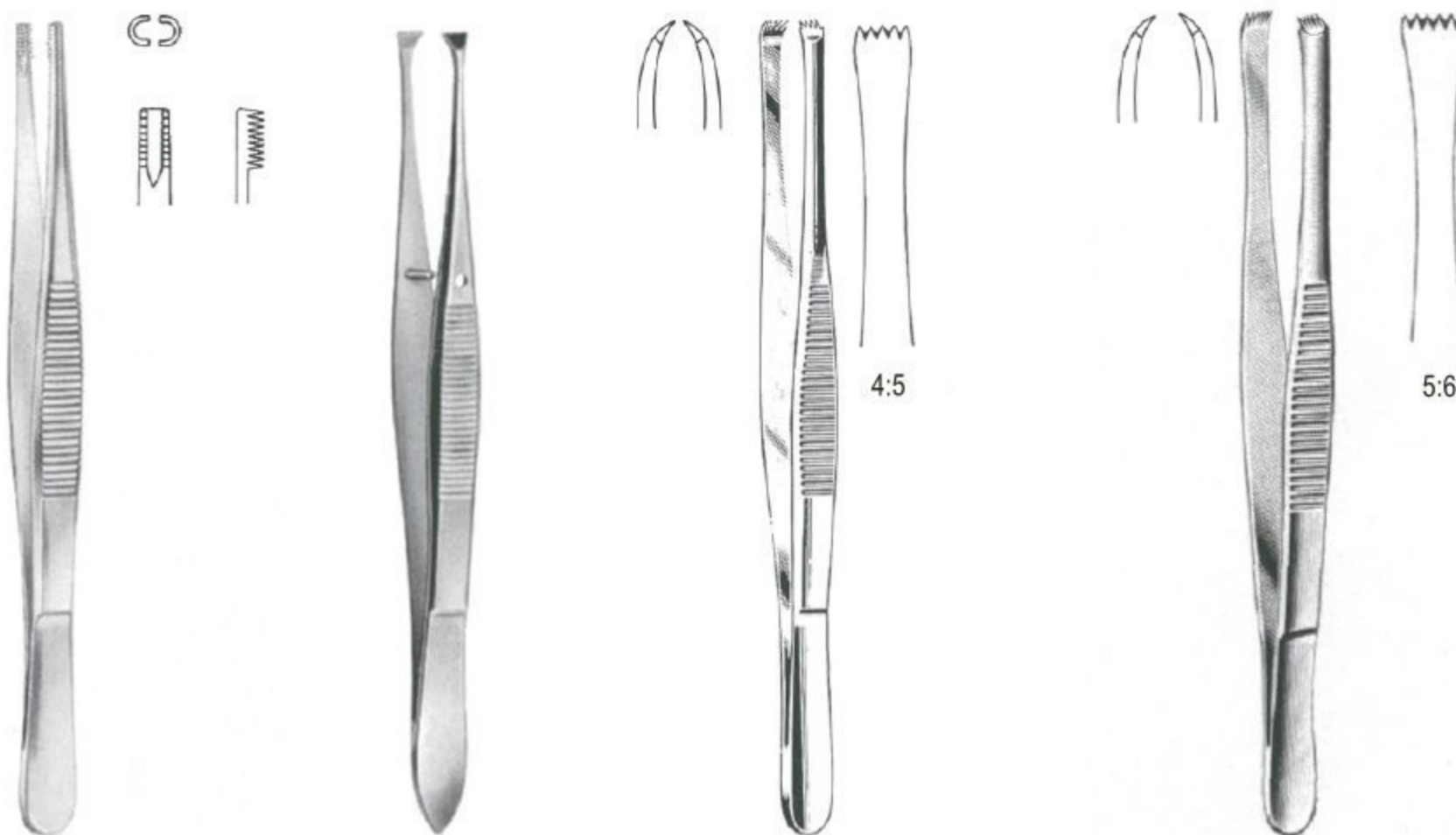

Brown
 06-1976-15 15.0cm
 06-1976-20 20.0cm
 06-1976-25 25.0cm

Graefe
 06-1977-10 10.0cm

Stone
 06-1978-15 15.0cm

Lerche
 06-1979-15 15.0cm

- EN —● Tissue, Tumor Forceps
- DE —● Chirurgische, Fasspinzetten
- ES —● Pinzas, para coger diseccion con dientes

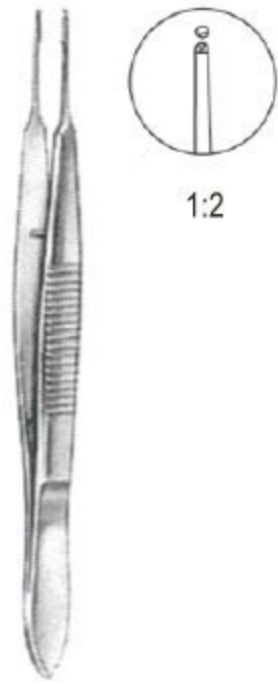

06-1980-11
11.0cm

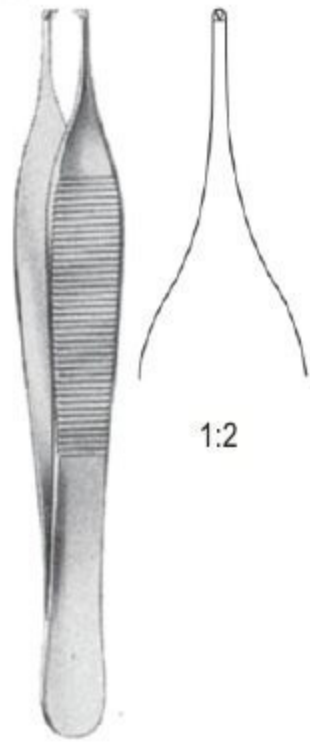

Adson
06-1981-12 12.0cm
06-1981-15 15.0cm

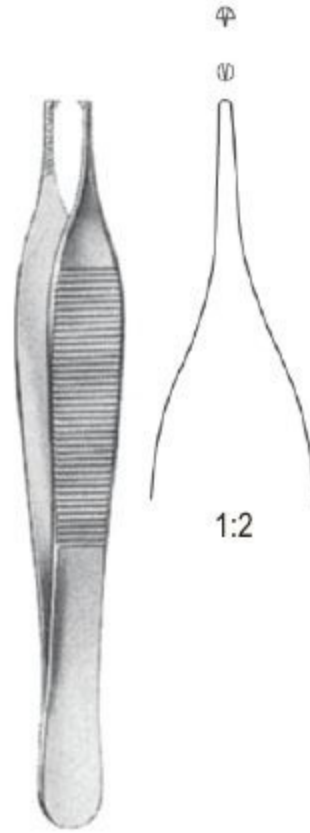

Adson
06-1982-12 12.0cm

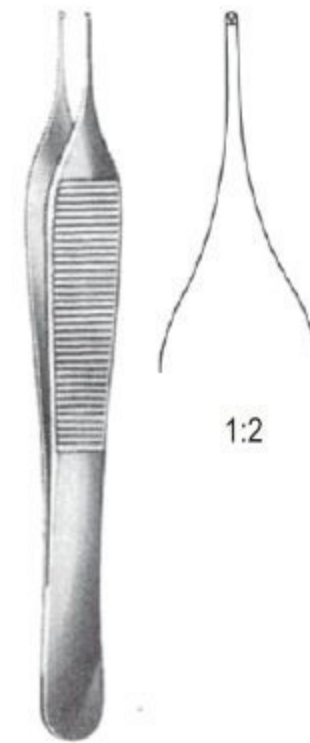

Micro-Adson
06-1983-12 12.0cm



Adson-Brown
06-1984-12 12.0cm



Durante

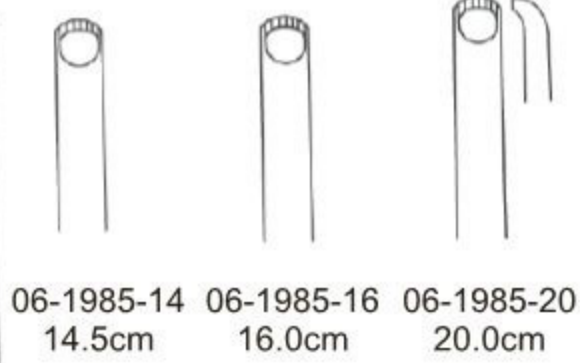

06-1985-14 14.5cm
06-1985-16 16.0cm
06-1985-20 20.0cm



Russ Modell

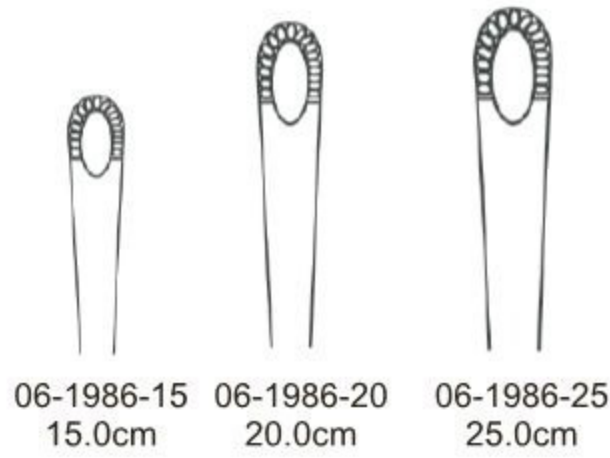

06-1986-15 15.0cm
06-1986-20 20.0cm
06-1986-25 25.0cm



Mayo Russ
06-1987-23 23.0cm

Tissue, Tumor Forceps ●— EN
 Chirurgische, Fasspinzetten ●— DE
 Pinzas, para coger diseccion con dientes ●— ES



Micro Adson
 06-1988-12 12.0cm



06-1989-12 12.0cm 06-1990-12 12.0cm
 06-1989-16 16.0cm 06-1990-16 16.0cm

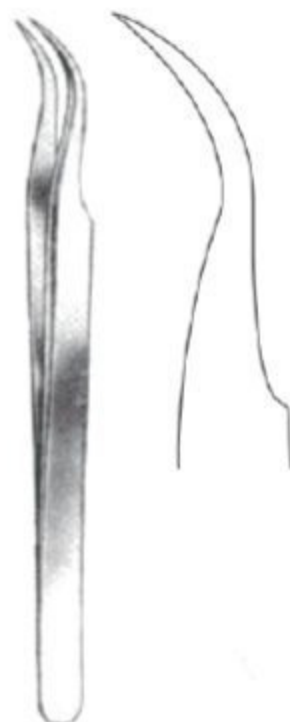

10 cm
 11.5cm



06-1991-01
 06-1991A-01



06-1991-02
 06-1991A-02



06-1991-03
 06-1991A-03



1:2
 06-1992-01
 06-1992A-01



1:2
 06-1992-02
 06-1992A-02



1:2
 06-1992-03
 06-1992A-03



Yasargil
 22.0cm

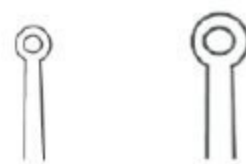

06-1993-03 3mm Ø 06-1993-05 5mm Ø



Yasargil
 22.0cm



06-1994-03 3mm Ø 06-1994-05 5mm Ø



Heifetz
 22.0cm



06-1995-03 3mm Ø 06-1995-05 5mm Ø

- EN —● Tissue and Micro Forceps, Fine Pattern
- DE —● Chirurgische und Mikro-Pinzetten, feine modelle
- ES —● De diseccion con dientes micro-pinzas, modelos finos

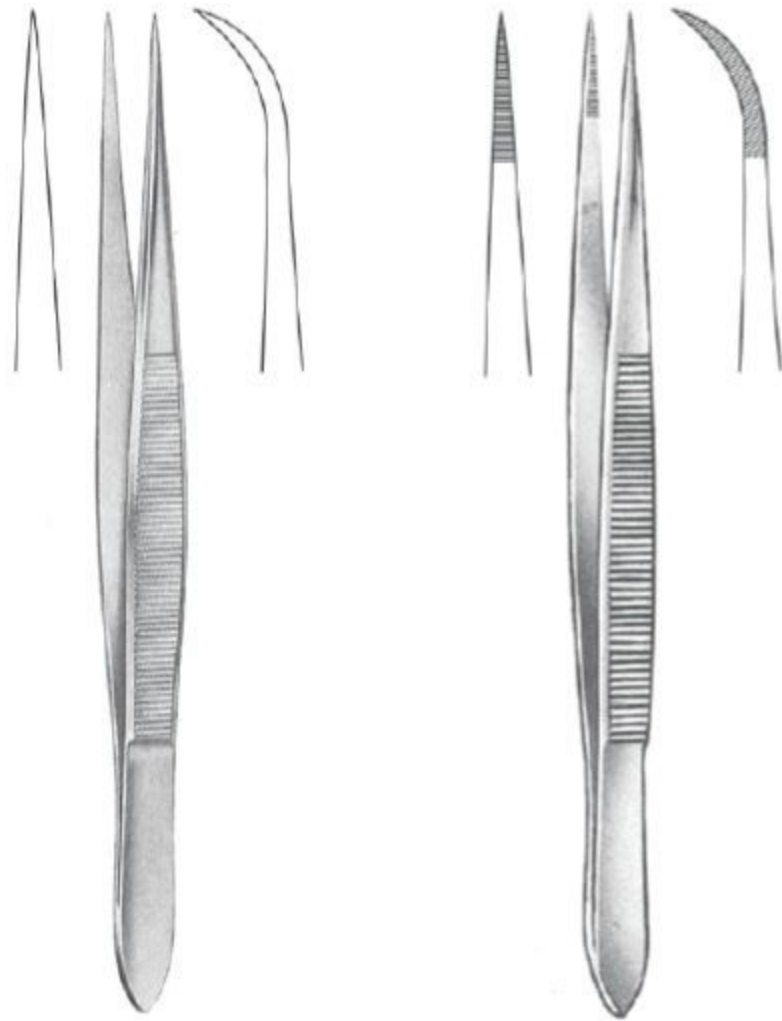

06-1996-09	09.0cm	06-1997-09	06-1998-09	09.0cm	06-1999-09
06-1996-10	10.5cm	06-1997-10	06-1998-10	10.5cm	06-1999-10
06-1996-11	11.5cm	06-1997-11	06-1998-11	11.5cm	06-1999-11
06-1996-12	12.0cm	06-1997-12	06-1998-12	12.0cm	06-1999-12



06-2000-18

Gomel
18.0cm



1:2



06-2001-18



22.5cm



06-2002-01



06-2002-02



18.5cm

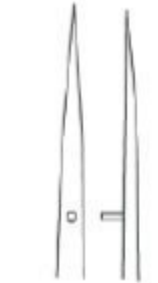

06-2003-01

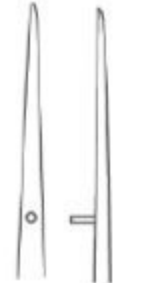

06-2003-02



06-2003-03



15.5cm



06-2004-16

- Splinter Forceps ●— EN
- Spitter-Pinzetten ●— DE
- Pinzas para espinas ●— ES



06-2005-12
12.0cm



Feilchenfeld



06-2006-07
7.5cm



06-2006-09
9.0cm



06-2006-20
11.5cm



06-2007-12
12.5cm



06-2008-10



Hunter
10.5cm



06-2009-10



06-2010-10



Walter-Carmalt
10.5cm



06-2011-10

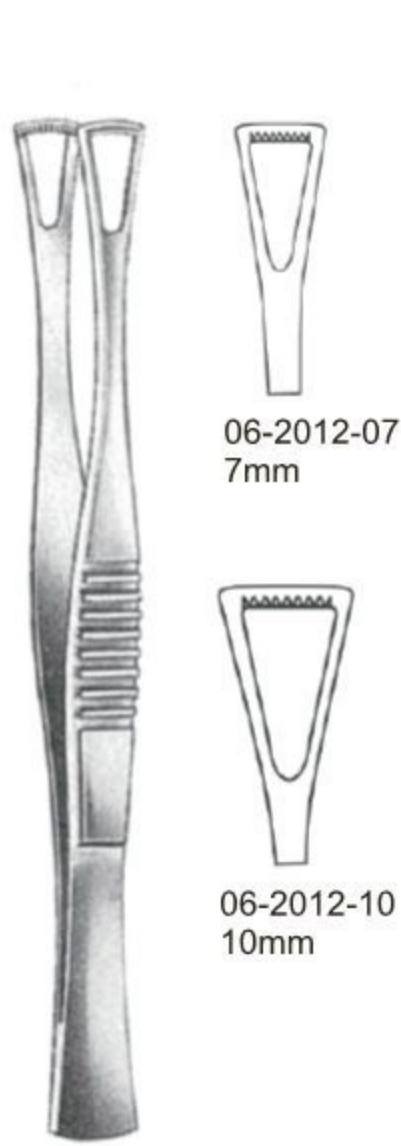

Duval
14.5cm

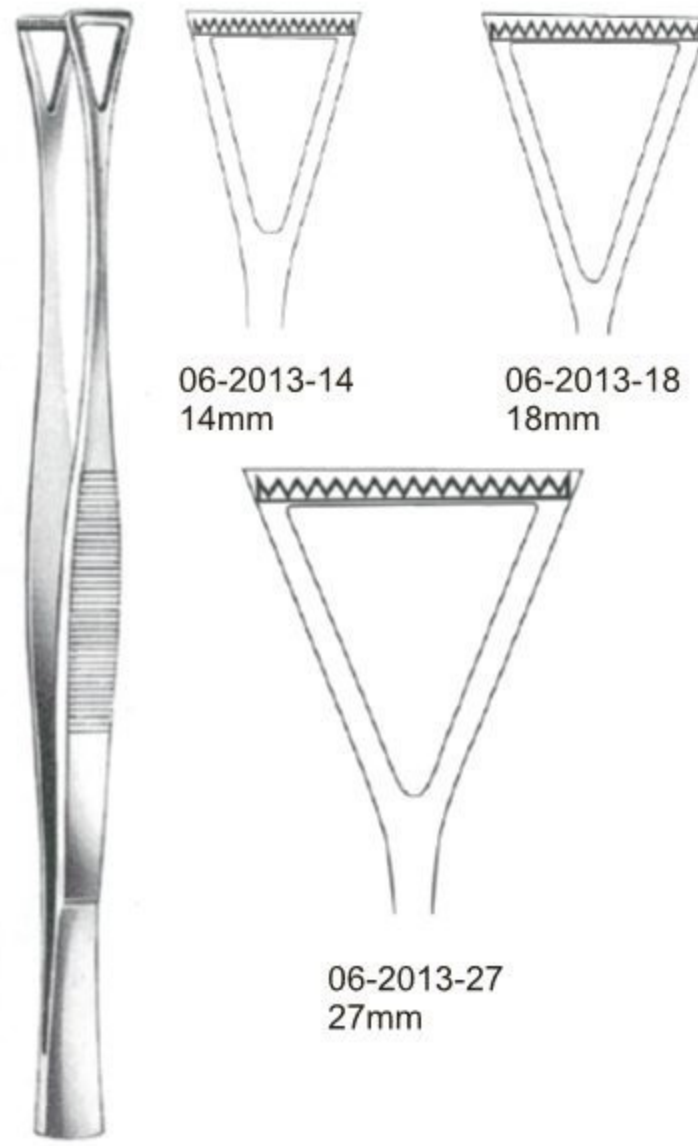

Collin-Duval
20.0cm



Hepp/Scheidel
06-2014-18 18.0cm



Singley-Tuttle
06-2015-23 23.0cm



Nelson
06-2016-23 23.0cm



06-2017-21
21.0cm

Cilia Forceps ● EN
 Cillenpinzetten ● DE
 Pinzas depilatorias ● ES



Beer
 06-2018-09 9.0cm



Littauer
 06-2019-08 8.5cm



06-2020-09 9.0cm



Douglas
 06-2021-09 9.0cm



Douglas
 06-2022-09 9.0cm



Barraquer
 06-2023-10 10.5cm



Gradle
 06-2024-09 9.5cm



Henry
 06-2025-12 12.0cm



Peet
06-2026-11 11.5cm

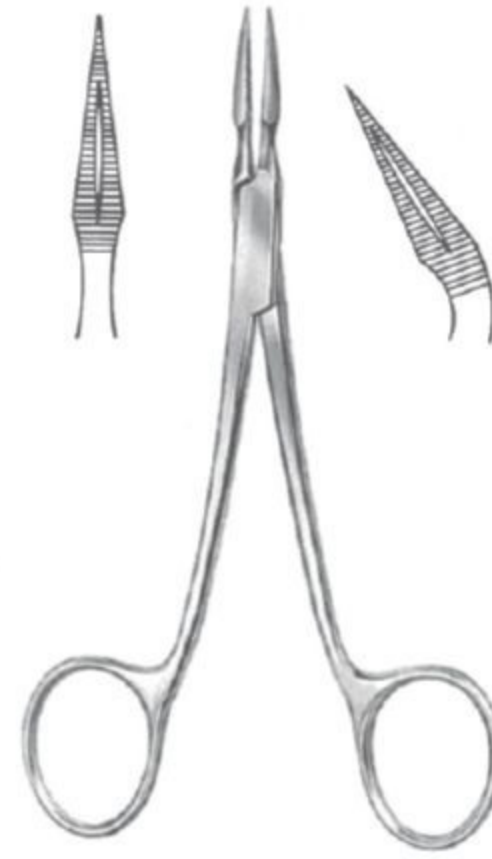

Arther
06-2027-14 14.0cm 12.0401.14

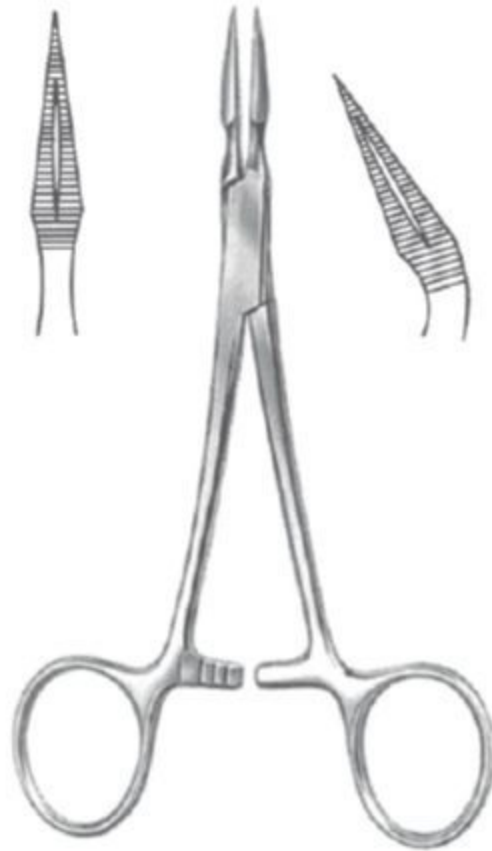

Stieglitz
06-2028-13 13.5cm 06-2029-13

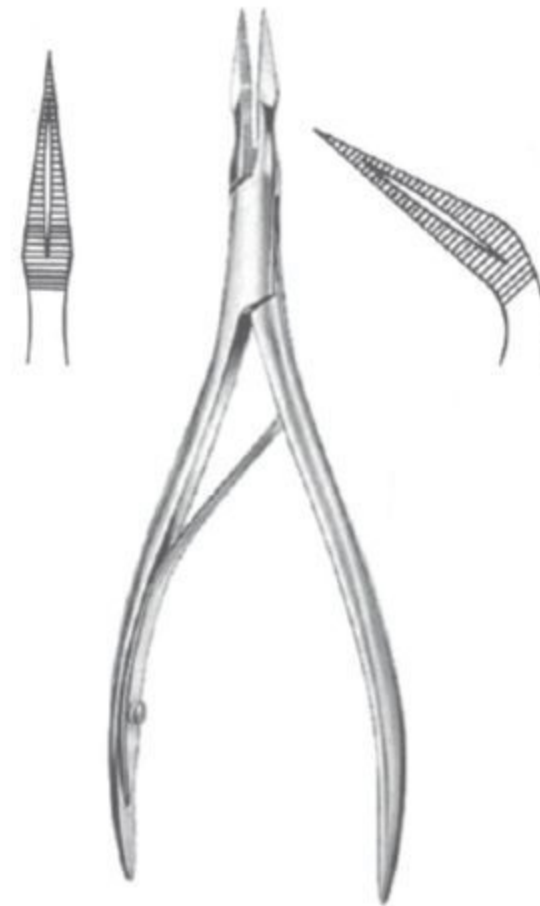

Ralk
06-2030-15 15.0cm 06-2031-15

Dressing Forceps ● EN
 Anatomische Pinzetten ● DE
 Pinzas de diseccion ● ES



Standard
 06-2032-14 14.5cm/5 3/4"
 06-2032-16 16cm/6 1/4"
 06-2032-18 18cm/7"
 06-2032-20 20cm/8"
 06-2032-25 25cm/10"

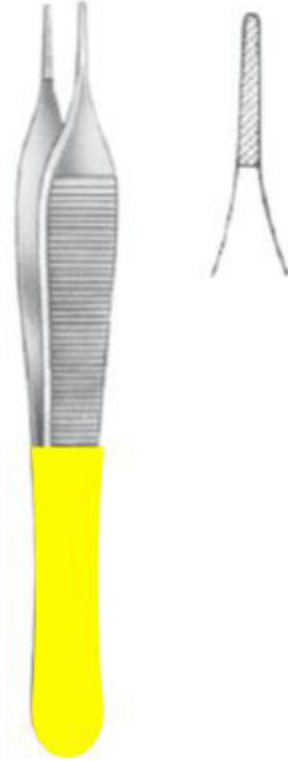

Adson
 06-2033-12 12cm/4 3/4"
 06-2033-15 15.5cm/6"



McIndoe
 06-2034-15 15cm/6"



Semken
 06-2035-12 12cm/4 3/4"
 06-2035-15 15cm/6"



06-2036-18 18cm/7"



Cushing
 06-2037-18 18cm/7"



Cushing-Taylor
 06-2038-18 18cm/7"



Grunwald
 06-2039-18 18cm/7"



Wangensteen
 06-2040-15 15cm/6"
 06-2040-23 13cm/9"
 06-2040-25 25cm/10"



06-2041-15 15cm/6"
 06-2041-18 18cm/7"
 06-2041-20 20cm/8"
 06-2041-23 23cm/9"
 06-2041-25 25cm/10"



Oehler
 1:2
 06-2042-14 14.5cm/5 1/2"
 06-2042-16 16cm/6 1/4"
 06-2042-18 18cm/7"
 06-2042-20 20cm/8"
 06-2042-25 25cm/10"
 06-2042-30 30cm/12"



Micro-Adson
 06-2043-12 12cm/4 3/4"
 06-2043-15 15.5cm/6"



Standard-Adson
 06-2044-12 12cm/4 3/4"
 06-2044-15 15.5cm/6"



Adson-Brown
 06-2045-12
 12cm/4 3/4"



Gillies
 06-2046-15
 15 cm/6"