



- EN** Artery Forceps
- DE** Arterienklemmen
- ES** Pinzas hemostáticas

Page 112 to 140





**Terrier**  
 07-2101-10  
 10 cm/4"



**Pennington**  
 07-2102-15 15 cm/6"  
 07-2102-20 20 cm/8"



**Peau**  
 07-2103-12  
 12.5 cm/5"

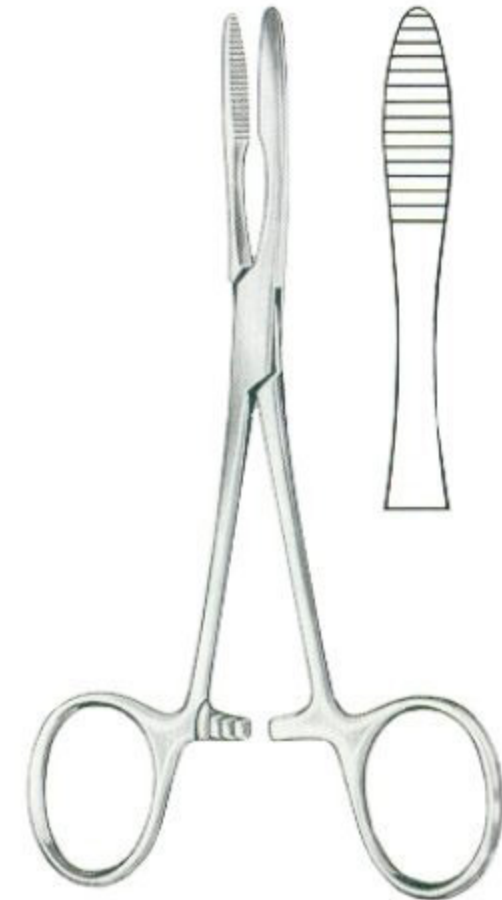

**Peau**  
 07-2104-14 14 cm/5 3/4  
 07-2104-16 16 cm/6 1/4



**Peau**  
 07-2105-14  
 14 cm/5 1/2"



**Collin**  
 07-2106-15  
 15.5 cm/6"



**Collin**  
 07-2107-14  
 14 cm/5 1/2"



**Collin**  
 07-2108-16  
 16.5 cm/6 1/2"



**Hartmann**  
10 cm/4"



**Halstead-Mosquito**  
12 cm/4¾"  
14 cm/5½"

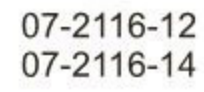
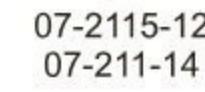
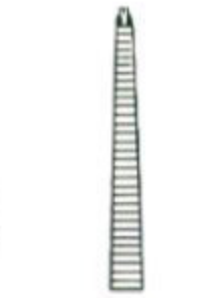
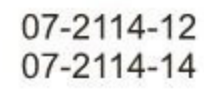
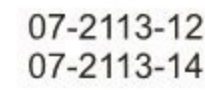

**Micro-Mosquito**  
10 cm/4"  
12 cm/4¾"

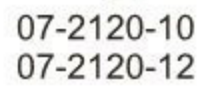
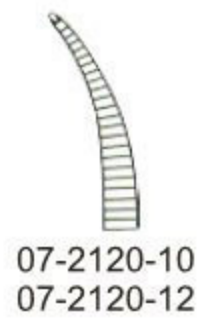
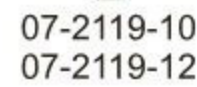
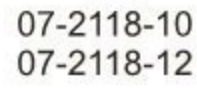
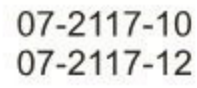
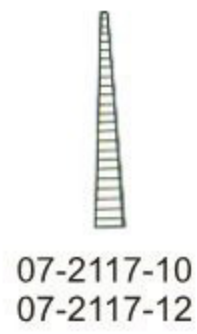

**Jacobson-Halstead**  
13 cm/5"

Very fine



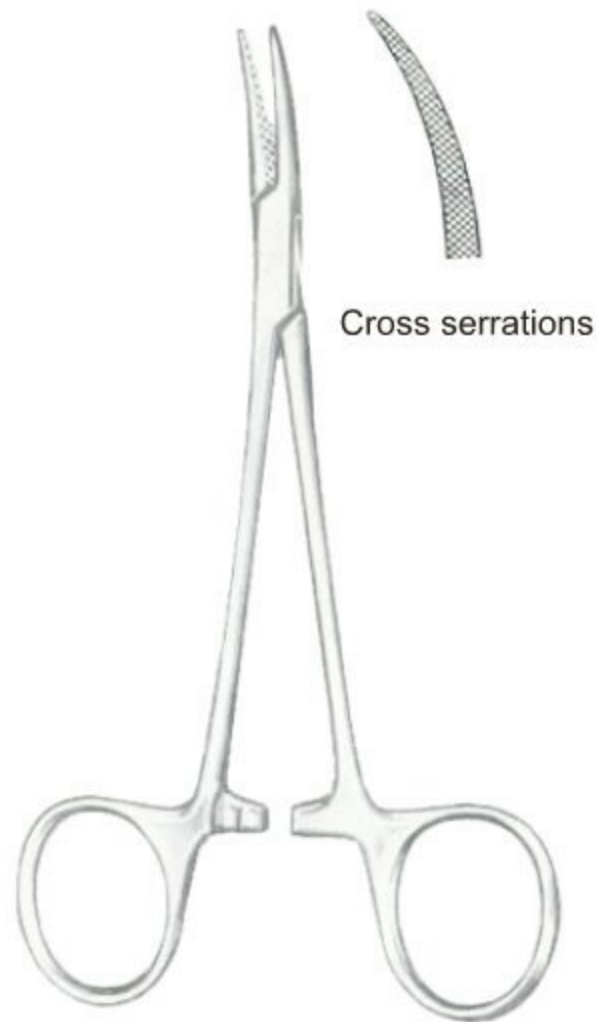

Cross serrations

07-2123-12  
 12 cm/4¾"



**Halstead-Mosquito**  
 18 cm/7"  
 21 cm/8¼"



07-2124-18  
 07-2124-21



07-2125-18  
 07-2125-21



07-2126-18  
 07-2126-21



07-2127-18  
 07-2127-21



**Kelly**  
 14 cm/5½"

**Kelly-Rankin**  
 16 cm/6¼"

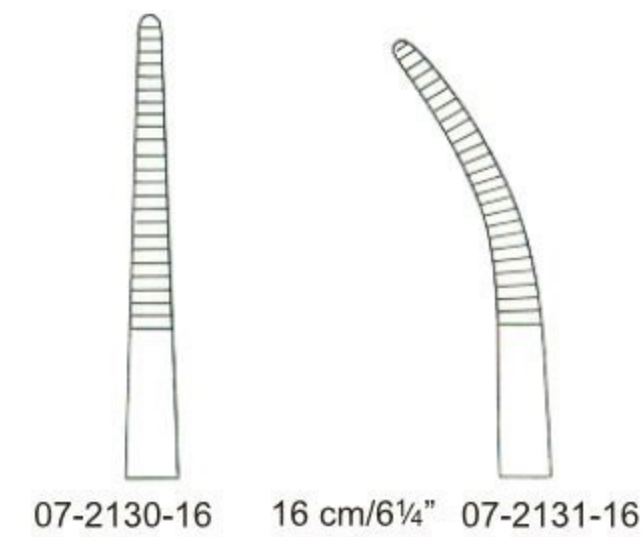
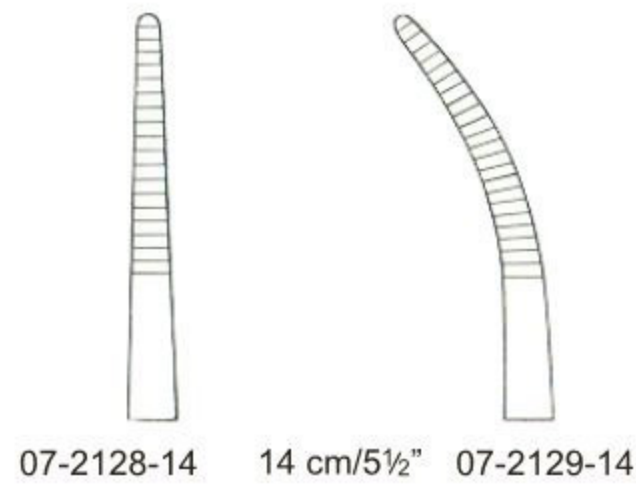



**Crile**  
14 cm/5½"

**Crile-Rankin**  
16 cm/6¼"

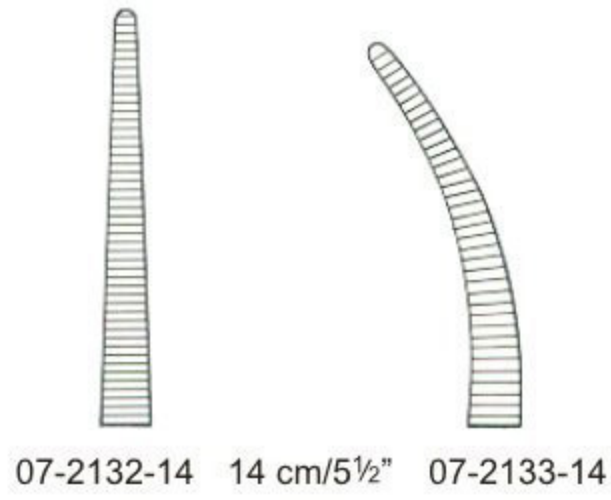

07-2132-14 14 cm/5½" 07-2133-14

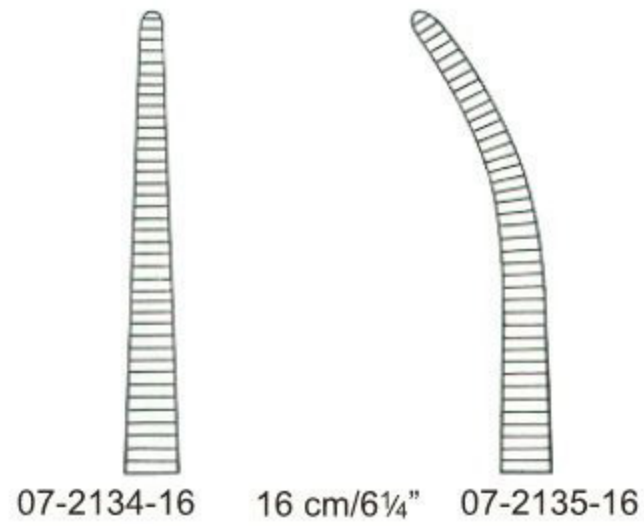

07-2134-16 16 cm/6¼" 07-2135-16



**Baby-Crile**  
14 cm/5½"

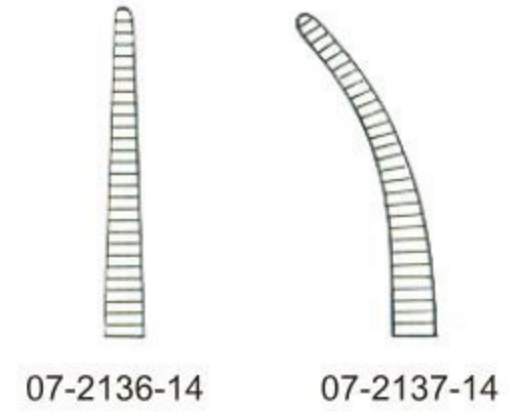

07-2136-14 07-2137-14



**Crile**  
14 cm/5½"

**Crile-Rankin**  
16 cm/6¼"

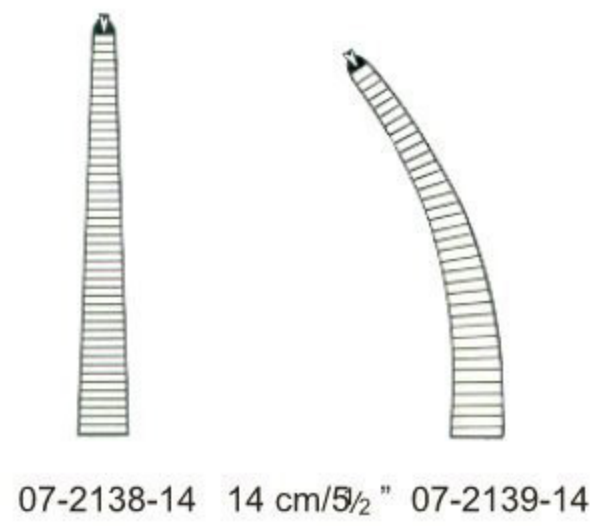

07-2138-14 14 cm/5½" 07-2139-14

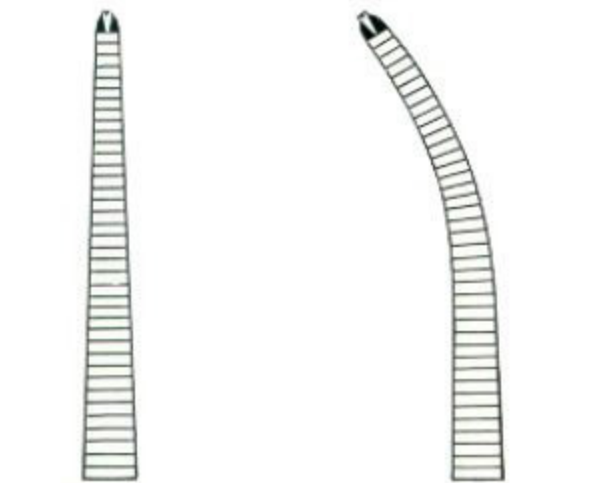

07-2140-16 16 cm/6¼" 07-2141-16



**Baby-Crile**  
14 cm/5½"

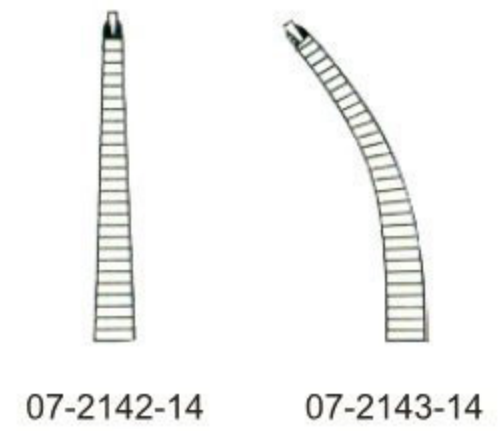

07-2142-14 07-2143-14



**Coller-Crile**

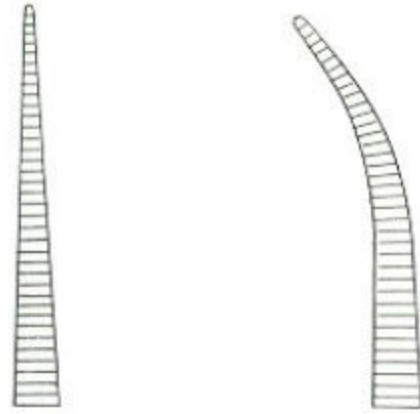

07-2144-14 14 cm/5½" 07-2145-14

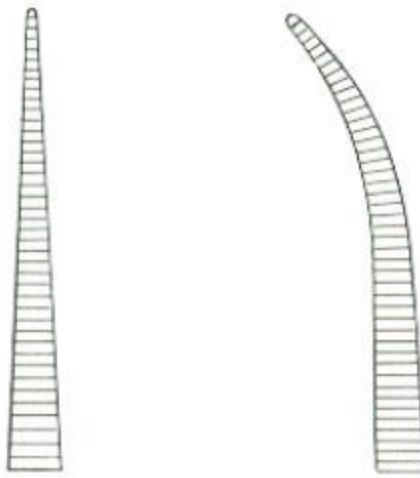

07-2146-16 16 cm/6¼" 07-2146-16



**Coller-Crile**  
07-2147-16  
16 cm/6¼"



**Leriche**  
15 cm/6"

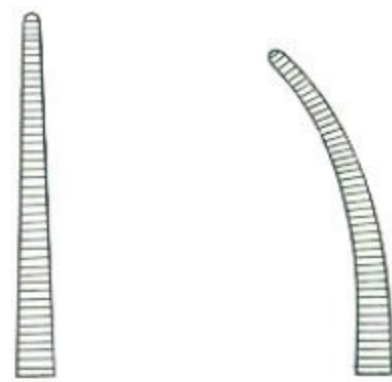

07-2148-15 07-2149-15

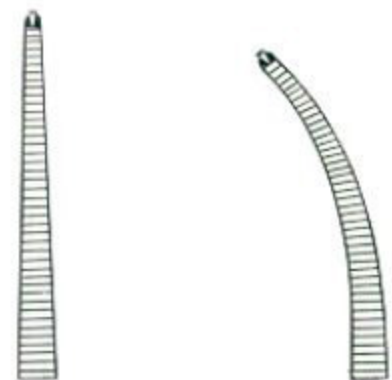

07-2150-15 07-2151-15



**Providence**  
14 cm/5½"



07-2152-14



07-2153-14

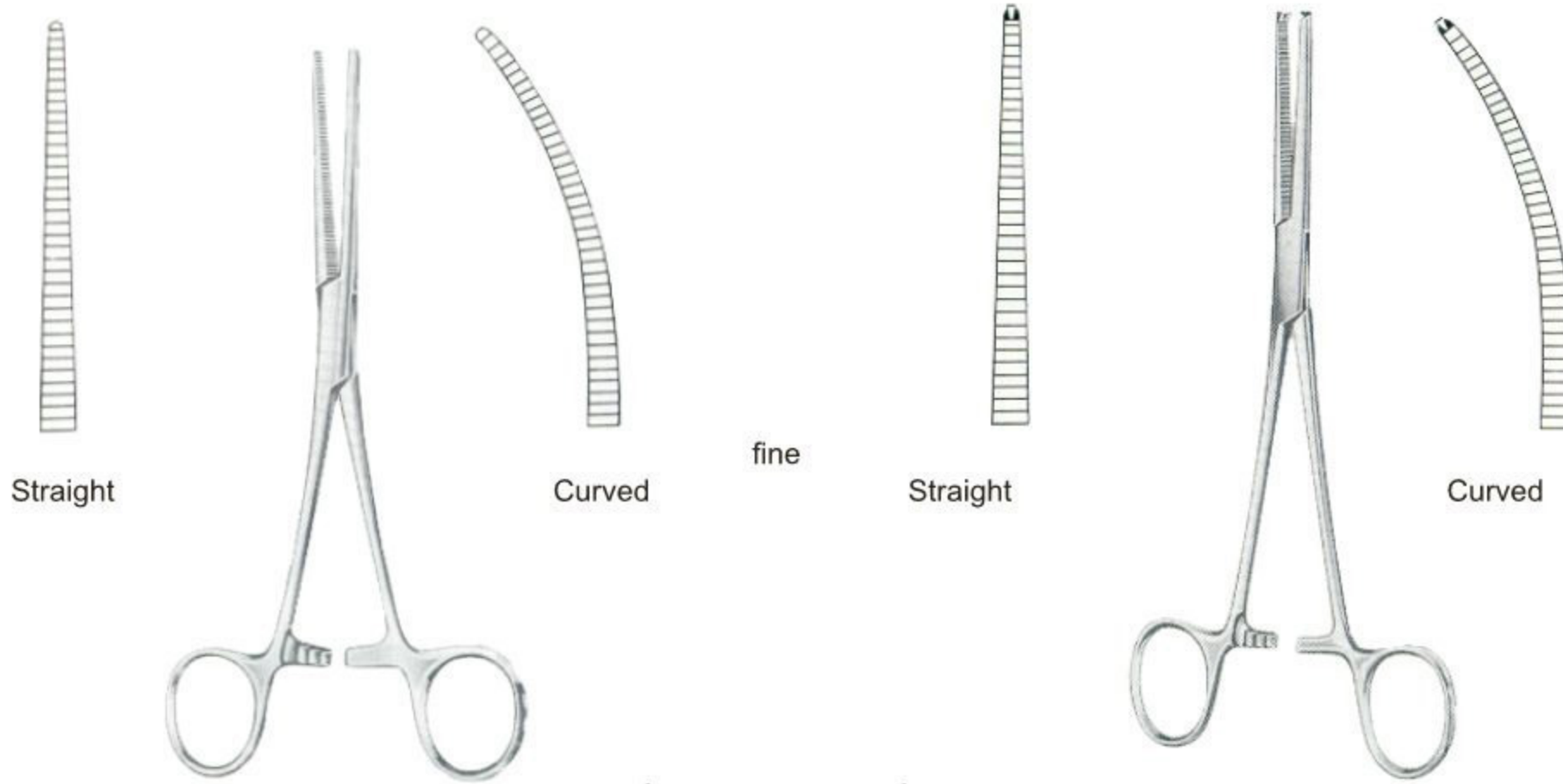

Rochester-Pean		cm	in	Ochsner-Kocher	
07-2154-13	07-2155-13	13.0	5"	07-2156-13	07-2157-13
07-2154-14	07-2155-14	14.0	5 1/2"	07-2156-14	07-2157-14
07-2154-16	07-2155-16	16.0	6 1/4"	07-2156-16	07-2157-16

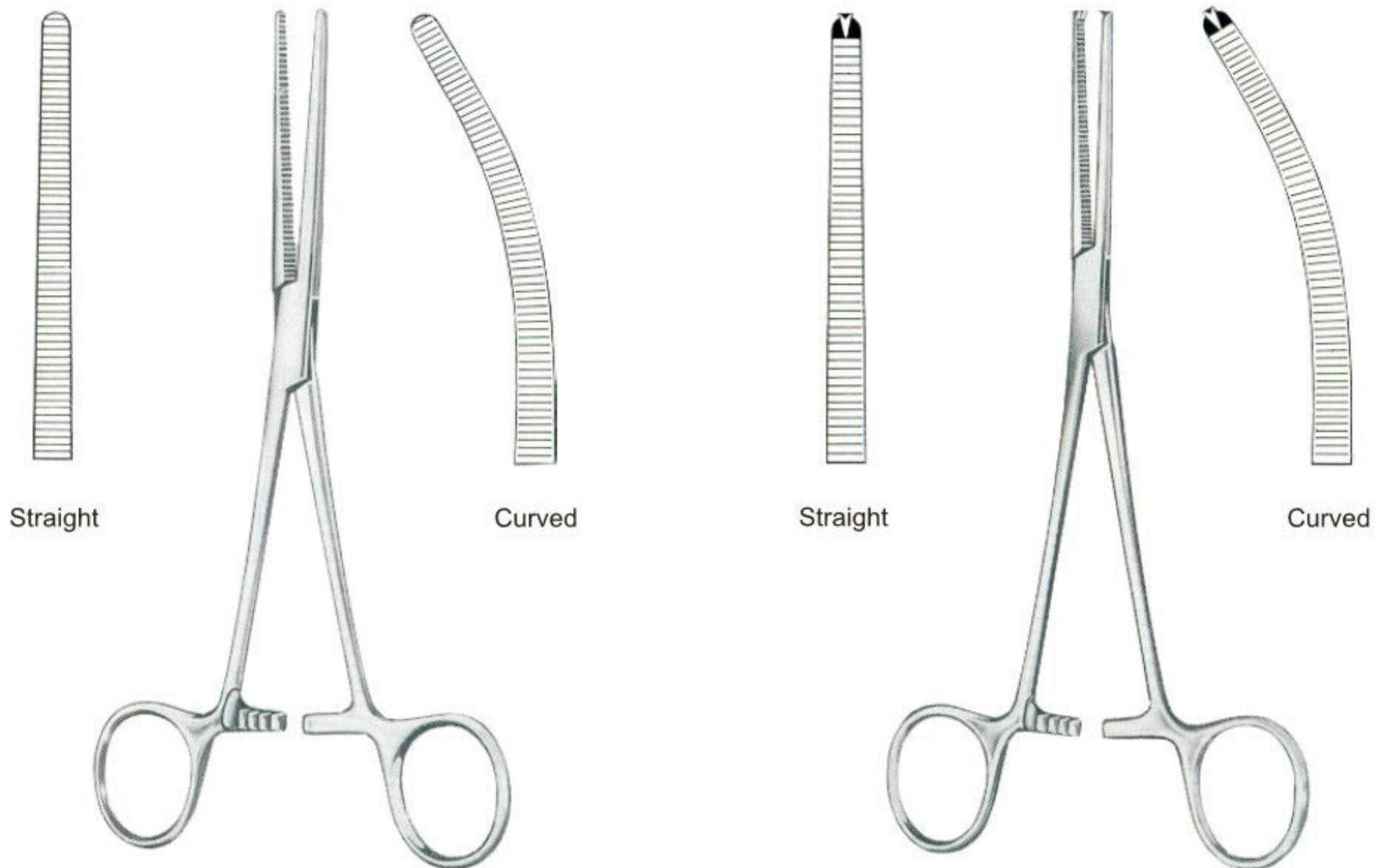

Rochester-Pean		cm	in	Ochsner-Kocher	
07-2158-13	07-2159-13	13.0	5"	07-2160-13	07-2161-13
07-2158-14	07-2159-14	14.0	5 1/2"	07-2160-14	07-2161-14
07-2158-16	07-2159-16	16.0	6 1/4"	07-2160-16	07-2161-16
07-2158-18	07-2159-18	18.0	7"	07-2160-18	07-2161-18
07-2158-20	07-2159-20	20.0	8"	07-2160-20	07-2161-20
07-2158-22	07-2159-22	22.0	8 3/4"	07-2160-22	07-2161-22
07-2158-24	07-2159-24	24.0	9 1/2"	07-2160-24	07-2161-24
07-2158-26	07-2159-26	26.0	10 1/4"	07-2160-26	07-2161-26
07-2158-30	07-2159-30	30.0	12"	07-2160-30	07-2161-30

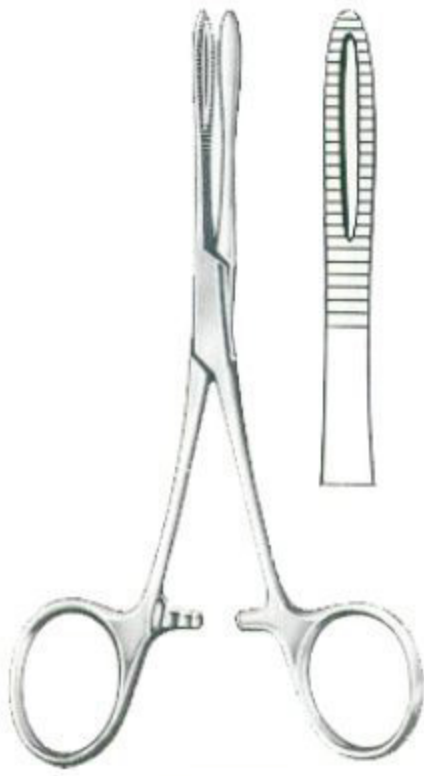
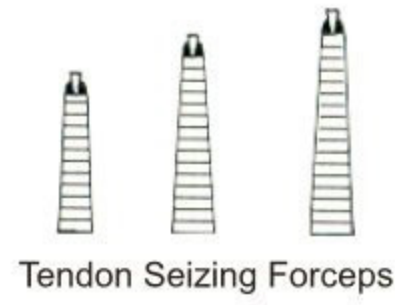

**Kronlein**  
07-2162-13  
13cm/5"



**Brand**  
07-2163-15 15cm/6"  
07-2163-19 19cm/7 1/2"  
07-2163-24 24cm/9 1/2"



**Brand**  
07-2164-15 15cm/6"  
07-2164-19 19cm/7 1/2"  
07-2164-24 24cm/9 1/2"

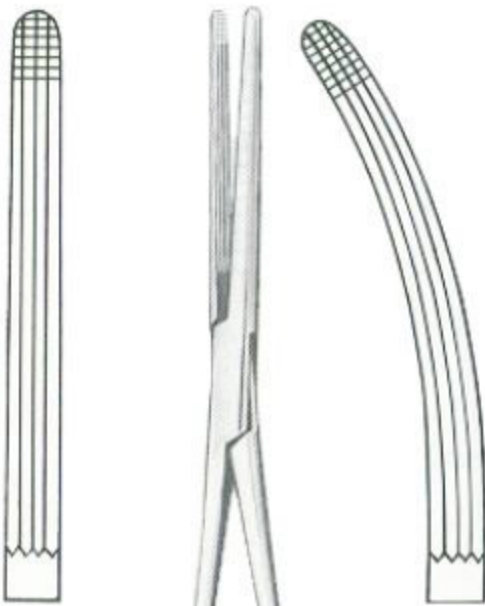

07-2165-16  
07-2165-20

07-2166-16  
07-2166-20



**Rochester-Carmalt**  
16cm/6 1/4"  
20cm/8"

Lateral Curved



07-2167-12



**Mosquito-Dandy**  
12cm/4 3/4"



07-2168-12



07-2169-14



**Dandy**  
14cm/5 1/2"

07-2170-14





**Lovelace**  
 07-2171-15  
 15.5cm/6"



**Dixon-Lovelace**  
 07-2172-16  
 16cm/6¼"



**Dixon-Lovelace**  
 07-2173-16  
 16cm/6¼"



**Bainbridge**  
 15cm/6"  
 18cm/7"



**Fuchsig**  
 07-2176-19  
 19cm/7½"



**Adson**  
18.5cm/7¼"

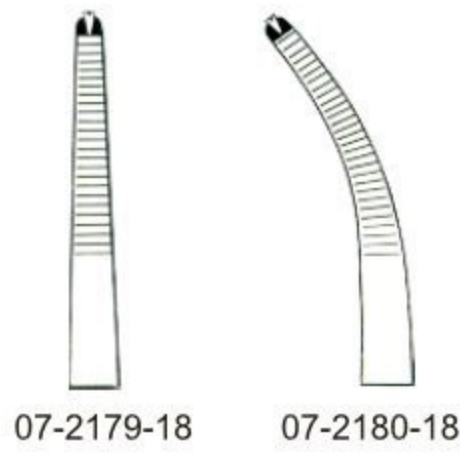
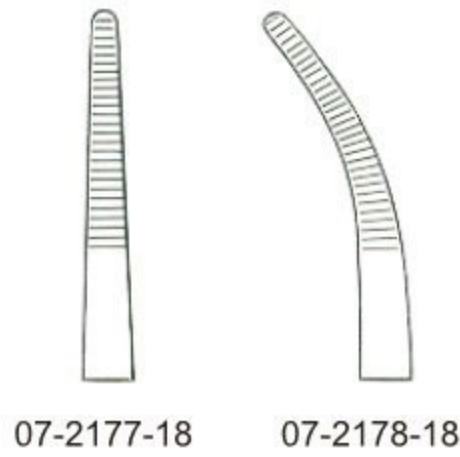

**Nissen**  
07-2181-18 18.5cm/7 ¼"  
07-2181-22 22.0cm/8 ¾"



**Baby-Adson**

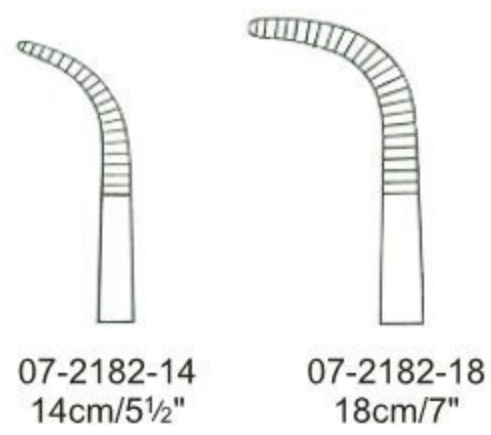

Very Fine



**Jacobson-Adson**  
18cm/7"

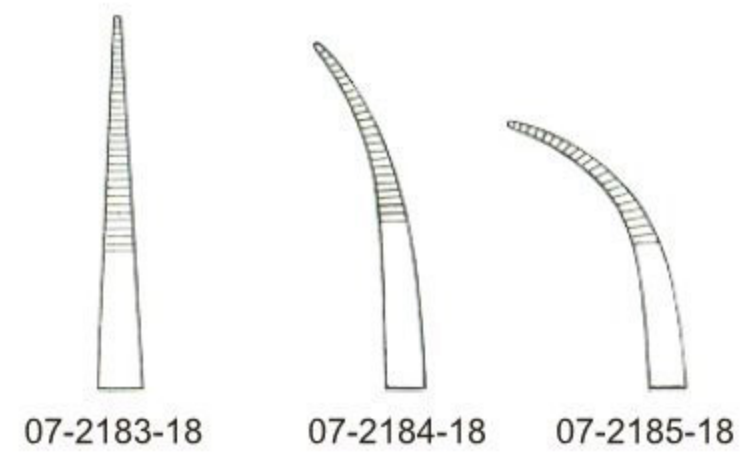

Artery Forceps ● EN  
 Arterienklemmen ● DE  
 Pinzas hemostaticas ● ES

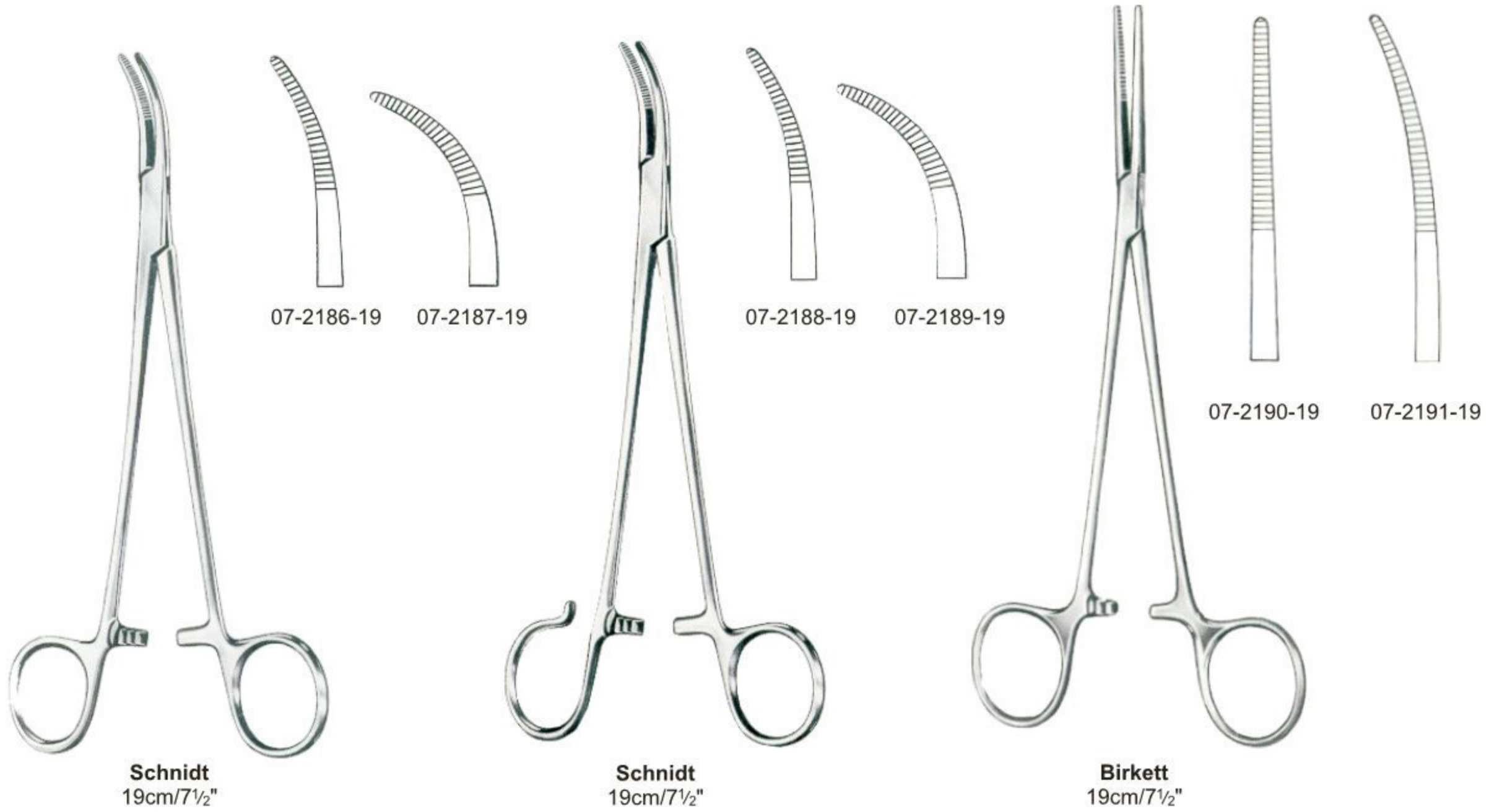

**Schnidt**  
19cm/7½"

**Schnidt**  
19cm/7½"

**Birkett**  
19cm/7½"



**Bengolea**

20cm/8"	07-2192-20	07-2193-20	07-2194-20	07-2195-20
22cm/8¾"	07-2192-22	07-2193-22	07-2194-22	07-2195-22
24cm/9½"	07-2192-24	07-2193-24	07-2194-24	07-2195-24
26cm/10¼"	07-2192-26	07-2193-26	07-2194-26	07-2195-26



**Bridge**  
27cm/10½"



07-2196-27



07-2197-27



**Roberts**  
22cm/8¾"



07-2198-22



07-2199-22



**Kelly**

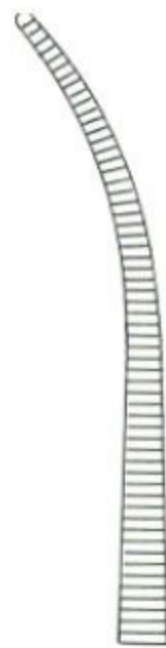

19cm/7½" 07-2200-19  
 22cm/8¾" 07-2200-22  
 24cm/9½" 07-2200-24



07-2201-19  
 07-2201-22  
 07-2201-24



07-2202-19  
 07-2202-22  
 07-2202-24

Artery Forceps ●— EN  
 Arterienklemmen ●— DE  
 Pinzas hemostaticas ●— ES



**Crafoord-Sellors**

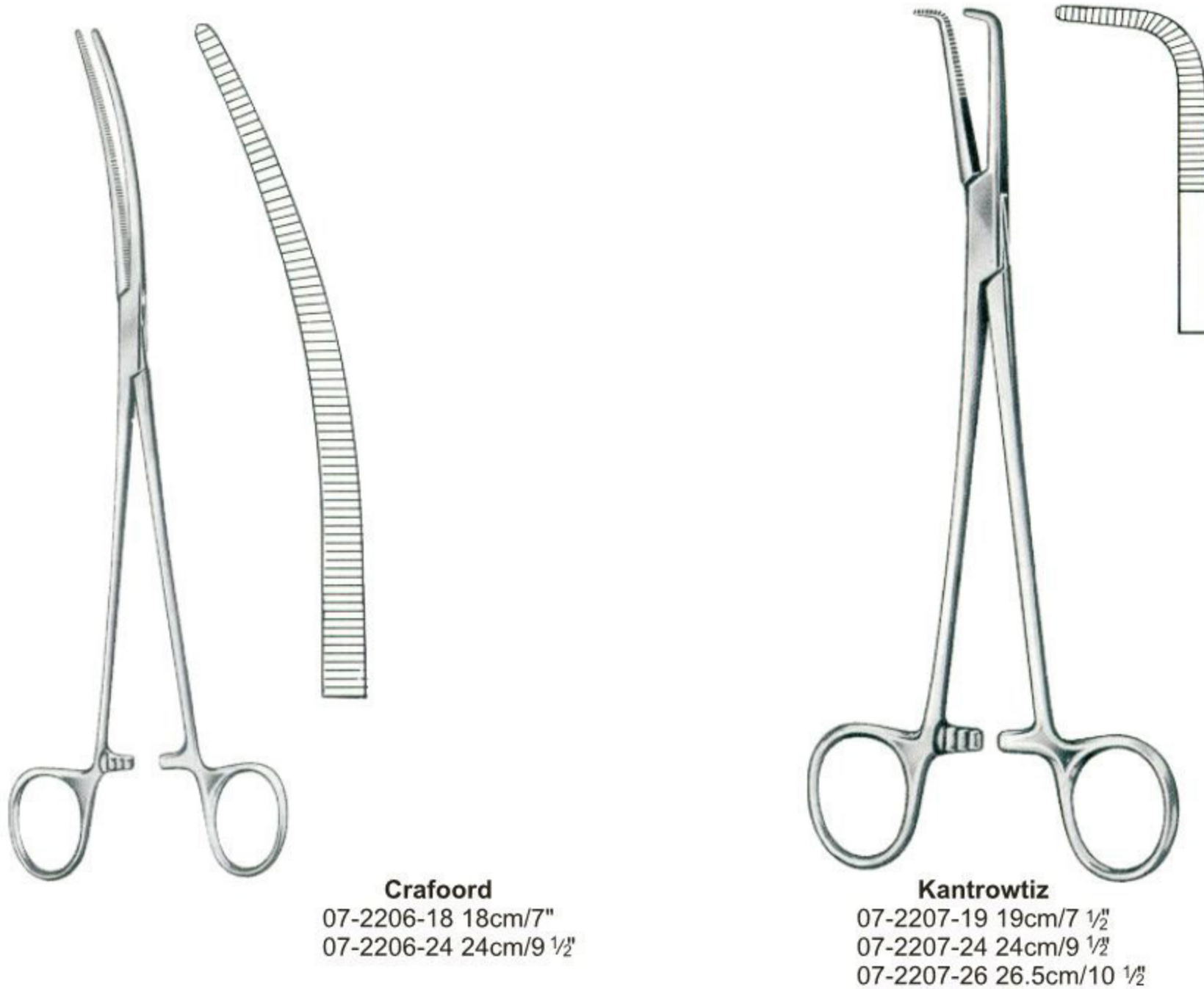



**Rumel**  
23cm/9"



07-2208-23



07-2209-23



07-2210-23



07-2211-23



07-2212-23



**Johns Hopkins**  
07-2213-20  
20cm/8"



**Zenker**  
29.5cm/11½"



07-2214-29



07-2215-29

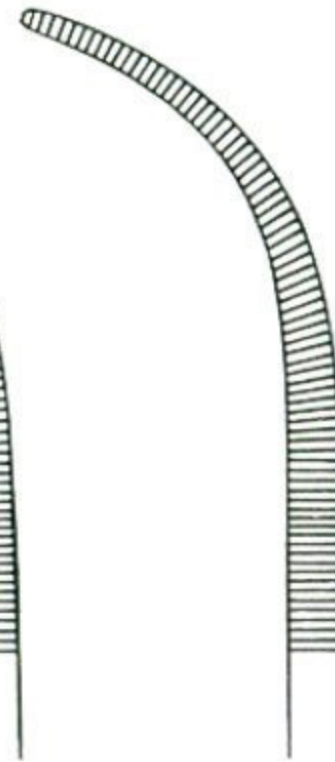

07-2216-29

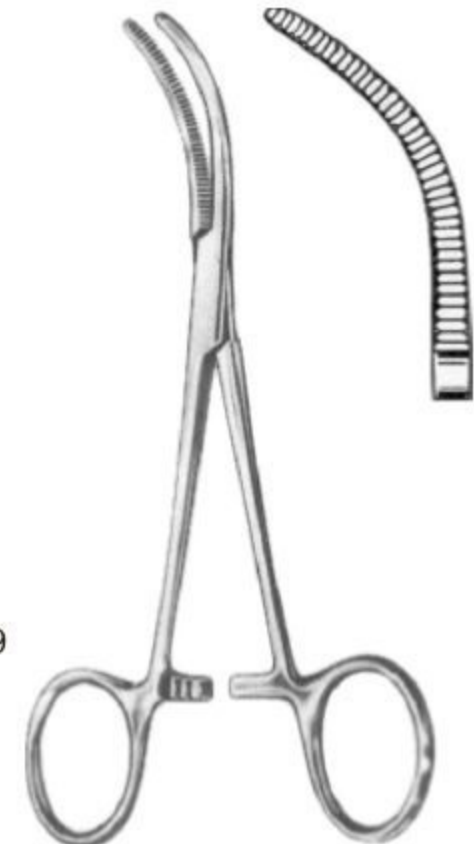

**Baby-Overholt**  
07-2217-13  
13.5cm/5¼"

Artery Forceps ●— EN  
 Arterienklemmen ●— DE  
 Pinzas hemostaticas ●— ES



Overholt-Slim



07-2218-18  
18.5cm/7¼"

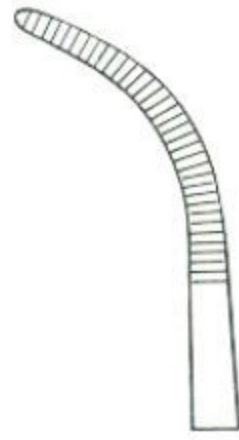

07-2219-20  
20.5cm/8"



07-2220-21  
21cm/8¼"

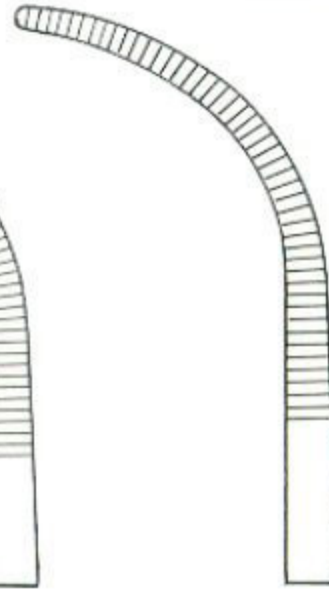

07-2221-21  
21.5cm/8½"

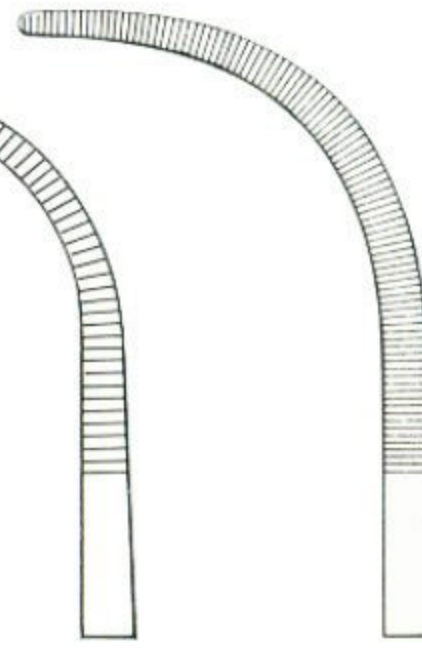

07-2222-24  
24cm/9½"



Overholt-Slim



07-2223-18  
18.5cm/7¼"



07-2224-20  
20.5cm/8"

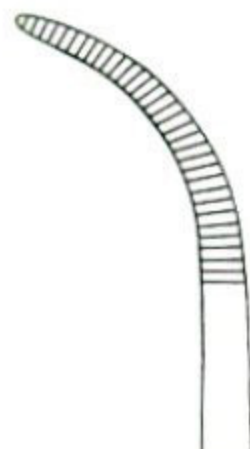

07-2225-21  
21cm/8¼"

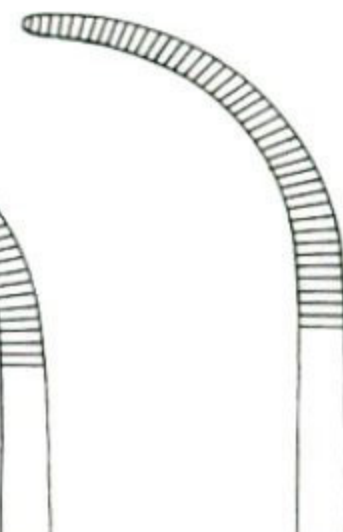

07-2226-21  
21.5cm/8¼"





**Overholt-Geissendorfer**  
 21cm/8¼"  
 27cm/10½"

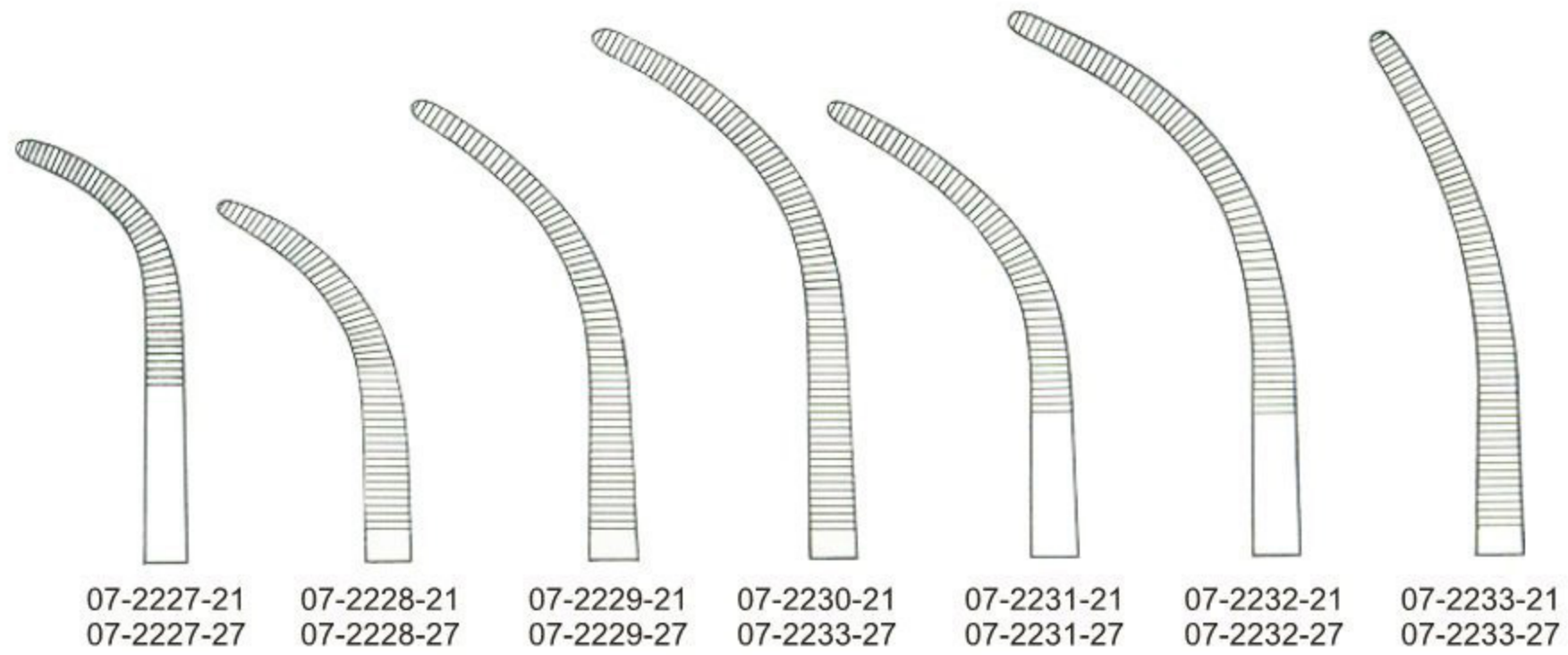

**Overholt-Mixter**  
 07-2234-21  
 21cm/8¼"



**Heiss**  
 20cm/8"

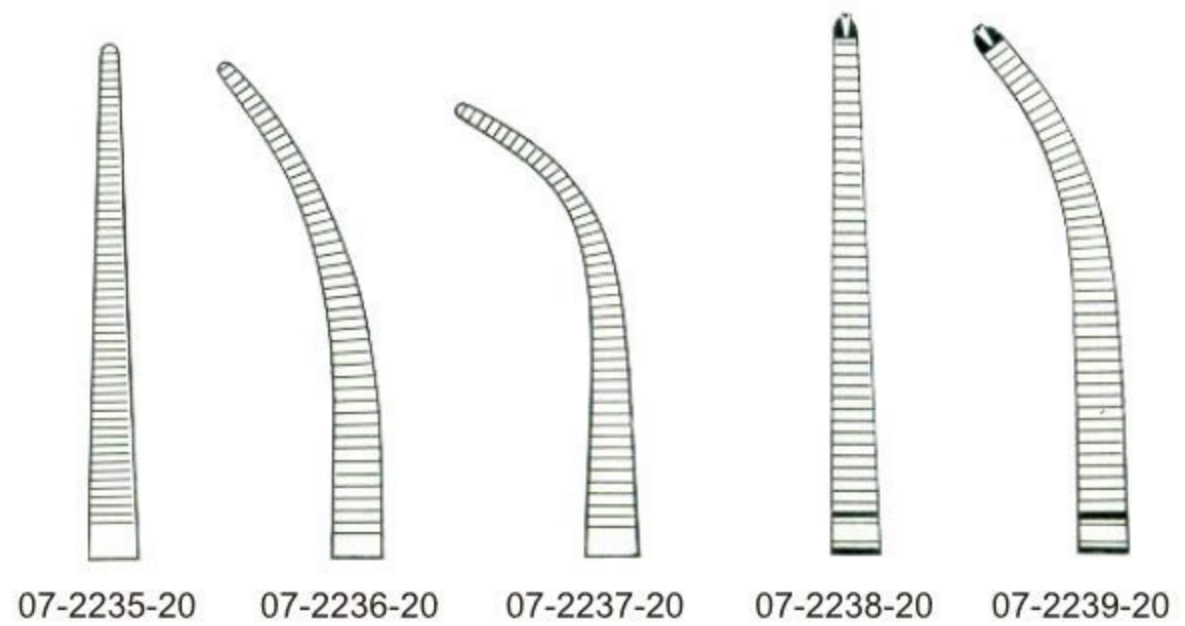





**Meeker**  
 07-2240-27  
 27 cm/10½"



**Toennis**  
 21 cm/8¼"  
 26 cm/10¼"

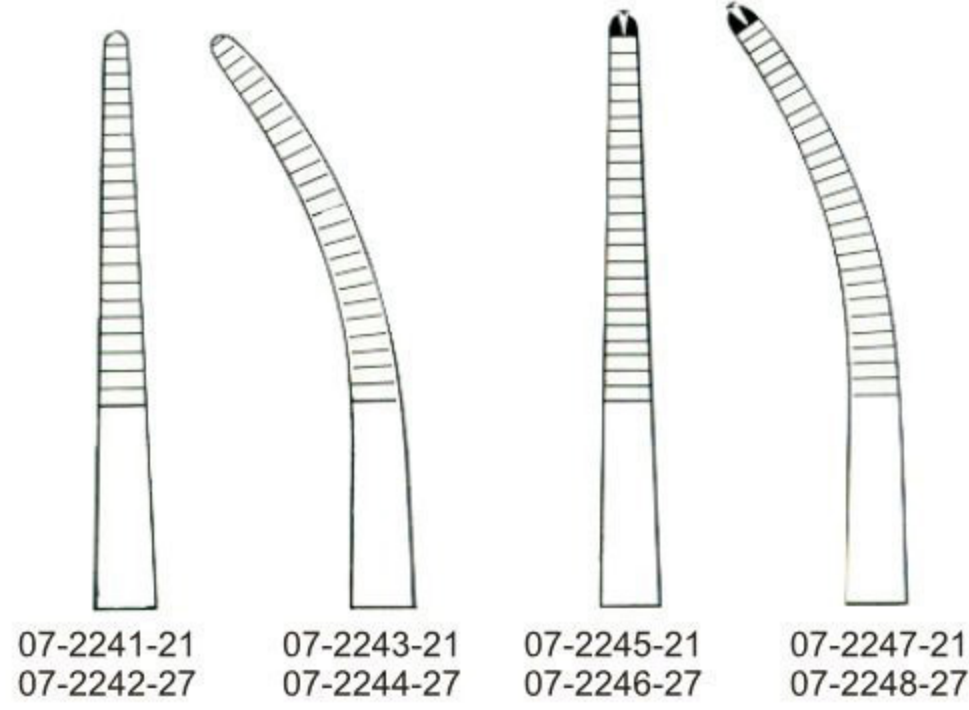

07-2241-21  
 07-2242-27  
 07-2243-21  
 07-2244-27  
 07-2245-21  
 07-2246-27  
 07-2247-21  
 07-2248-27



**Lower**  
 07-2249-18  
 18 cm/7"



**Gemini**

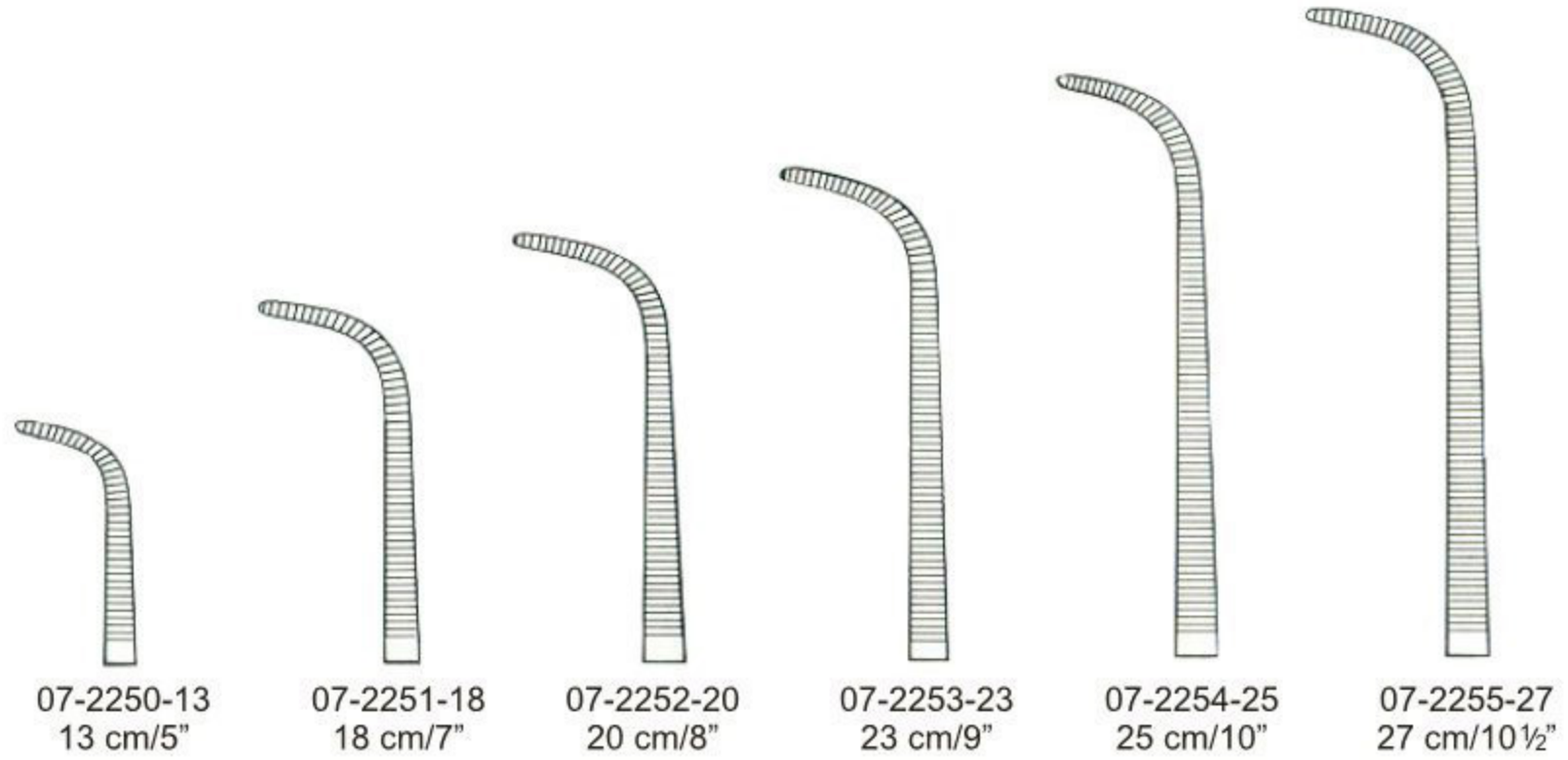

07-2250-13  
 13 cm/5"  
 07-2251-18  
 18 cm/7"  
 07-2252-20  
 20 cm/8"  
 07-2253-23  
 23 cm/9"  
 07-2254-25  
 25 cm/10"  
 07-2255-27  
 27 cm/10½"



**Mini-Gemini**

07-2256-18  
18 cm/7"



07-2256-22  
22 cm/8¾"



07-2256-25  
25 cm/10"



07-2256-28  
28 cm/11"

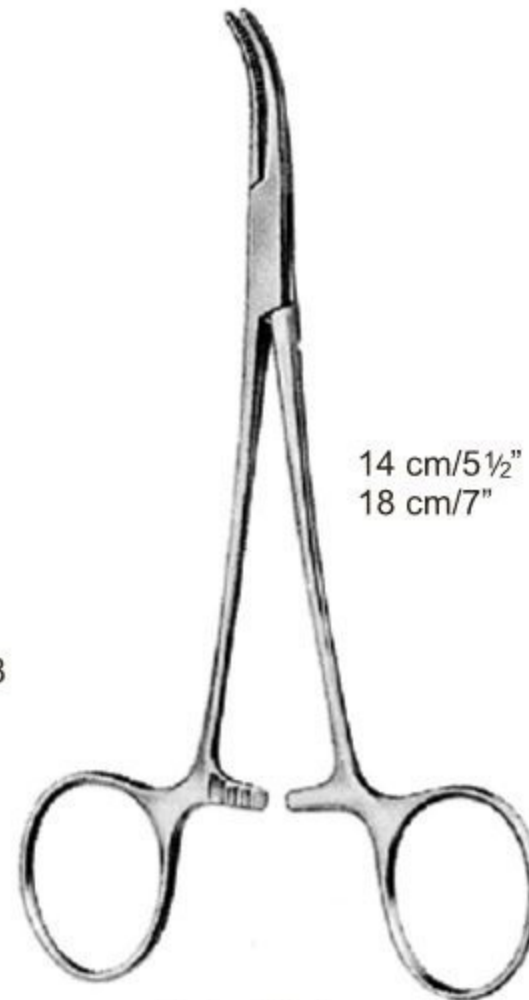

**Baby-Mixer**

14 cm/5½"  
18 cm/7"



07-2257-14  
07-2257-18



07-2258-14  
07-2258-18



**Mixer**

07-2259-15 15 cm/6"  
07-2259-19 19 cm/7½"



**Mixer-O'Shaugnessy**

07-2260-15 15.5 cm/6"  
07-2260-19 19.0 cm/7½"

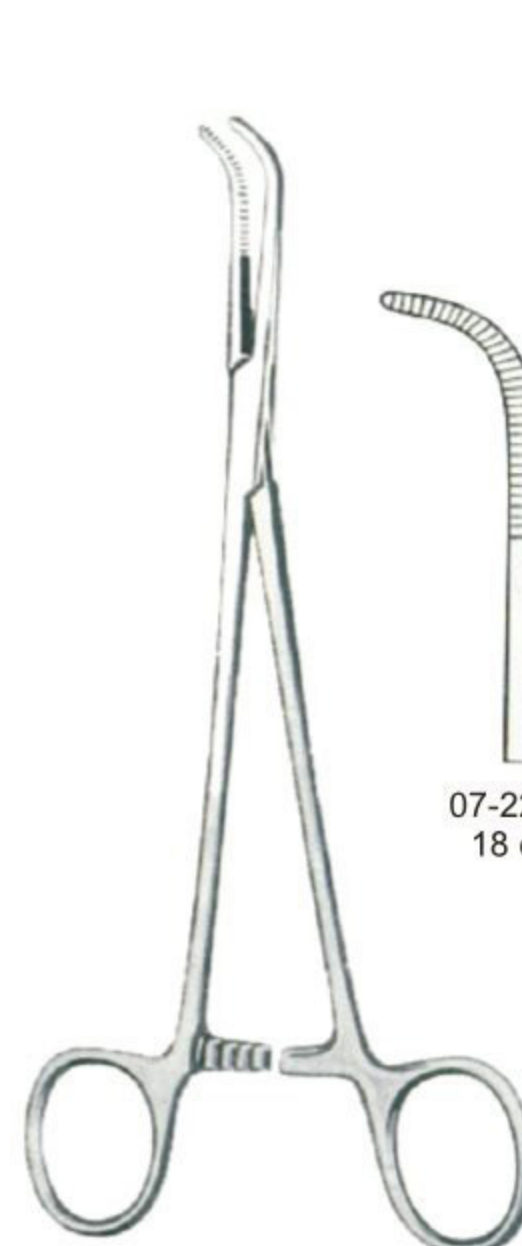

**Mixer-Slim**

07-2261-18  
18 cm/7"



07-2261-23  
23 cm/9"



Artery Forceps ● EN  
 Arterienklemmen ● DE  
 Pinzas hemostaticas ● ES



07-2262-22  
22 cm/8¾"

Mixer



07-2262-25  
25 cm/10"

07-2262-28  
28 cm/11"



Mixer  
07-2263-22  
22 cm/8¾"



Wickstroem  
07-2264-20  
20 cm/8"



Finocchietto  
07-2265-24  
24 cm/9½"



Mc Quigg-Mixer  
07-2266-22  
22 cm/8¾"



**Lawrence**  
 07-2267-27  
 27.5 cm/10¾"



**Lahey (Sweet)**

07-2268-19  
 19 cm/7½"

07-2269-23  
 23 cm/9"

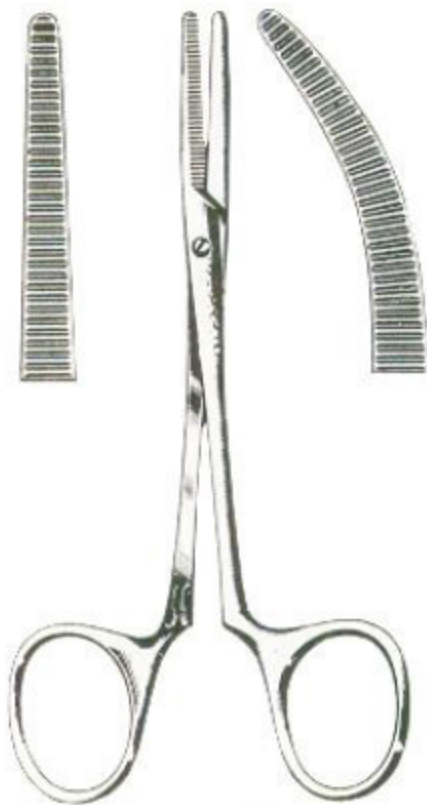

**Spencer-Wells**

- |            |          |            |
|------------|----------|------------|
| 07-2270-13 | 13 cm/5" | 07-2271-13 |
| 07-2270-15 | 15 cm/6" | 07-2271-15 |
| 07-2270-18 | 18 cm/7" | 07-2271-18 |
| 07-2270-20 | 20 cm/8" | 07-2271-20 |
| 07-2270-23 | 23 cm/9" | 07-2271-23 |



**Spencer-Wells**

- |            |            |            |
|------------|------------|------------|
| 07-2272-13 | 13 cm/5"   | 07-2273-13 |
| 07-2272-14 | 14 cm/5 ½" | 07-2273-14 |
| 07-2272-15 | 15 cm/6"   | 07-2273-15 |
| 07-2272-18 | 18 cm/7"   | 07-2273-18 |
| 07-2272-20 | 20 cm/8"   | 07-2273-20 |
| 07-2272-23 | 23 cm/9"   | 07-2273-23 |



Rogers

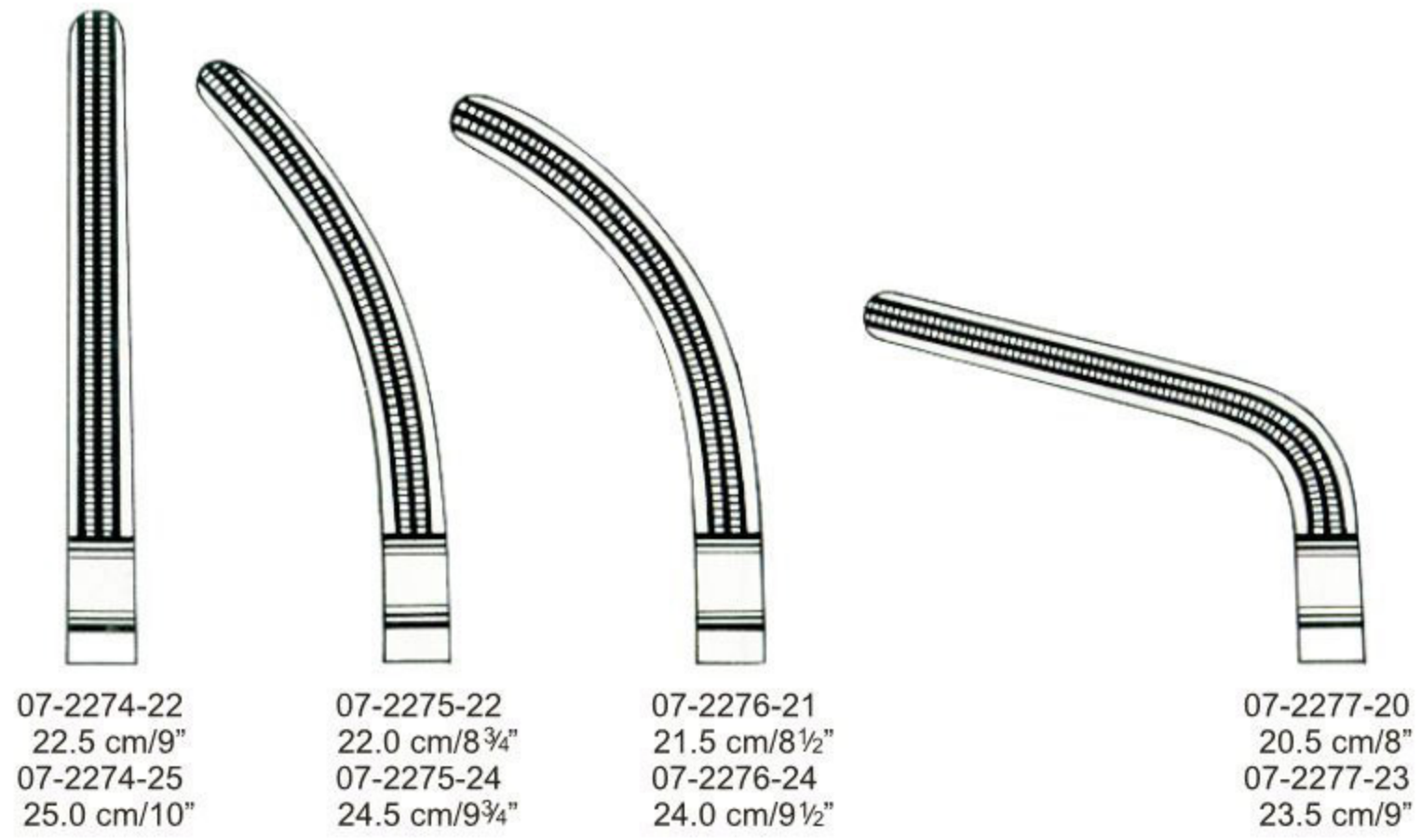

Heaney

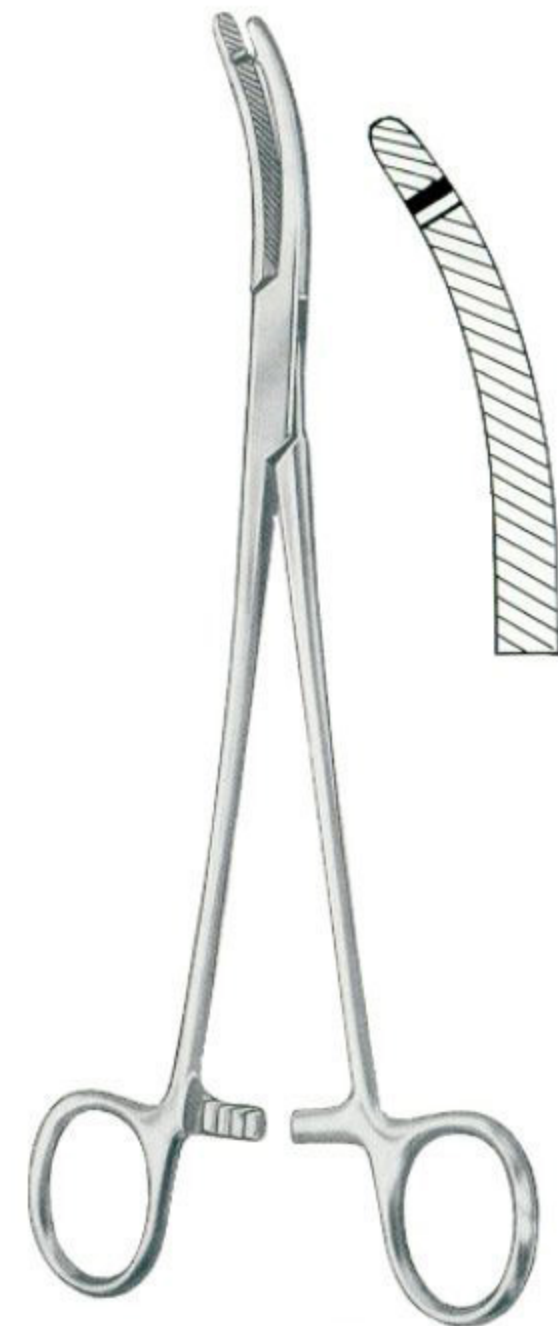
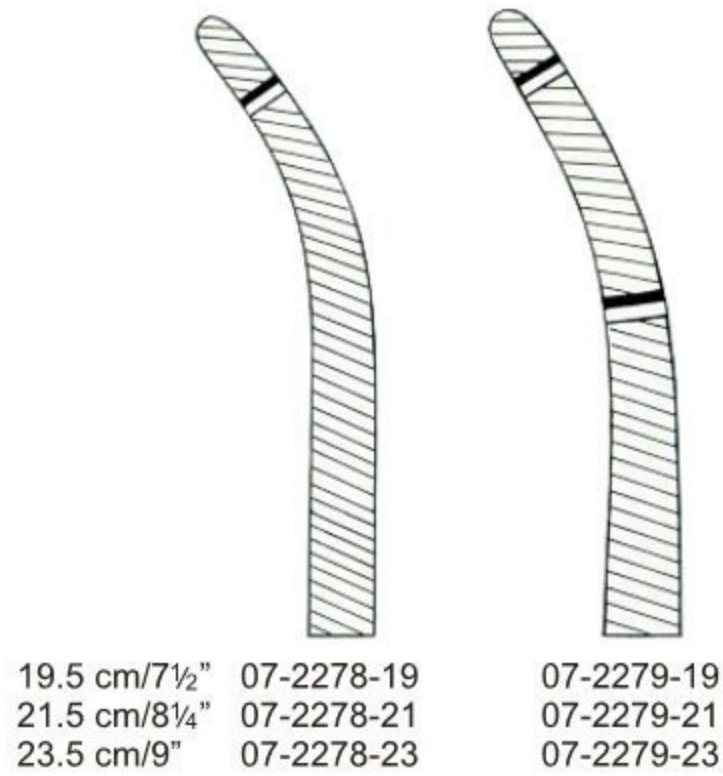

Heaney-Slim  
 07-2280-21  
 21 cm/8<sup>1</sup>/<sub>4</sub>"

EN —● Ophthalmologie. Ophthalmology, Oftalmoloia  
 DE —● Keratoplastikmesser, Stanzen Meißel  
 ES —● Keratoplastikmesser, Stanzen Meißel



**Ballentine**  
07-2281-21  
21cm/8¼"



**Heaney-Ballentine**  
07-2282-21  
21cm/8¼"



Tonsil Forceps

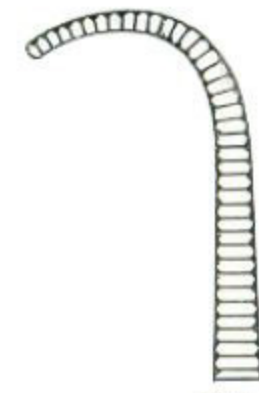

Fig. 1



Fig. 2

**Negus**  
07-2283-19 19cm/7½" 07-2284-19



**Phaneuf**  
21.5cm/8½"



07-2285-21



07-2286-21



Haemorrhoidal Clamps

	<b>Straight</b>		<b>Curved</b>
	16cm/6¼"	07-2287-16	07-2288-16
	20cm/8"	07-2287-20	07-2288-20

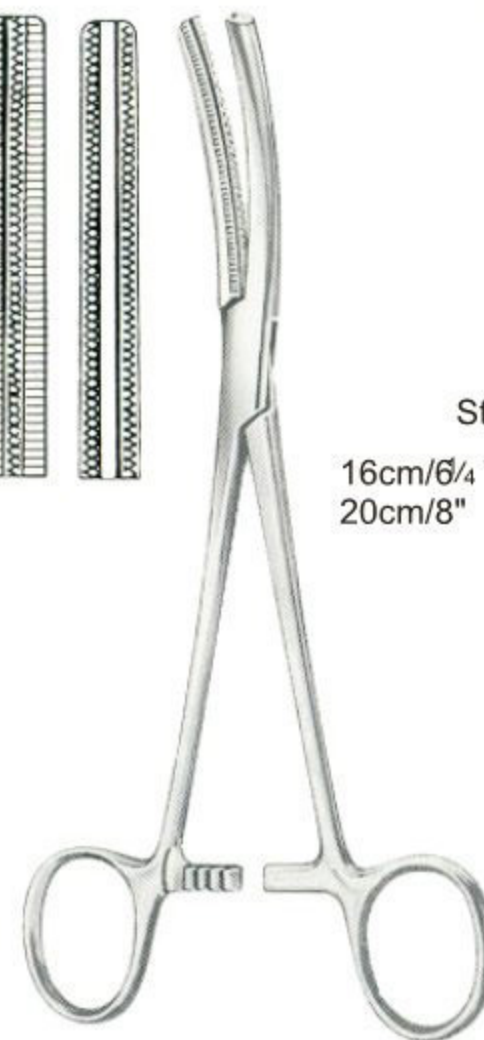

**Fergusson**

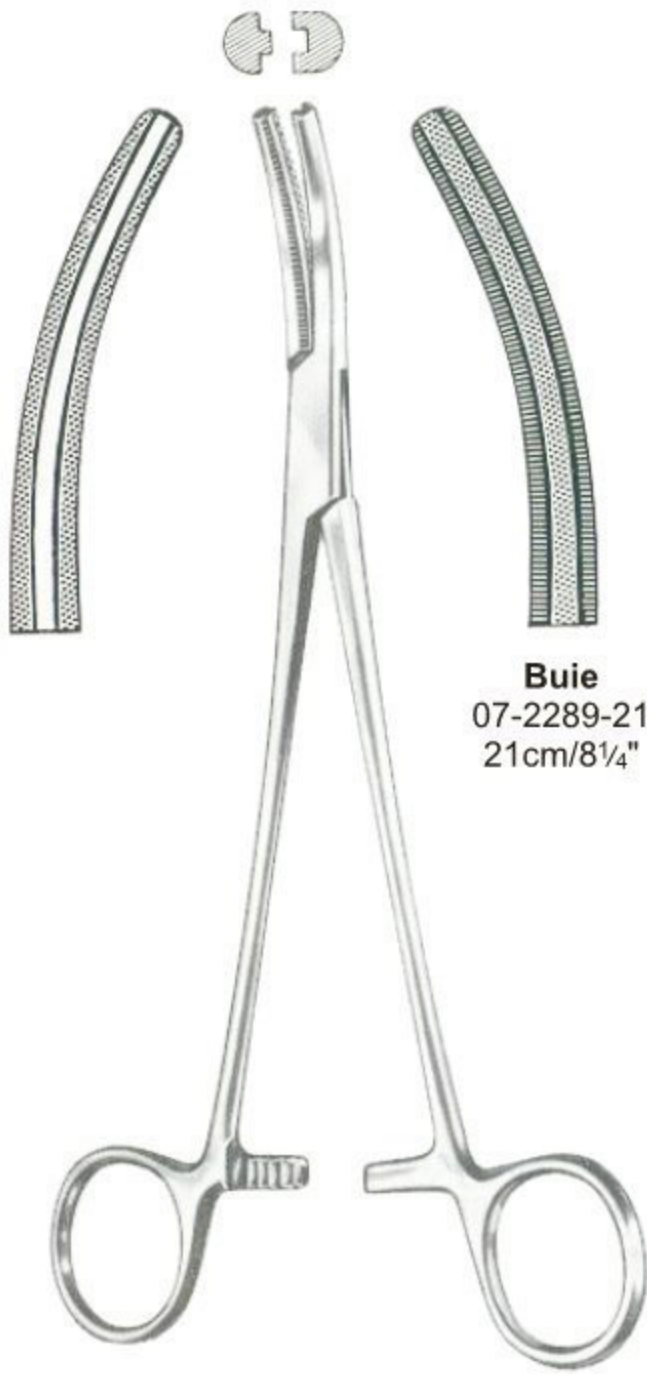

**Buie**  
 07-2289-21  
 21cm/8¼"

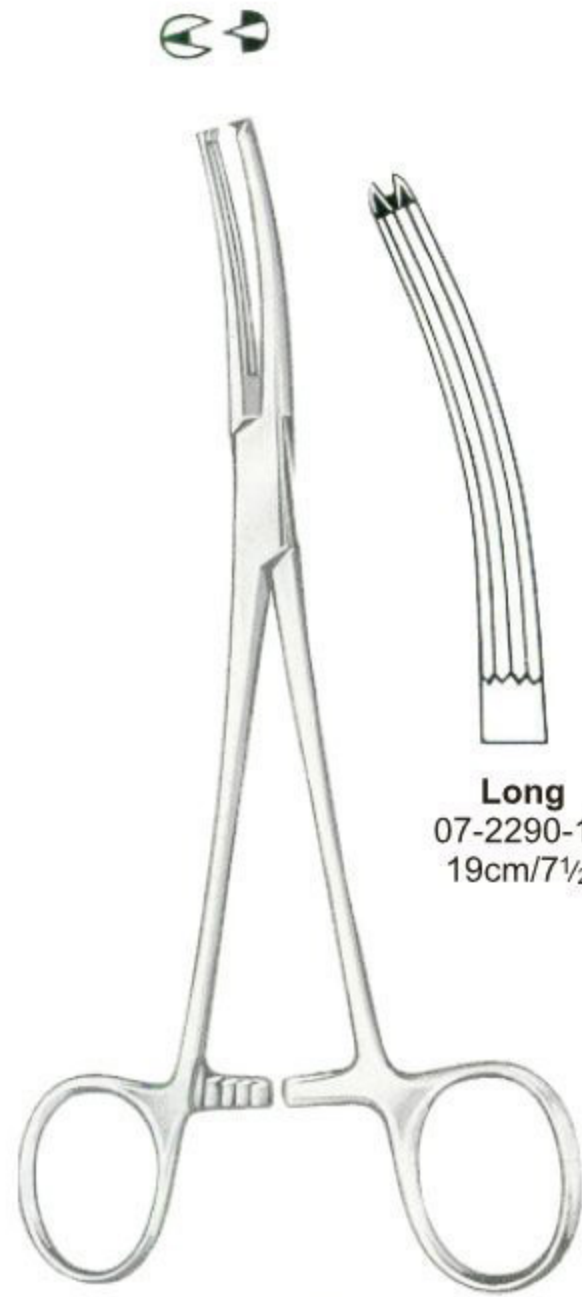

**Long**  
 07-2290-19  
 19cm/7½"



**Garland**  
 07-2291-21  
 21cm/8¼"

Gall Duct Clamps

Hysterectomy Forceps

Pressure Clamps



07-2292-23  
 23cm/9"

07-2292-24  
 24cm/9½"

**Moynihan**



07-2293-23

07-2294-23

**Hozlbach**  
 23.5cm/9¼"



**Zweifel**  
 07-2295-17  
 17.5cm/7"

Scalp Flap Forceps



**Martel**  
 07-2296-14  
 14cm/5½"



**Wertheim**  
 07-2297-25  
 25cm/10"



Extra Strong



**Wertheim-Cullen**  
 07-2298-21  
 21.5cm/8½"



**Wertheim**  
 07-2299-24  
 24cm/9½"





Artery Forceps ●— EN  
 Arterienklemmen ●— DE  
 Pinzas hemostaticas ●— ES

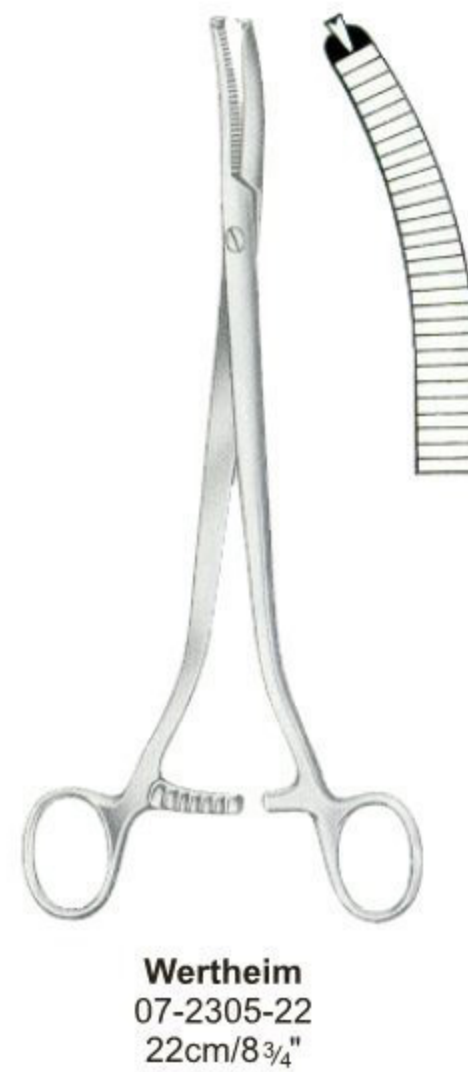
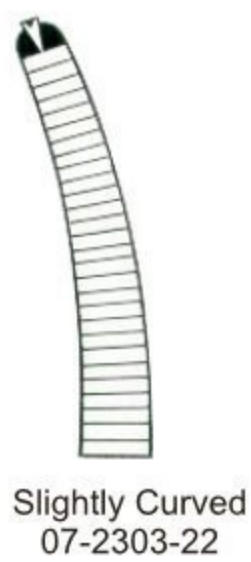
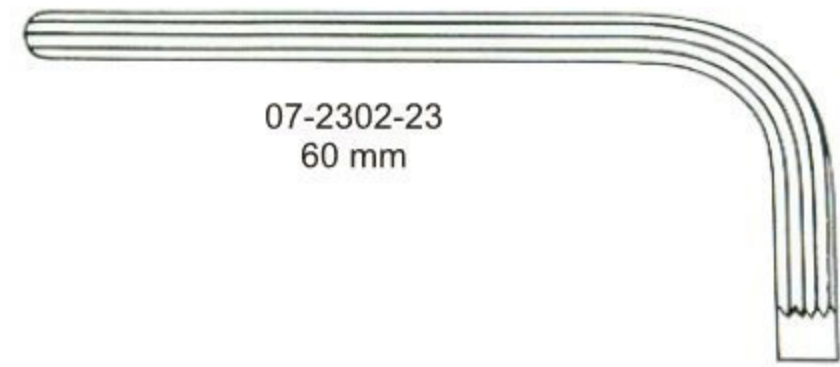
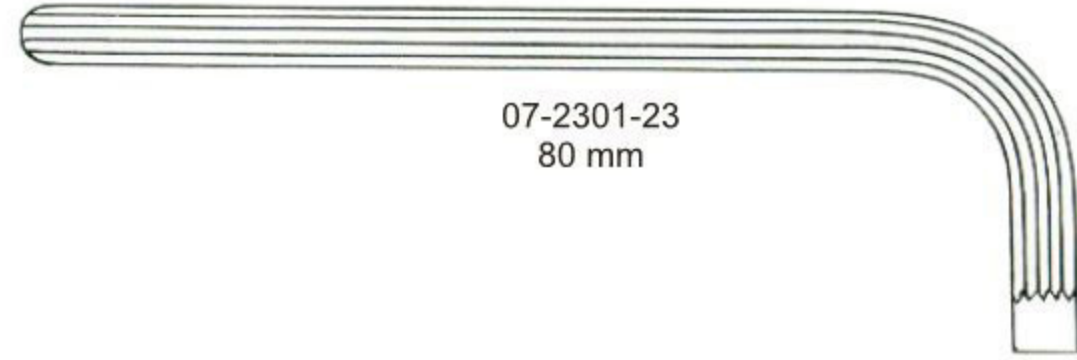
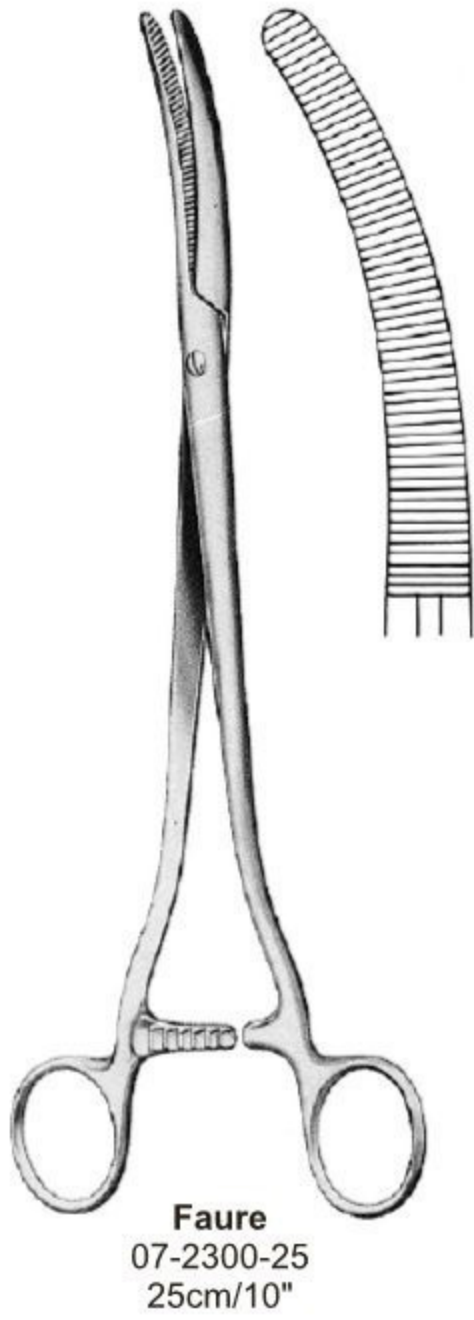



**Wertheim**  
07-2306-18  
18 cm/7"



**Baby-Mikulicz**  
07-2307-14  
14 cm/5½"



**Mikulicz**  
07-2308-18 18cm/7"  
07-2308-20 20cm/8"



**Mikulicz**  
07-2309-20  
20 cm/8"



**Mikulicz**  
07-2310-18  
18.5 cm/7 "



**Mikulicz**  
 07-2311-18  
 18 cm/7"



**Mikulicz**  
 07-2312-20 20 cm/8" 07-2313-20

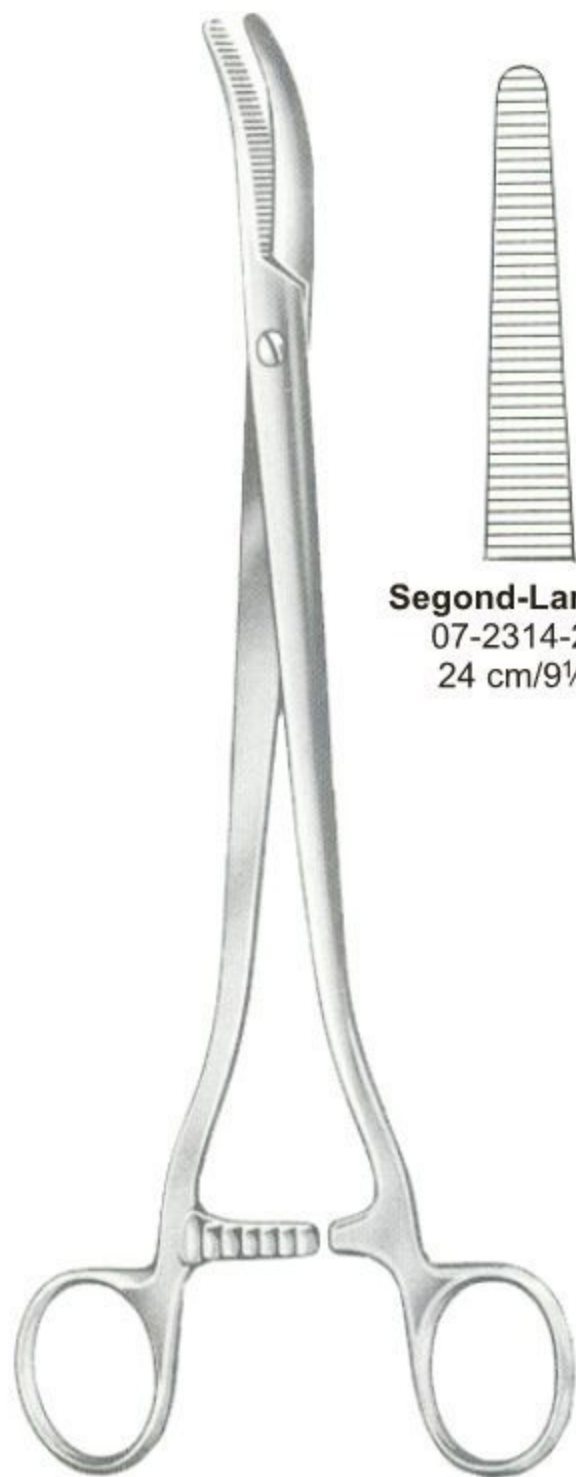

**Segond-Landau**  
 07-2314-24  
 24 cm/9½"

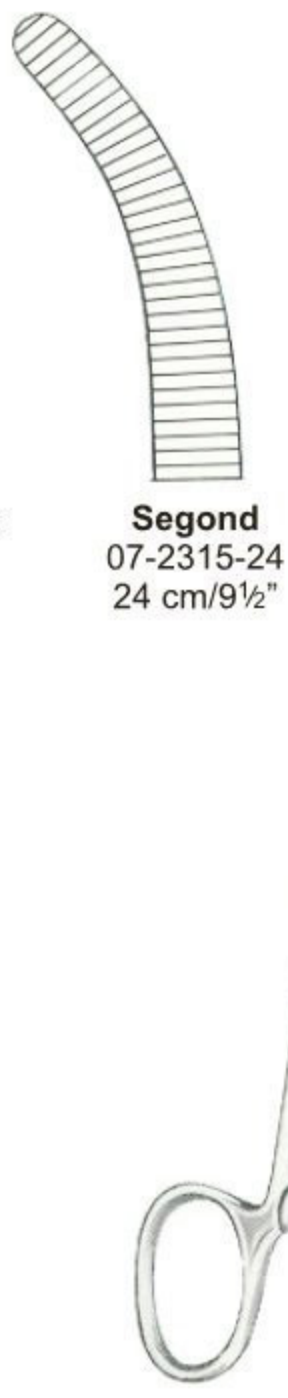

**Segond**  
 07-2315-24  
 24 cm/9½"



**Faure**  
 07-2316-20 20 cm/8" 07-2317-20



**Schindler**  
 07-2318-20  
 20 cm/8"



**Schadel**  
 07-2319-09 9 cm/3½"



**Jones**  
 07-2320-05 5 cm/2"  
 07-2320-09 9 cm/3 ½"



**Engl-Modell**  
 07-2321-09 9 cm/3½"



**Backhaus**  
 07-2322-09 9 cm/3 ½"  
 07-2322-11 11 cm/4 ½"  
 07-2322-13 13 cm/5"  
 07-2322-15 15 cm/6"

With clip for Tubing or Cable



07-2323-11 11 cm/4 ½"  
 07-2323-13 13 cm/5"



**Peers-Bertram**  
 07-2324-14 14.5 cm/5¾"



**Tohoku**  
 07-2325-10 10 cm/4"  
 07-2325-13 13 cm/5"

Artery Forceps ●— EN  
 Arterienklemmen ●— DE  
 Pinzas hemostaticas ●— ES



**Roder**  
 07-2326-13 13 cm/5"  
 07-2326-15 15 cm/6"



**Lorna**  
 07-2327-10 10 cm/4"  
 07-2327-13 13 cm/5"



**Bernhard**  
 07-2328-16 16.5 cm/6 1/2"



**Lane**  
 07-2329-20  
 20 cm/8"



**Doyen**  
 07-2330-18  
 18 cm/7"

Artery Forceps ● EN  
 Arterienklemmen ● DE  
 Pinzas hemostaticas ● ES



07-2331-14 14 cm/5 1/2"  
 07-2331-15 15 cm/6"  
 07-2331-18 18 cm/7"  
 07-2331-20 20 cm/8"



07-2332-14  
 14.5 cm/5 3/4"



07-2333-16 16.5 cm/6 1/2"  
 07-2333-18 18.0 cm/7"



07-2334-15 15 cm/6"  
 07-2334-18 18 cm/7"  
 07-2334-20 20 cm/8"



**Mohr**  
 07-2335-50 50 mm  
 07-2335-60 60 mm  
 07-2335-70 70 mm  
 07-2335-80 80 mm

Sizes  
 mm  
 13  
 17  
 20  
 25  
 30

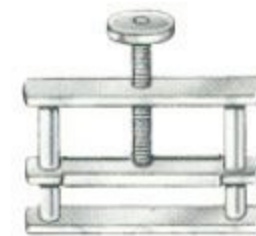

**Hoffmann**  
 07-2336-13  
 07-2336-17  
 07-2336-20  
 07-2336-25  
 07-2336-30

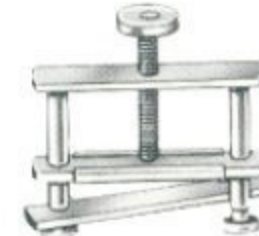

**Hoffmann**  
 07-2337-13  
 07-2337-17  
 07-2337-20  
 07-2337-25  
 07-2337-30