



- EN** Ophthalmology
- DE** Ophthalmologie
- ES** Oftalmología

Page 389 to 419



EN —● Eye Speculas
 DE —● Lidsperrer
 ES —● Espéculos ojo



Weiss
 Children 16-4501-07
 7 cm/2¾"
 Adults 16-4502-09
 9 cm/3½"



Weiss
 Children 16-4503-07
 7 cm/2¾"
 Adults 16-4504-09
 9 cm/3½"



Park
 16-4505-08
 8 cm/3¼"



Park-Guyton
 16-4506-08
 8 cm/3¼"



Park-Maumenee
 16-4507-08
 8 cm/3¼"



Barraquer (Colibri)
 Children 16-4508-03
 3 cm/1¼"
 Adults 16-4509-04
 4 cm/1½"



Barraquer
 16-4510-04
 4 cm/1½"



Bowman
 16-4511-07
 7 cm/2¾"



Sauer
 16-4512-03
 3 cm/1¼"



Goldstein
 16-4513-03
 3 cm/1¼"



Pley
 16-4514-06
 6 cm/2¼"

For left eye



Arruga
 16-4515-07
 7 cm/2¾"

For right eye



Arruga
 16-4516-07
 7 cm/2¾"

Eye Speculas ●— EN
 Lidsperrer ●— DE
 Espéculos ojo ●— ES



Mellinger-Axenfeld
 16-4517-07
 7 cm/2 3/4"



Mellinger-Axenfeld
 16-4518-07
 7 cm/2 3/4"



Children
 16-4519-05
 5 cm/2 3/4"
Mellinger
 Adults
 16-4520-07
 7 cm/2 3/4"



Children
 16-4521-05
 5 cm/2"
Mellinger Beard
 Adults
 16-4522-07
 7 cm/2 3/4"



Knapp Clark
 16-4523-08
 8 cm/3 1/4"



Children
 16-4524-06
 6 cm/2 1/2"
Graefe
 Adults
 16-4525-09
 9 cm/3 1/2"



Lancaster
 16-4526-08
 8 cm/3 1/4"



Children
 16-4527-07
 7 cm/2 3/4"
Williams
 Adults
 16-4528-08
 8 cm/3 1/4"



Lister-Burch
 16-4529-08
 8 cm/3 1/4"



Weiss
 16-4530-08
 8 cm/3 1/4"



Murdock
 16-4531-05
 5 cm/2"



Mueller
 16-4532-07
 7 cm/2 3/4"



Critchett
 16-4533-06
 6 cm/2 1/2"



Castroviejo
 16-4534-08
 8 cm/3 1/4"



Schepens
 16-4535-13
 13 cm/5"



Desmarres
 16-4536-13
 13 cm/5"



8 mm

Conway
 16-4537-13
 13 cm/5"



Desmarres
 13 cm/5"



16-4538-12
 12 mm



16-4538-14
 14 mm



16-4538-16
 16 mm



16-4538-18
 18 mm

Lid plate



Jaeger
 16-4539-11
 11 cm/4½"

Eye Knives ●— EN
 Eye Messer ●— DE
 Cuchillos ojo ●— ES

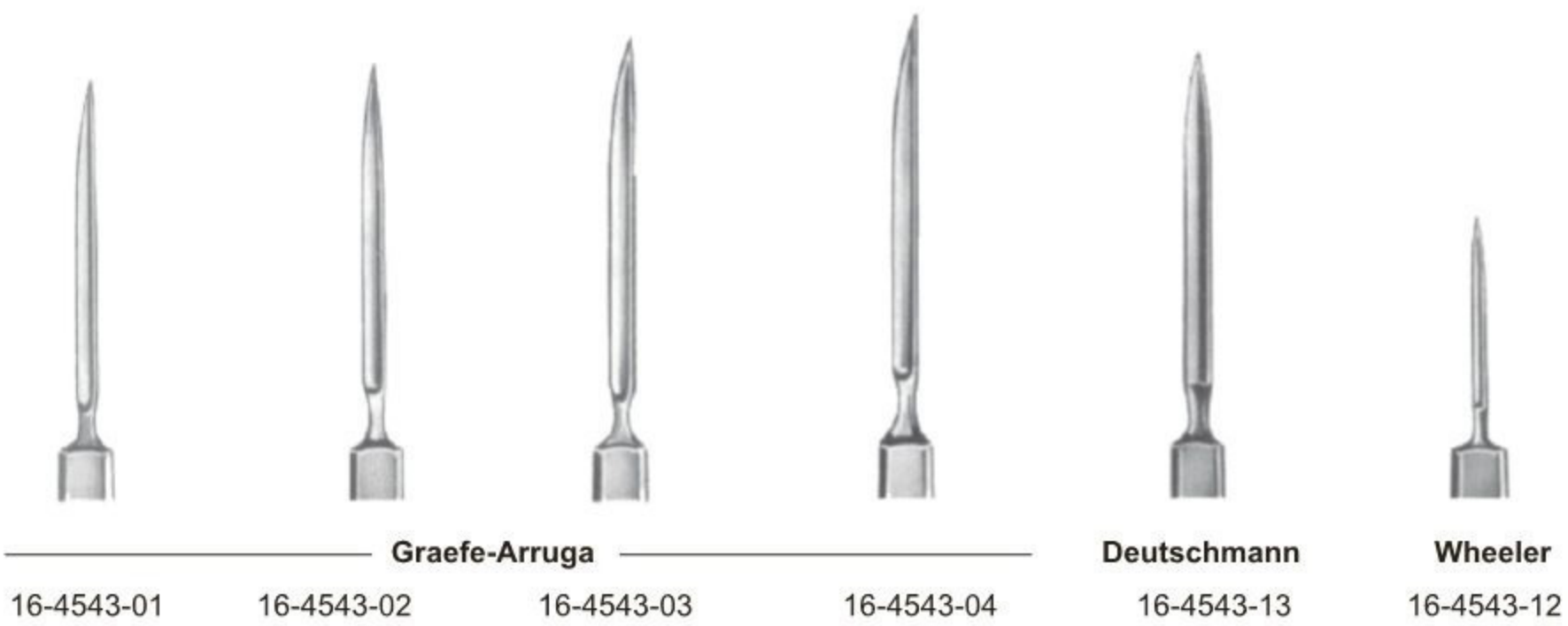
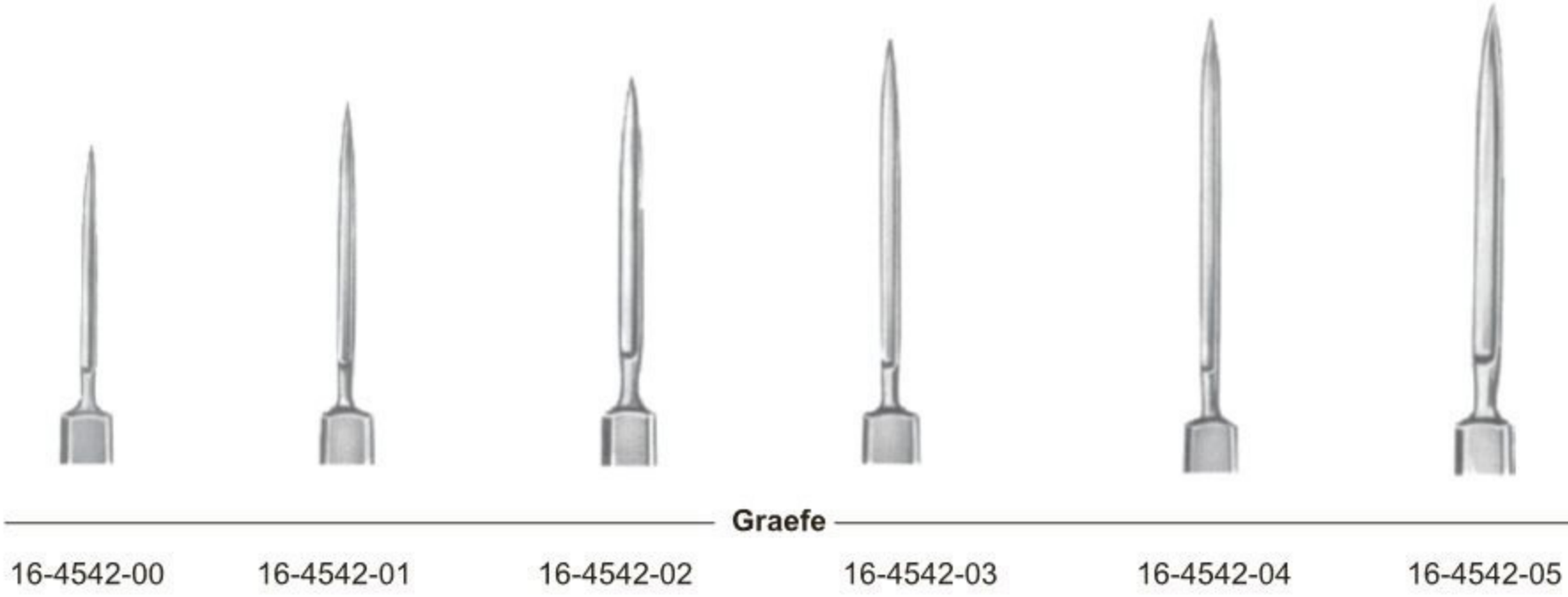
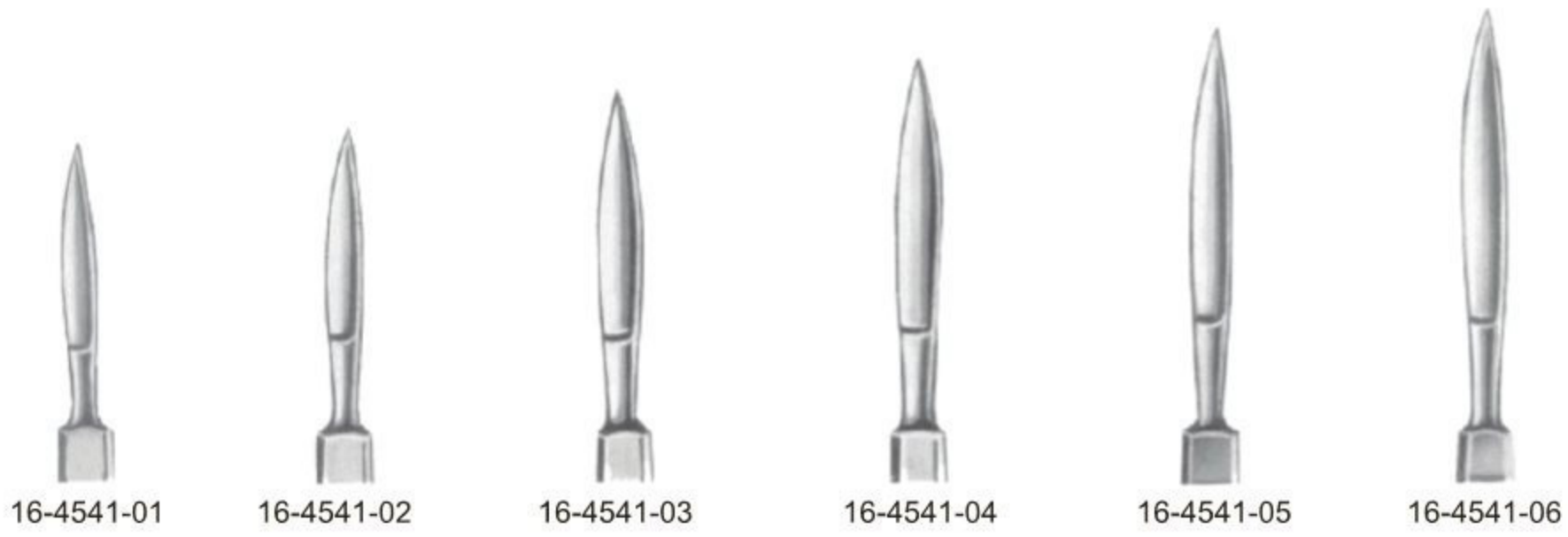



Jaeger
16-4544-01



16-4544-02



16-4544-03



16-4544-04



16-4545-01



16-4545-02



16-4545-03



16-4545-04



16-4546-01



16-4546-02



16-4546-03



16-4546-04



16-4547-01



16-4547-02



16-4547-03



16-4547-04

Jaeger-Grieshaber



16-4548-01



16-4548-02



16-4548-03



16-4548-04

Jaeger-Grieshaber

Keratomes, Various Eye Knives ●— EN
 Keratomes, Verschiedene Eye Messer ●— DE
 Keratomes, varios cuchillos de ojos ●— ES

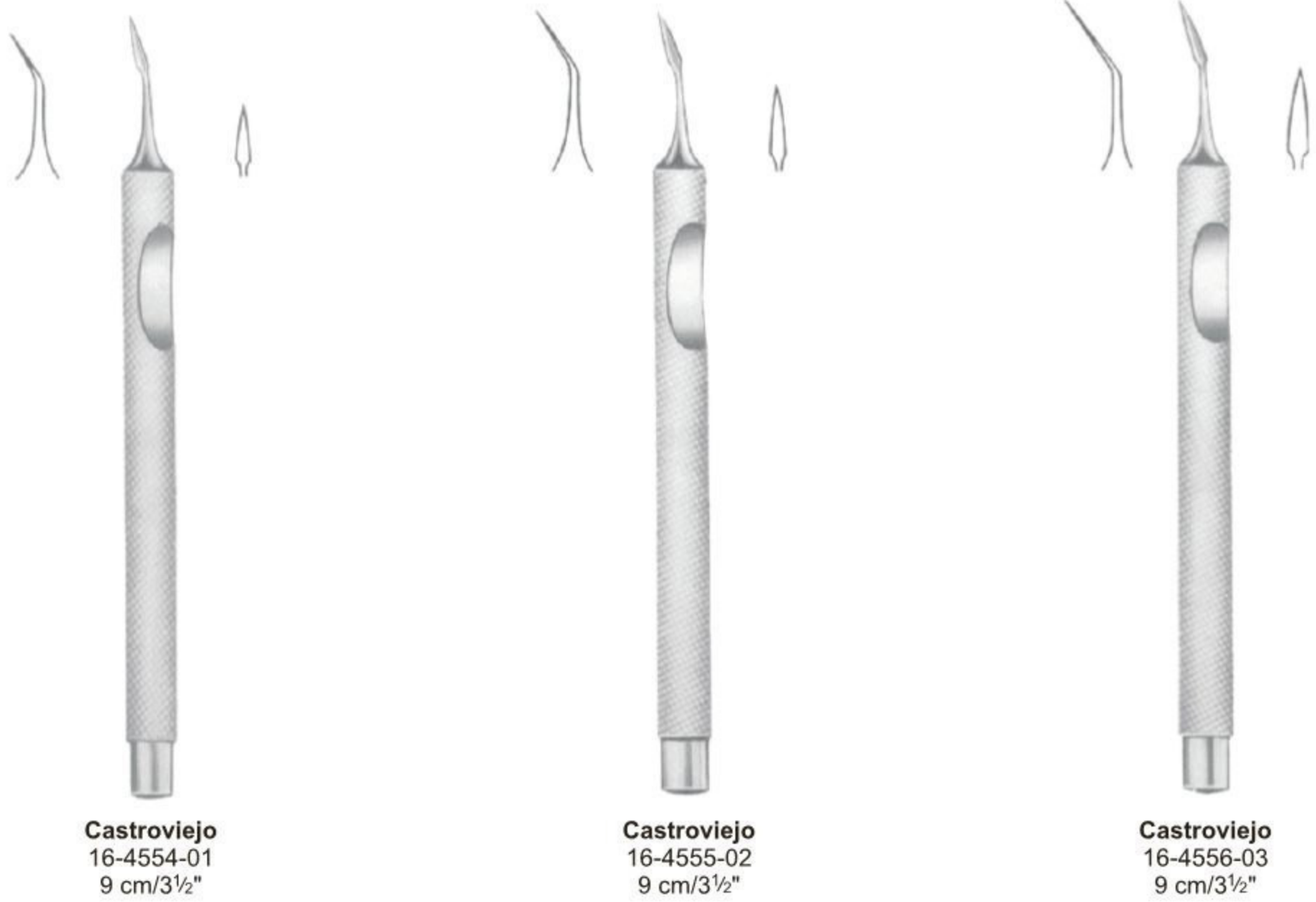

- EN —● Various Eye Knives
- DE —● Verschiedene Eye Messer
- ES —● Varios cuchillos de ojos



Mod. Hamburg
16-4557-12



Graefe
16-4558-13



16-4559-01



Weber
16-4559-02



16-4559-03



Bowman
16-4560-04
0.4 mm



Bowman
16-4560-05
0.5 mm



Bowman
16-4560-06
0.6 mm



Bowman
16-4560-07
0.7 mm



Bowman
16-4560-08
0.8 mm



Left **Bowman** Right
16-4561-01 16-4561-02



16-4562-01



Knapp
16-4562-02



16-4562-03



16-4563-05
5 mm



Ziegler
16-4563-06
6 mm



16-4563-07
7 mm

Various Eye Knives ● EN
 Verschiedene Eye Messer ● DE
 Varios cuchillos de ojos ● ES



Dean
16-4564-13



Zigler
16-4565-11
3½ mm



Sato
16-4566-12



Sichel
16-4567-13



Graefe
16-4568-13



Graefe
16-4569-13



16-4570-01



Kuhnt
16-4571-02



16-4572-03



16-4573-04



Paton
16-4574-12



Elsching
16-4575-13



Took
16-4576-12



16-4577-01



Desmarres
16-4578-02



16-4579-03



Gill
16-4580-12



Hooks, Protectors and Spatulas ●— EN
 Hooks, Protektoren und Spatel ●— DE
 Ganchos, protectores y espátulas ●— ES



Axenfeld

Sharp
16-4590-14

Blunt
16-4591-14



Axenfeld

Sharp
16-4592-14

Blunt
16-4593-14



Paul
16-4594-12



Sautter
16-4595-01



Sautter
16-4596-02



Sautter
16-4597-03



Arruga
16-4598-13



Stevens
16-4599-14



Stevens
16-4600-12



Graefe
16-4601-01



Graefe
16-4602-02



Graefe
16-4603-03



Wecker
16-4604-13



Wecker
16-4605-13



Stock
16-4606-13



Stock
16-4607-13



Culler
16-4608-13



Suker
16-4609-14

- EN —● Enucleation Scoops and Chalazion Curettes
- DE —● Enucleation Schaufeln und Chalazion Küretten
- ES —● Enucleación Scoops y curetas Chalazión

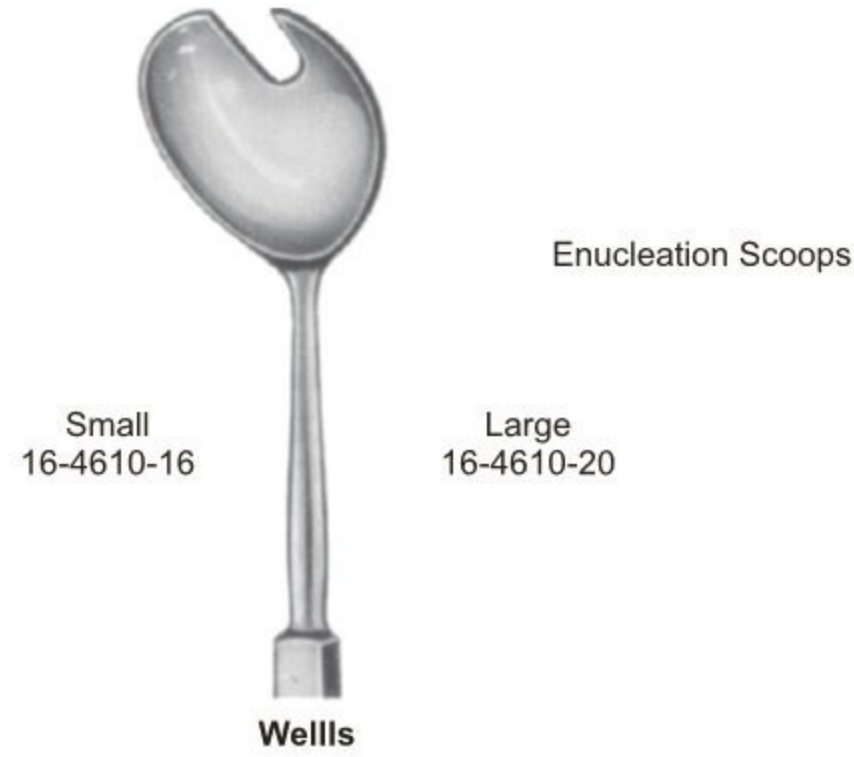

Chalazion Curettes



- Exenteration Scoops and Chalazion Curettes Lachrymal Sac Dissectors ●— EN
- Exenteration Schaufeln und Chalazion Küretten Tränensack Dissektoren ●— DE
- Exenteración Scoops y Chalazión Curetas saco lagrimal Disectores ●— ES

Exenteration Scoops

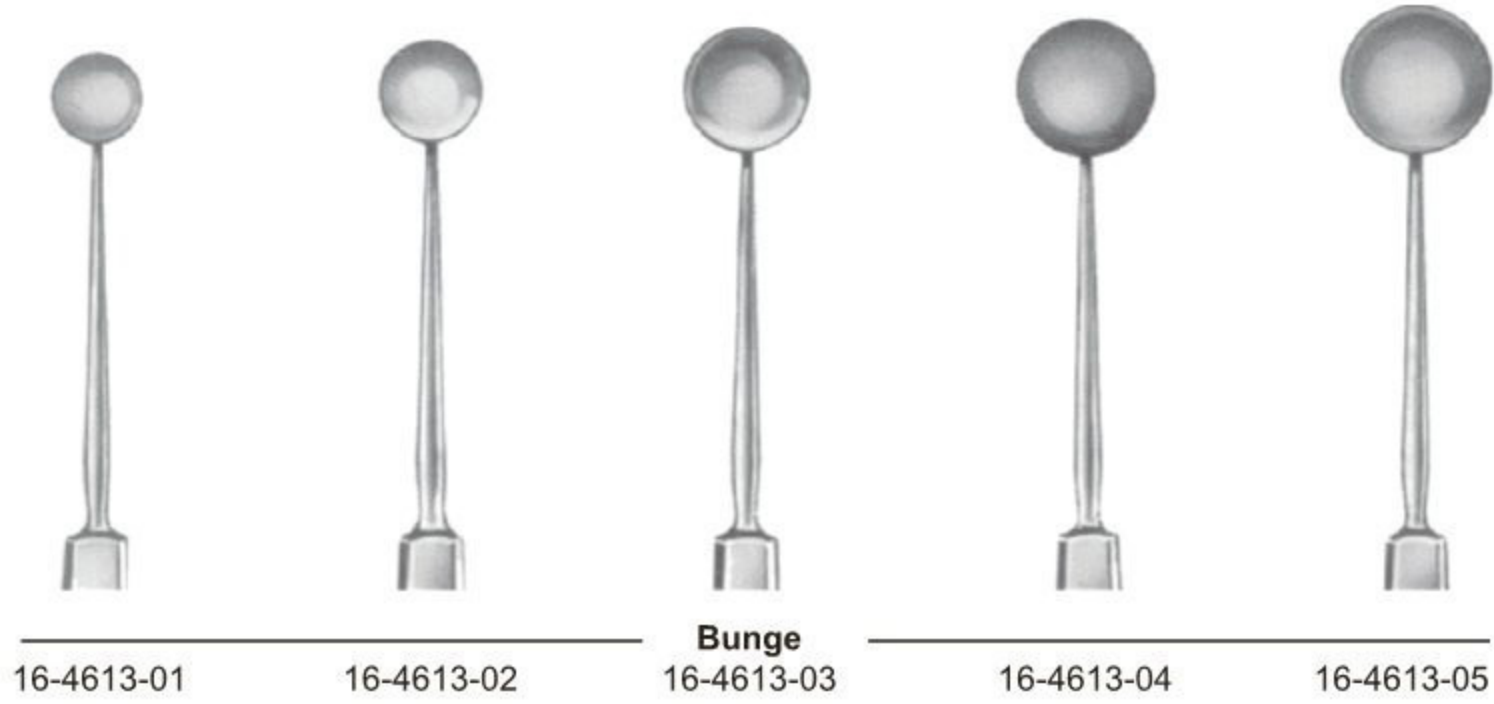

Chalazion Curette, Double

Axenfeld
16-4614-13
13 cm/5"



Lachrymal Sac Dissector

Lang
16-4615-13
13 cm/5"

EN —● Eye Cannulas
 DE —● Augenkanülen
 ES —● Cánulas ojo

Irrigating Cannulas

Straight



Binkhorst
 16-4616-01
 22 gauge

Right



Binkhorst
 16-4617-02
 22 gauge

Left



Binkhorst
 16-4618-03
 22 gauge



Bonn
 16-4619-04
 20 gauge



Bonn
 16-4620-05
 19 gauge

Probe Point



Hamburg
 16-4621-06
 23 gauge



Simcoe
 16-4622-01
 23 gauge

Irrigation/Aspiration Cannulas



stotome Cannulas

Gills-Welsh
 16-4623-02
 25/23 gauge

Lens Manipulation Cannulas



Knolle-Kelmann
 16-4624-01
 22 gauge



Nevyas
 16-4625-02
 22 gauge



Kratz
 16-4626-03
 22 gauge



Freeman
 16-4627-01
 27 gauge

Eye Cannulas ●— EN
 Augenkanülen ●— DE
 Cánulas ojo ●— ES



Irrigating Vectis Cannulas



Cortex Aspiration Cannulas

Capsule Polishing Cannulas



- EN —● Calipers, Markers, Punches Chisels, Marking instruments and Lachrymal Dilators
- DE —● Messschieber, Marker, Punches Meißel, Kennzeichnung Instrumente und Lachrymal Dilatoren
- ES —● Pinzas, marcadores, cinceles Punzones, los instrumentos de marcado y Dilatadores lagrimales



Castroviejo
16-4636-15



Castroviejo
16-4637-20
20 mm



Holth
16-4638-01



Haitz
16-4639-02



West
16-4640-16
16 cm/6 1/4"



West
16-4641-16
16 cm/6 1/4"



Connin-Amsler
16-4642-13
13 cm/5"



Wilder
16-4643-01



Wilder
16-4644-02



Wilder
16-4645-03

Lachrymal Dilators and Probes ●— EN
 Lachrymal Dilatoren und Probes ●— DE
 Dilataores lagrimales y sondas ●— ES

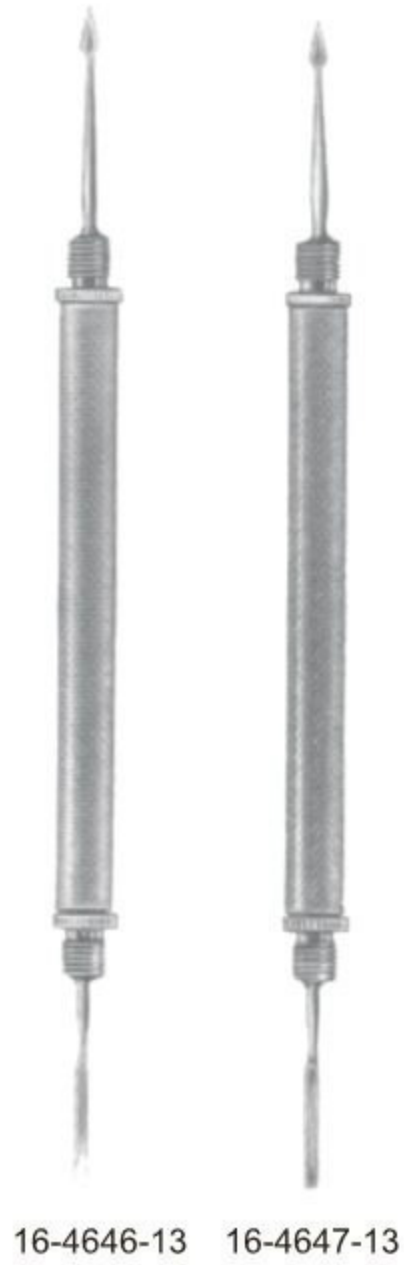

Nedde Only
16-4648-01

Chisel Only
16-4648-02

Gouge Only
16-4648-03



Instrumentation for D. B. Kirby Operations



16-4650-10



Teeth
16-4651-10 1:2 Teeth
16-4652-10 2:3 Teeth



16-4653-10
1 : 2



Kirby
16-4654-10
10 cm/4"



Kirby
16-4655-10
10 cm/4"



16-4656-10



16-4657-10



Tuebingen
16-4658-10
10 cm/4"



16-4659-08
8.5 cm/3 1/2"



Paufigue
16-4660-10
10 cm/4"



Barraquer
16-4661-10
10.5 cm/4 1/4"



McPherson
16-4662-10
10 cm/4"



McPherson
16-4663-07
7.5 cm/3"

Suture Forceps, Strabismus Forceps ●— EN
 Suture Pinzetten, Zangen Strabismus ●— DE
 Sutura Pinzas, estrabismo ●— ES



McCullough
 16-4664-09
 9.5 cm/3 3/4"



McCullough
 16-4665-09
 9.5 cm/3 3/4"



Bonaccoito
 16-4666-10
 10 cm/4"



Bonaccoito
 16-4667-10
 10 cm/4"



16-4668-11
 11 cm/4 1/2"



16-4669-11
 1 : 2

16-4670-11
 2 : 3

11 cm/4 1/2"



Nugent
 10 cm/4"



16-4671-01



16-4672-02

EN —● Strabismus, Muscle and Advancement Forceps

DE —● Strabismus, Muskel-und Advancement Zange

ES —● Estrabismo, los músculos y Promoción Pinzas

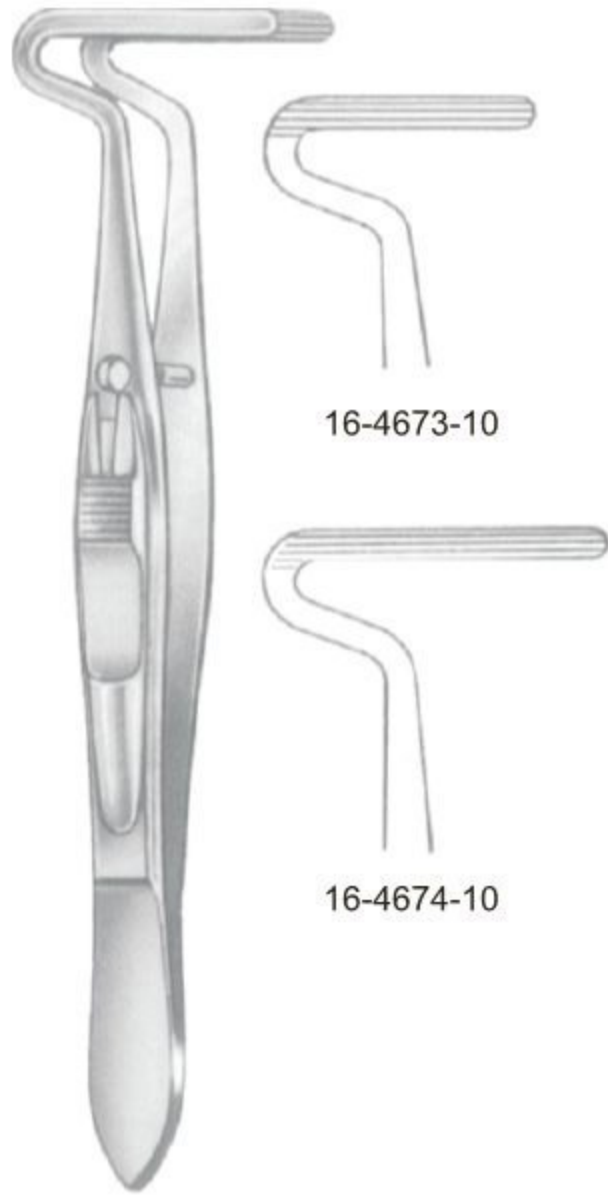

16-4673-10

16-4674-10

Berke
10 cm/4"



Blascovics
16-4675-09
9 cm/3 1/2"



Blascovics
16-4676-09
9 cm/3 1/2"



Worth
16-4677-10
10 cm/4"



Worth
16-4678-10
10 cm/4"



Jameson
16-4679-10
10 cm/4"



Jameson
16-4680-10
10 cm/4"



Prince
16-4681-10
10 cm/4"



Prince
16-4682-10
10 cm/4"

Entropium, Anterior Chamber Forceps ● EN
 Entropium, Vorderkammer Zange ● DE
 Entropion, pinzas Cámara Anterior ● ES



Snellen
 16-4683-10
 10 cm/4"



Snellen
 16-4684-10
 10 cm/4"



Erhardt
 16-4685-09
 9 cm/3 1/2"

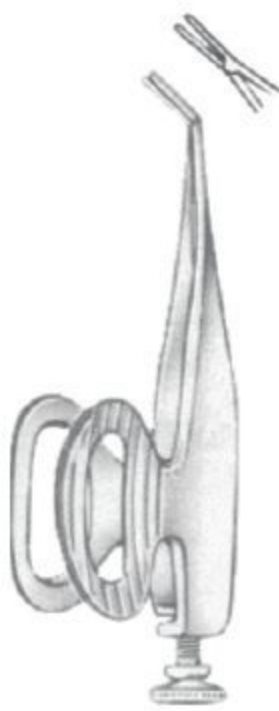

Barraquer
 16-4686-05
 5.5 cm/2 1/4"



Barraquer
 16-4687-07
 5.5 cm/2 1/4"



Barraquer
 16-4688-10
 5.5 cm/2 1/4"

- EN —● Iris Forceps
- DE —● Iris Zange
- ES —● Iris Pinzas



Iris Forceps ●— EN
 Iris Zange ●— DE
 Iris Pinzas ●— ES



Graefe
10 cm/4"



16-4696-10



16-4697-10



16-4698-10



16-4699-10



16-4700-10



16-4701-10

Conjunctival forceps



Stevens
10.5 cm/4¼"



16-4702-10



16-4703-10



16-4704-10



O'Connor
16-4708-10
10 cm/4"



16-4705-10



16-4706-10



16-4707-10



Stevens
16-4709-11
11 cm/4½"



Stevens
16-4710-11
11 cm/4½"

EN —● Iris, Fixation and Capsular Forceps
 DE —● Iris, Fixierung und Kapsel-Pinzetten
 ES —● Iris, la fijación y pinzas capsulares



Fischer
 16-4711-07
 7 cm/2 3/4"



Fischer-Arit
 16-4712-07
 7 cm/2 3/4"



Hess
 16-4713-07
 7 cm/2 3/4"



Hess
 16-4714-07
 7 cm/2 3/4"



Smooth **Chandler** Serrated
 16-4715-01 7 cm/2 3/4" 16-4716-02



Fuchs
 16-4717-07
 7 cm/2 3/4"



Gill-Hess
 16-4718-07
 7.5 cm/3"



Gill-Hess Teeth Below
 16-4719-07 7.5 cm/3"
 16-4720-07 Teeth on side



Barraquer-Katzin
 (Colibri)
 16-4721-07
 7 cm/2 3/4"

Capsular Forceps ●— EN
 Kapsel-Pinzetten ●— DE
 capsular Pinzas ●— ES



Fuchs
 16-4722-07
 7 cm/2 ¾"



Kalt
 16-4723-10
 10 cm/4"



Terson
 16-4724-09
 9.5 cm/3 ¾"



Arruga-Nizetic
 16-4725-10
 10 cm/4"



Castroviejo
 16-4726-10
 10 cm/4"



Castroviejo
 16-4727-10
 10 cm/4"



Elschnig
 16-4728-10
 10 cm/4"

For Len Implantation



Binkhorst
 16-4729-07
 7 cm/2 ¾"



Arruga
 16-4730-09
 9.5 cm/3 ¾"



Arruga
 16-4731-09
 9.5 cm/3 ¾"



Knapp
16-4732-11
11 cm/4¼"



Ayer
16-4733-09
9 cm/3½"



Ayer
16-4734-09
9 cm/3½"



Lambert
16-4735-09
9 cm/3½"



Desmarres
9 cm/3½"



16-4736-01



16-4737-02



16-4738-03

Iridectomy Scissors ●— EN
 Iridektomie Scissors ●— DE
 Tijeras iridectomía ●— ES



Fig. 1



Fig. 2



Fig. 3



Noyes
 Fig.1 16-4739-01
 Fig.2 16-4739-02
 Fig.3 16-4739-03
 12 cm/4 ¾"



Noyes
 16-4740-12
 12 cm/4 ¾"



Wecker
 11.5 cm/4½"



16-4741-01



16-4742-02



Barraquer
 16-4743-05
 5.5 cm/2 ¼"



16-4744-09
 9 cm/3 ½"



16-4745-09



16-4746-09



16-4747-09



16-4748-09



16-4749-09

- EN —● Iridectomy Scissors
- DE —● Iridektomie Scissors
- ES —● Tijeras iridectomía



Straight

Vannas
16-4750-08
8 cm/3 1/4"



Curved

Vannas
16-4751-08
8 cm/3 1/4"

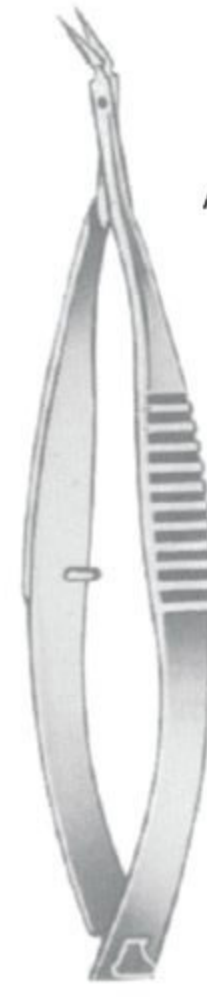

Angular

Vannas
16-4752-08
8 cm/3 1/4"

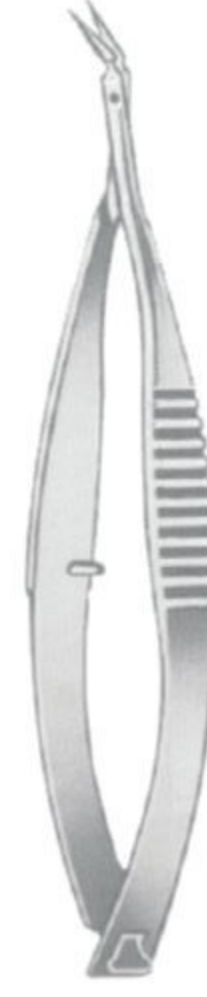

Vannas
16-4753-08
8 cm/3 1/4"



Straight

16-4754-08
8.5 cm/3 1/4"



Curved

16-4755-08
8.5 cm/3 1/4"



Angular

16-4756-08
8.5 cm/3 1/4"



Angular

16-4757-08
8.5 cm/3 1/4"

Vannas Mod, Tubingen

Iridectomy Scissors ●— EN
 Iridektomie Scissors ●— DE
 Tijeras iridectomía ●— ES



16-4758-10
10 cm/4"



16-4759-10
10 cm/4"



Castroviejo
16-4760-10
10 cm/4"



Castroviejo
16-4761-10
10 cm/4"



Aebli
16-4762-10
10 cm/4"

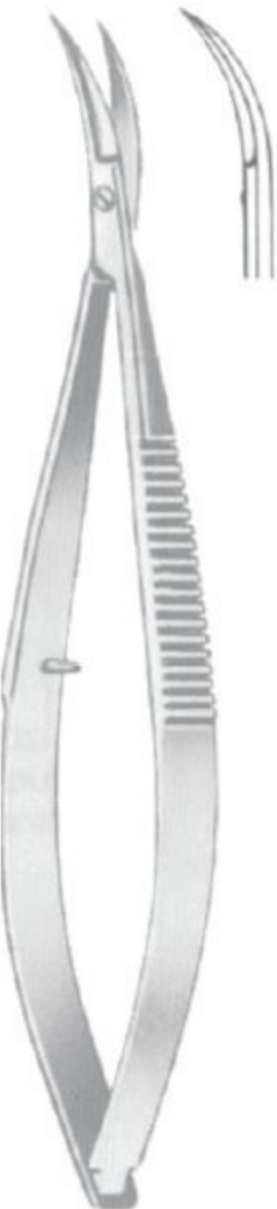

Castroviejo
16-4763-10
10 cm/4"



Castroviejo
16-4764-10
10 cm/4"

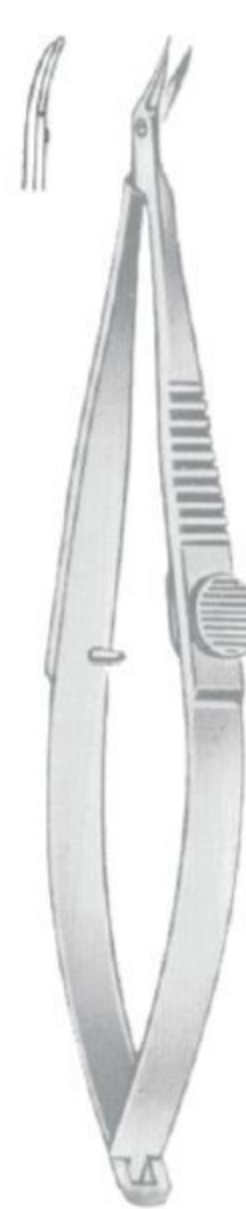

Troutman-Barraquer
16-4765-10
10 cm/4"

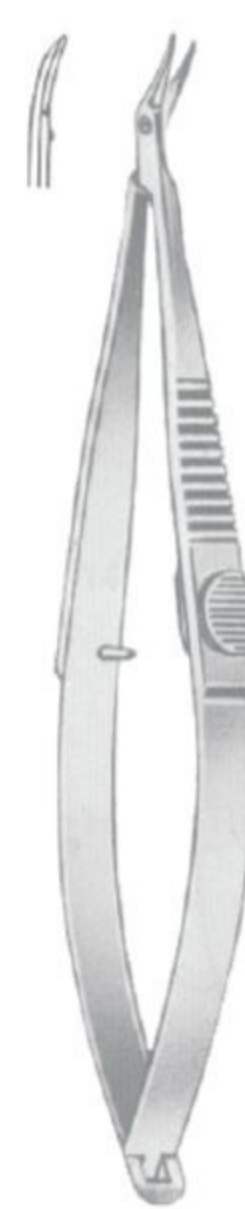

Troutman-Barraquer
16-4766-10
10 cm/4"

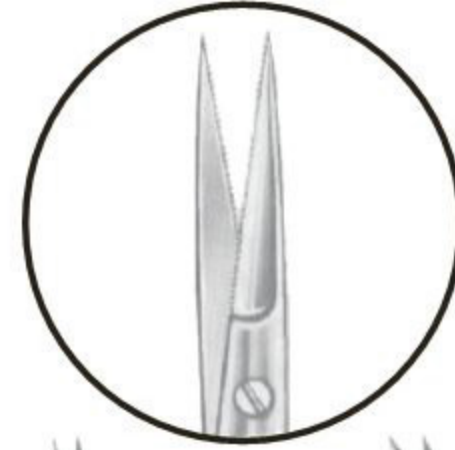

Saw Edge

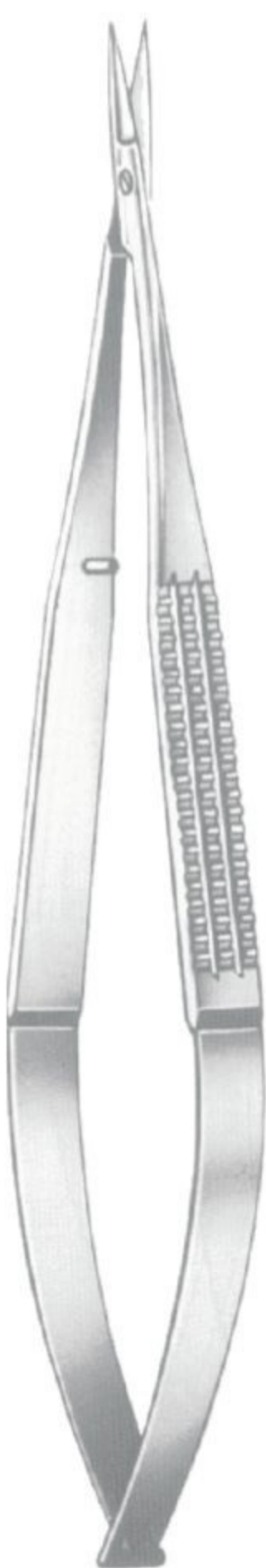

Straight
16-4767-16
16cm/6 1/4"

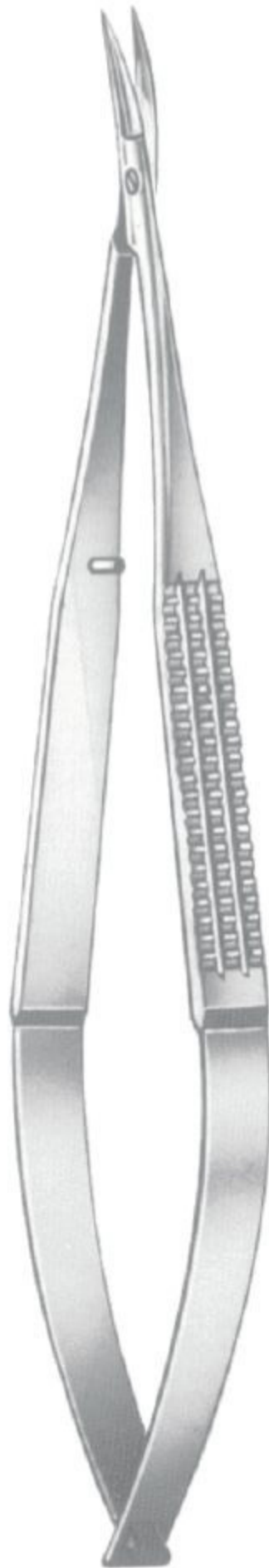

Curved
16-4768-16
16cm/6 1/4"



Straight
16-4769-16
16cm/6 1/4"

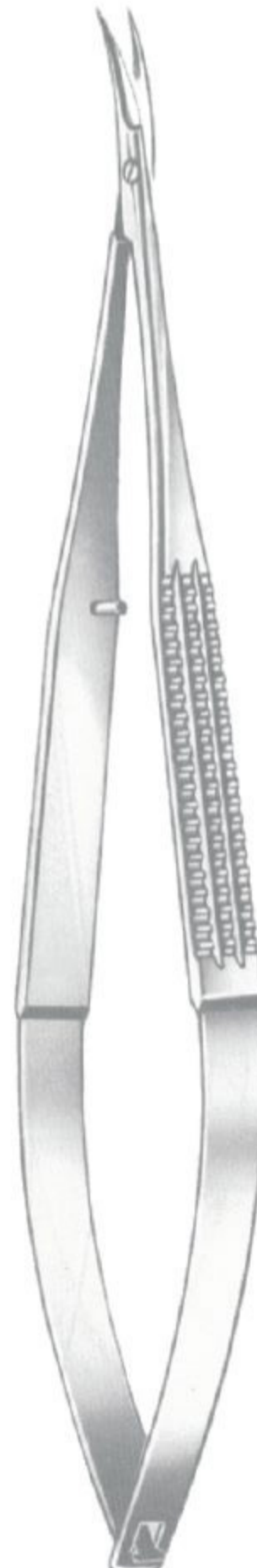

Curved
16-4770-16
16cm/6 1/4"



Millesi
Straight
16-4771-16
16cm/6 1/4"

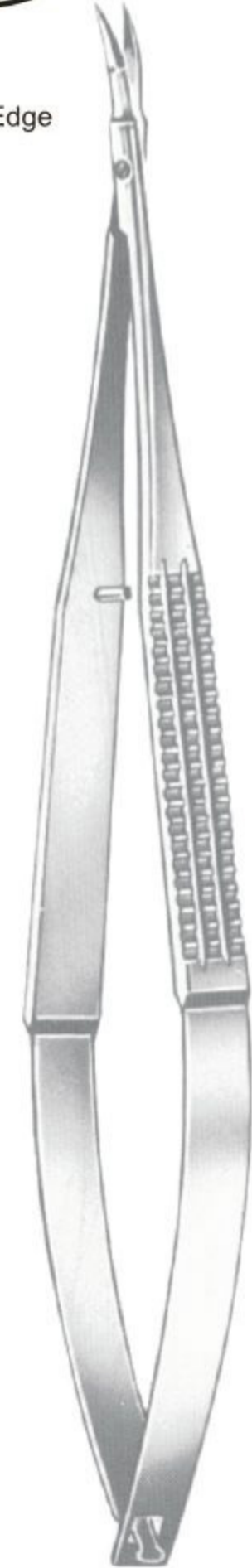

Millesi
Curved
16-4772-16
16cm/6 1/4"

Micro Scissors ● EN
 Mikro-Scheren ● DE
 Micro-Tijeras ● ES



Straight
 16-4773-18
 18.5cm/7 1/4"



Curved
 16-4774-18
 18.5cm/7 1/4"



Angular
 16-4775-18
 18.5cm/7 1/4"



Straight
 16-4776-23
 23cm/9"

Dissecting Scissors



Straight
 16-4777-14
 14.5cm/5 3/4"



Curved
 16-4778-14
 14.5cm/5 3/4"



Curved
 16-4779-14
 14.5cm/5 3/4"