



EN Rhinology

DE Rhinologie

ES Rinología

Page 438 to 462





Fraenkel
18-5001-01 Fig. 1
18-5001-02 Fig. 2
18-5001-03 Fig. 3



18-5002-01
18-5002-02
18-5002-03
13 cm/5"



Fig. 1
18-5003-01
18-5003-01

Fig. 2
18-5004-02
18-5004-02

Fig. 3
18-5005-03
18-5005-03



18-5006-01
18-5006-02
18-5006-03
13 cm/5"



Hartmann
15 cm/6"

18-5007-01

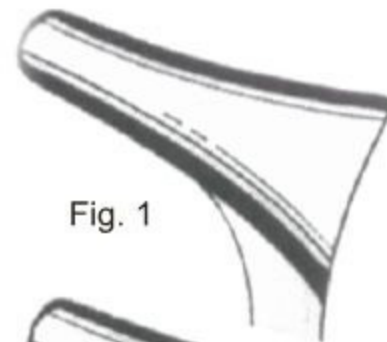

Fig. 1

18-5007-02

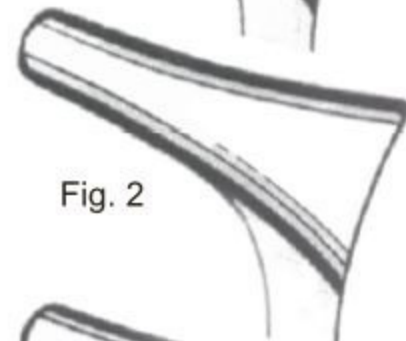

Fig. 2

18-5007-03

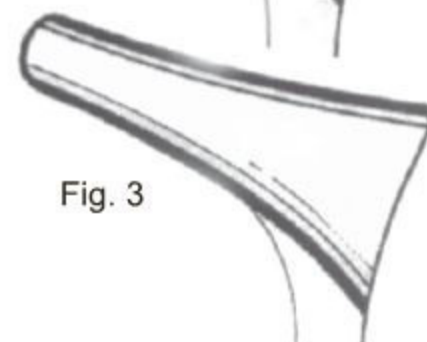

Fig. 3

18-5008-01



Hartmann
15 cm/6"

18-5008-02

18-5008-03



18-5009-01

18-5009-02

18-5009-03

Hartmann-Halle
15 cm/6"

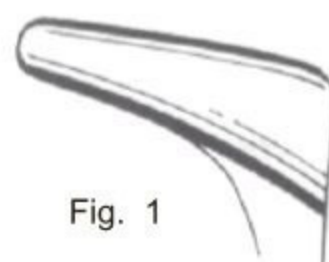

Fig. 1

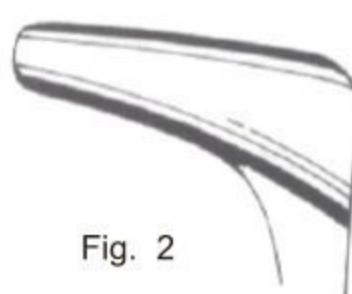

Fig. 2

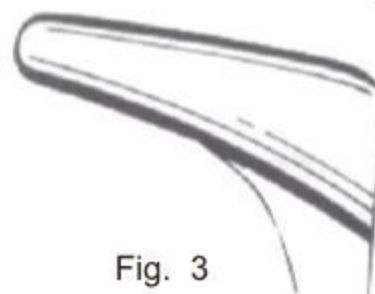

Fig. 3



18-5010-01

18-5010-02

18-5010-03

Hartmann-Halle
15 cm/6"



18-5011-01

18-5011-02

Tieck
13.5 cm/5 1/4"



18-5012-01

18-5012-02



Tieck
13.5 cm/5 1/4"



Beckmann
15 cm/6"



Fig. 1
18-5013-01

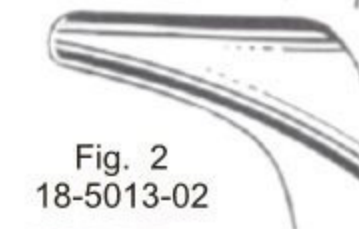

Fig. 2
18-5013-02

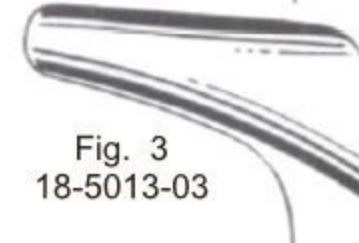

Fig. 3
18-5013-03

EN —● Nasal Speculas
DE —● Nasenspekula
ES —● Espéculos nasales



18-5014-01



18-5015-01

18-5014-02

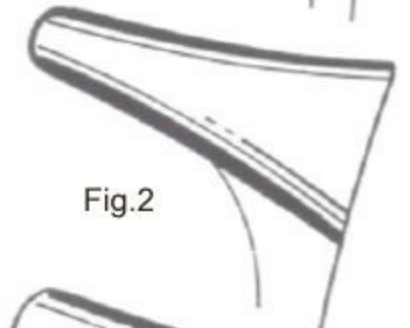

18-5015-02

18-5014-03

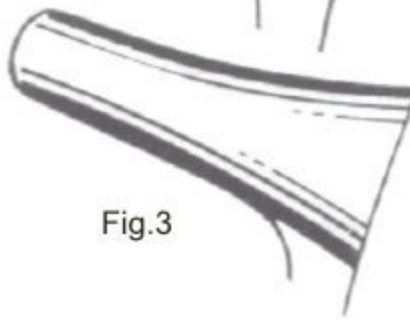

18-5015-03



18-5016-01
35 mm



18-5016-02
50 mm



18-5016-03
75 mm



18-5016-04
90 mm

Nasal Speculas ● EN
 Nasenspekula ● DE
 Espéculos nasales ● ES



Cottle
 18-5017-01
 18-5017-02
 18-5017-03
 18-5017-04
 15 cm/6"

Cottle
 18-5018-01
 18-5018-02
 18-5018-03
 18-5018-04
 15 cm/6"



Fig 1
 18-5017-01
 18-5018-01
 35 mm



Fig 2
 18-5017-02
 18-5018-02
 50 mm



Fig 3
 18-5017-03
 18-5018-03
 75 mm



Fig 4
 18-5017-04
 18-5018-04
 90 mm



Thudicum Nasal Speculum
 Length 7 cm

- 18-5019-30 No. 1-3 (set of 3)
- 18-5019-40 No. 1-4 (set of 4)
- 18-5019-70 No. 1-7 (set of 7)



18-5019-01
 No. 1



18-5019-02
 No. 2



18-5019-03
 No. 3



18-5019-04
 No. 4



18-5019-05
 No. 5

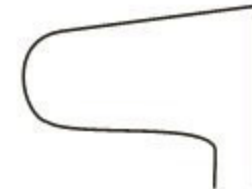

18-5019-06
 No. 6

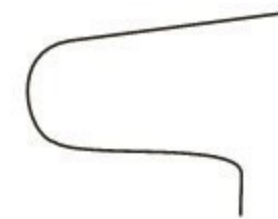

18-5019-07
 No. 7

EN —● Nasal Snares, Dressing and Tampon Forceps

DE —● Polypenschnürer, Tamponpinzetten und -zangen

ES —● Polipótomos, Pinzas para compresas y tanopamientos



Krause
18-5020-26
26 cm/10¼"



Krause-Voss
18-5021-26
26 cm/10¼"



Lange-Wilde
18-5022-24
24 cm/9½"

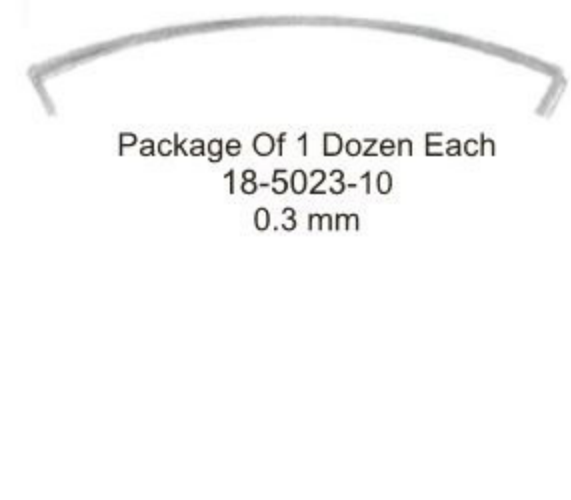

Package Of 1 Dozen Each
18-5023-10
0.3 mm



Cm	In	Troeltsch (Wilde)
15.0	6	18-5024-15
18.0	7	18-5024-18
20.0	8	18-5025-20



Cm	In	Gruenwald (Jansen)
15.0	6	18-5025-16
18.0	7	18-5025-18
20.0	8	18-5025-20



Westmacott (West)
18-5026-20
20 cm/8"



Lubet-Barbon
18-5027-20
20 cm/8"

Nasal Polypus and Septum Compression Forceps ● EN

Polypenzangen, Septumzange ● DE

Pinzas para pólipos, Pinza para el tabique nasal ● ES



Hartmann
18-5028-16
16 cm/6 1/4"

Hartmann
18-5029-20
20 cm/8"

Heymann
18-5030-18
18 cm/7"

Craig
18-5031-18
18 cm/7"

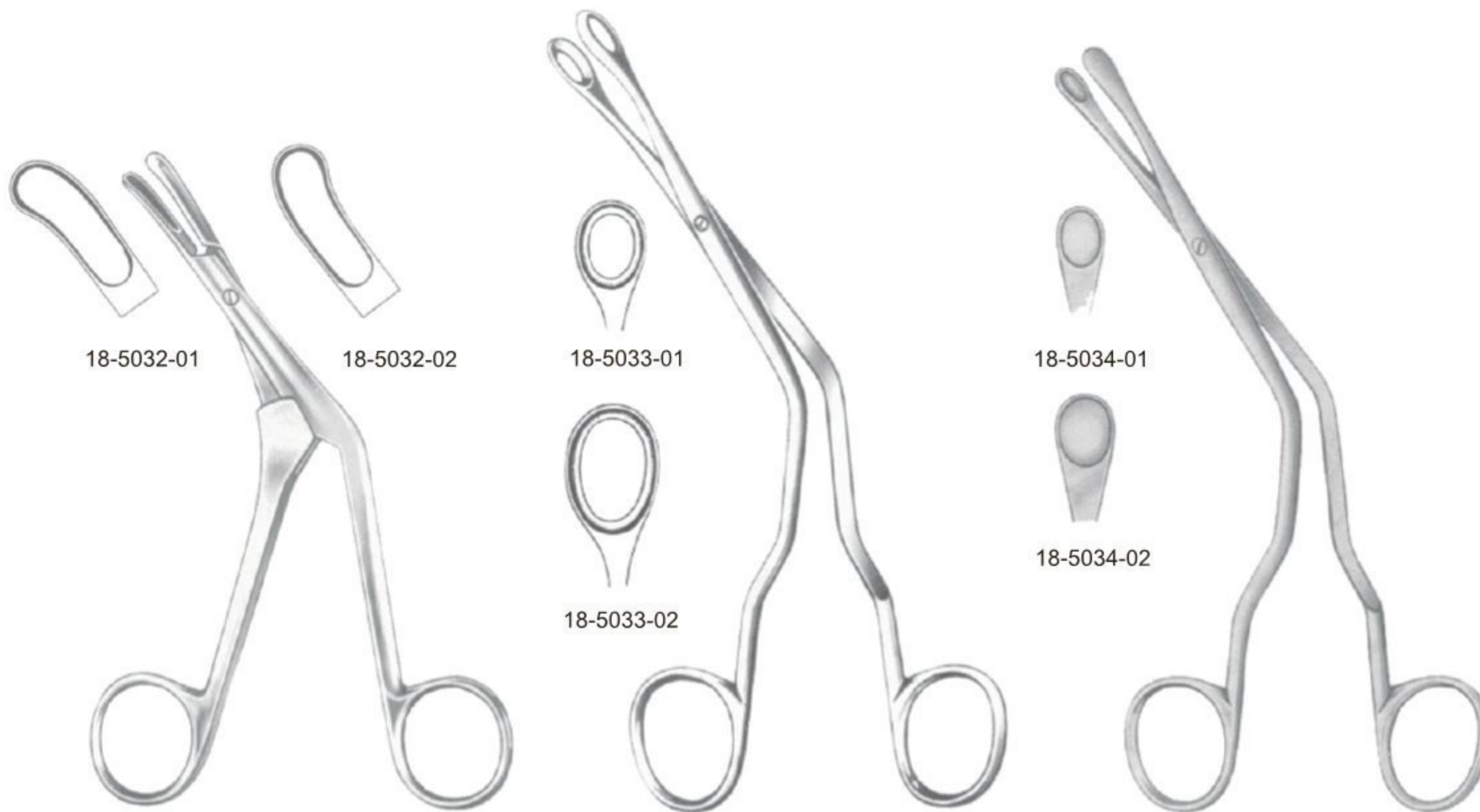

18-5032-01

18-5032-02

18-5033-01

18-5034-01

18-5033-02

18-5034-02

Craig Domnick
18 cm/7"

Luc
20 cm/8"

Luc
20 cm/8"



Bruenings
19 cm/7½"

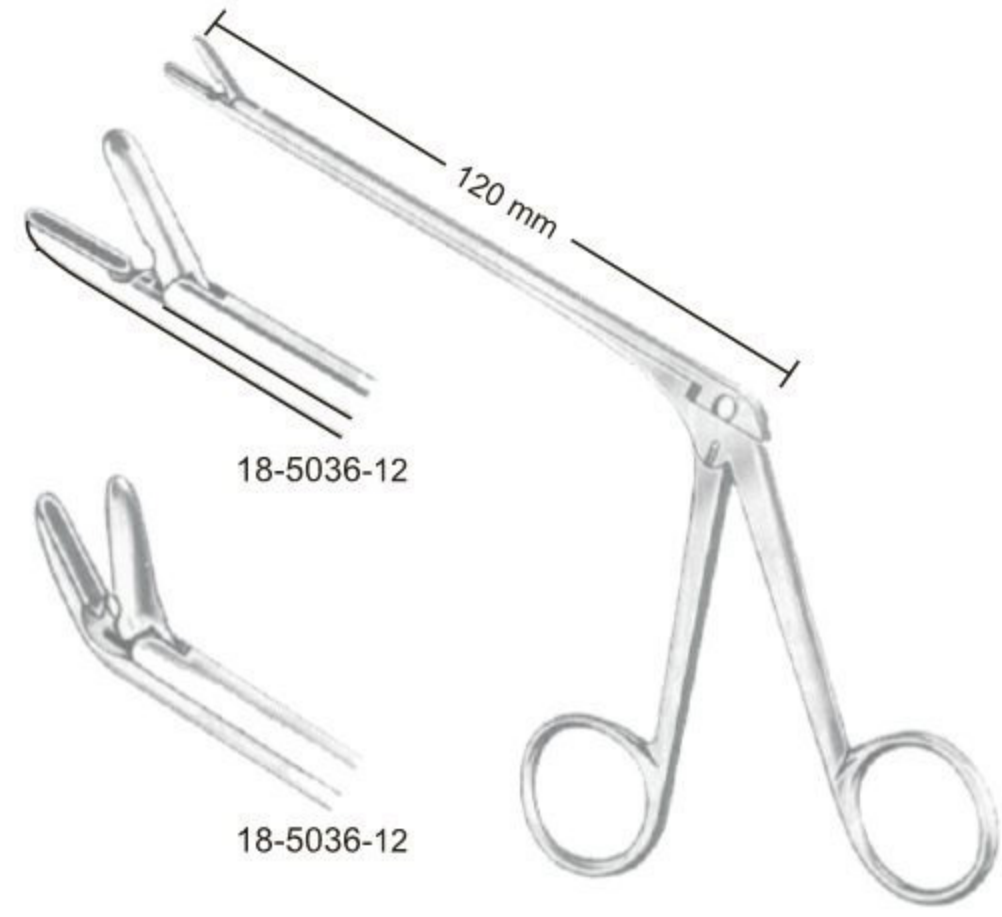

Takahashi
19 cm/7½"



Watson-Williams
19 cm/7½"



Ferris-Smith
18-5038-12
19 cm/7½"

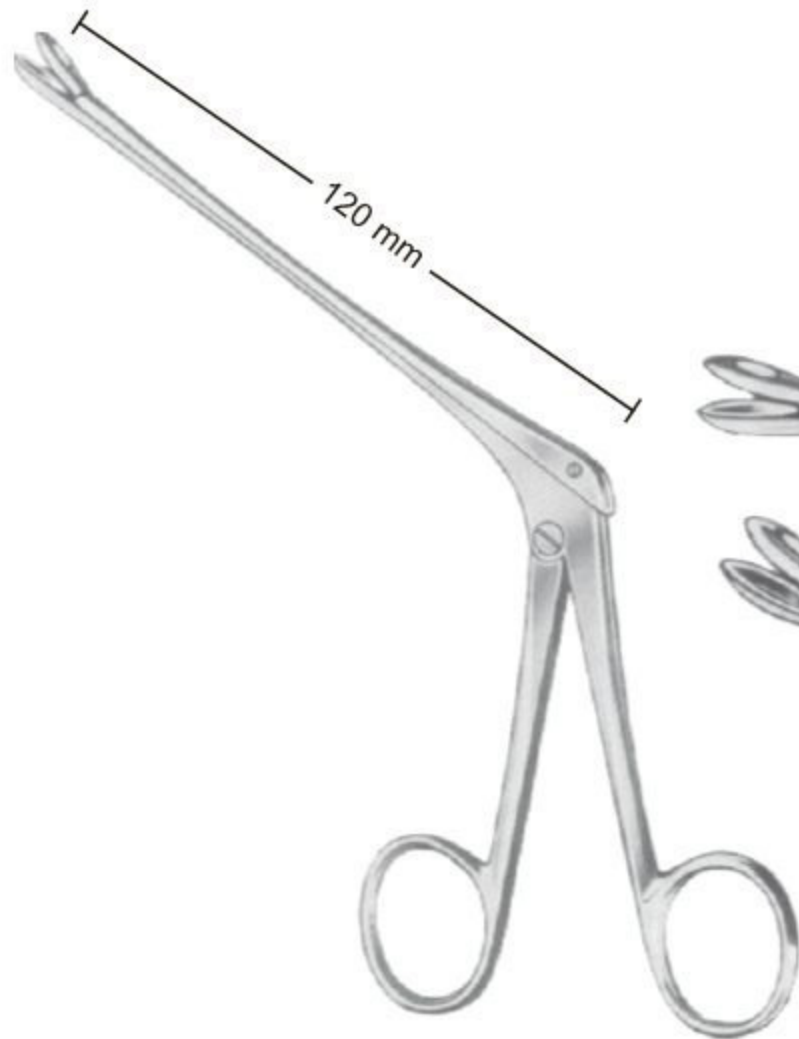

Weil-Blakesley

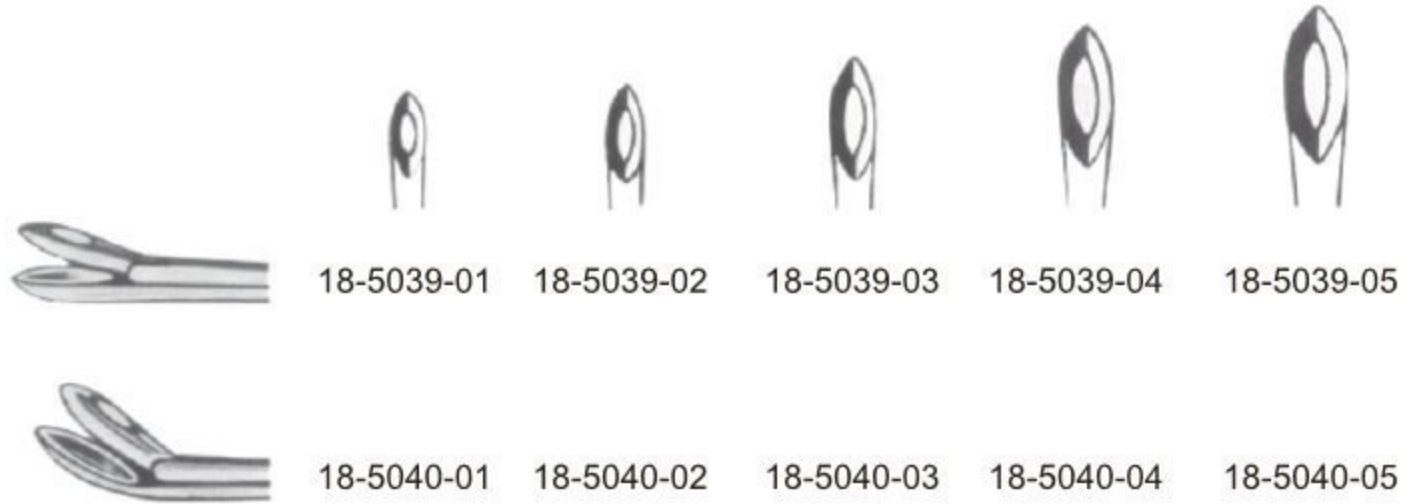

Struycken

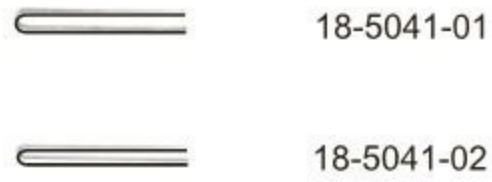

Hajek

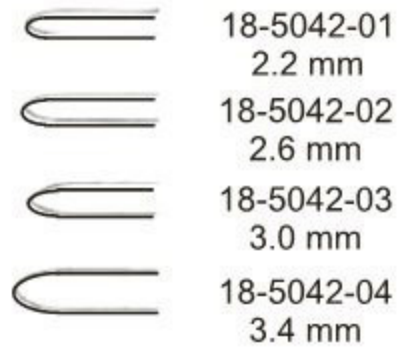

Myles

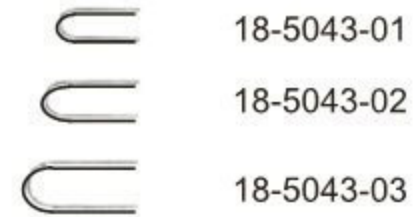

Grunwald



Hartmann

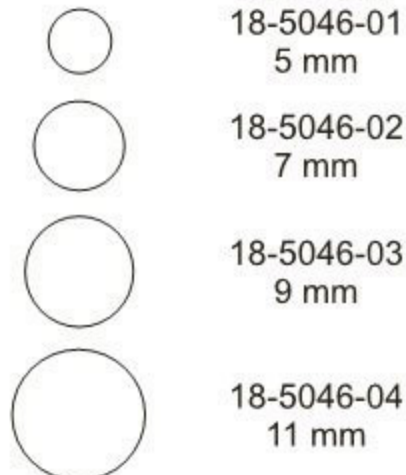

Schmeden

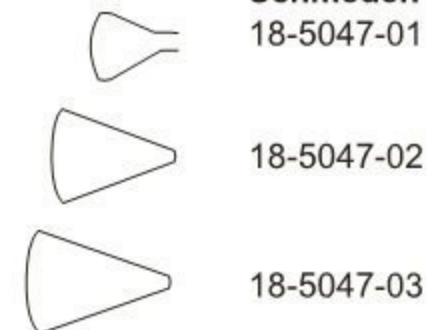

Grunwald
18-5045-01

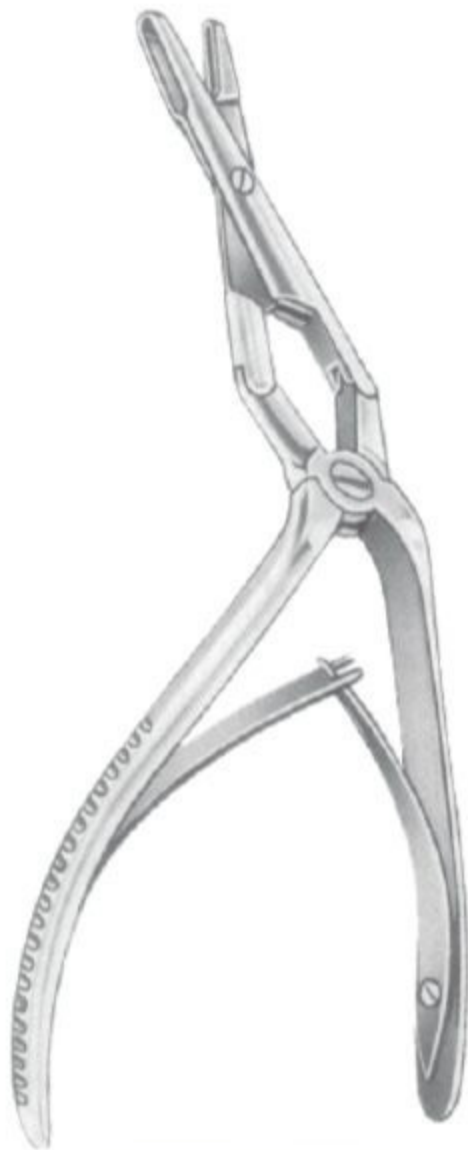

Middleton-Jansen
 18-5048-19
 19 cm/7½"



Middleton-Jansen
 18-5049-19
 19 cm/7½"



Kazanjian
 18-5050-18
 18 cm/7"



Caplan
 18-5051-20
 20 cm/8"

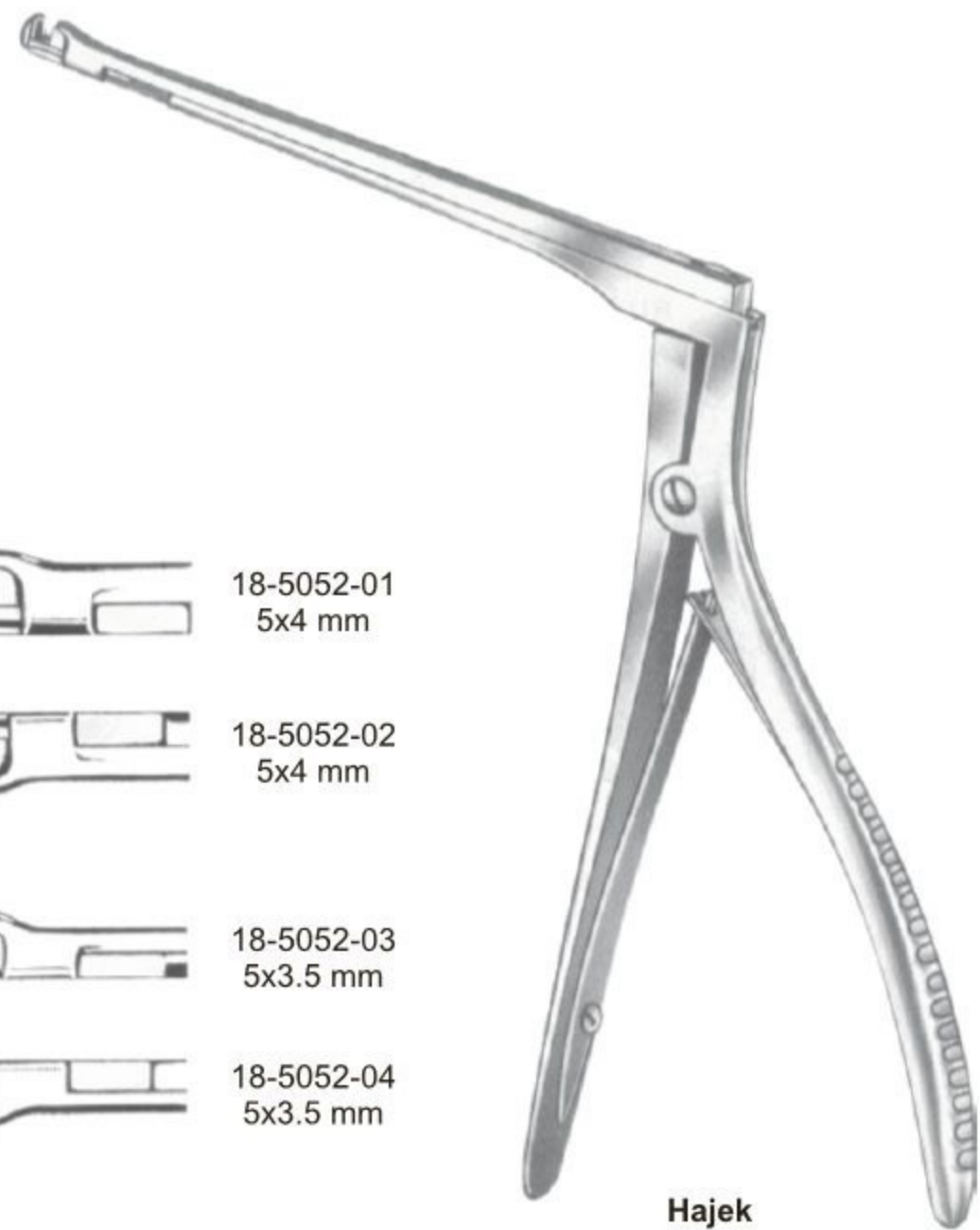
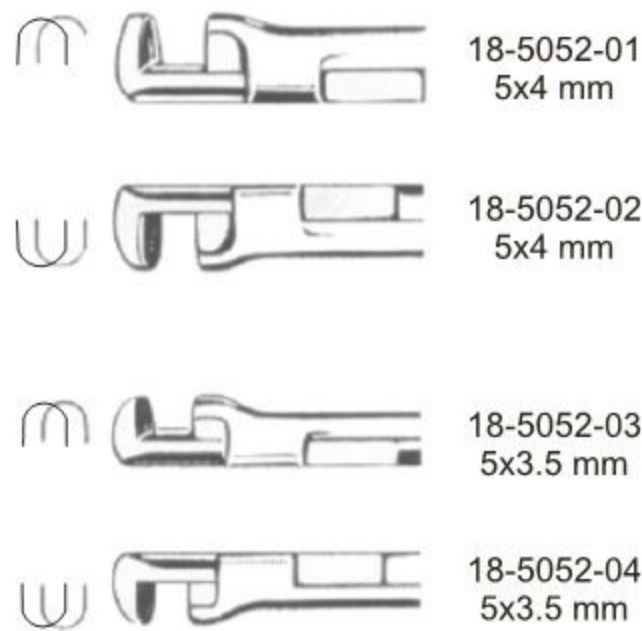

**Hajek
 (Hajek-Kofler)
 Shaft**
 14 cm/5½"



Ferris-Smith-Kerrison



Ferris-Smith-Kerrison

		Width of Bite			Length of Shaft		
		15 cm/6"	20 cm/8"	18 cm/7"	15 cm/6"	20 cm/8"	18 cm/7"
Cutting Upward		18-5053-03	3 mm	18-5056-03	18-5059-03	1 mm	18-5067-01
		18-5053-05	5 mm	18-5056-05	18-5059-05	2 mm	18-5067-02
						3 mm	18-5067-03
						4 mm	18-5067-04
						5 mm	18-5067-05
Cutting Upward 40°		18-5054-03	3 mm	18-5057-03		1 mm	18-5068-01
		18-5054-05	5 mm	18-5057-05		2 mm	18-5068-02
						3 mm	18-5068-03
						4 mm	18-5068-04
						5 mm	18-5068-05
Cutting Downward		18-5055-03	3 mm	18-5058-03	18-5060-03	1 mm	18-5069-01
		18-5055-05	5 mm	18-5058-05	18-5060-05	2 mm	18-5069-02
						3 mm	18-5069-03
						4 mm	18-5069-04
						5 mm	18-5069-05



360° Turnable

Hajek-Kofler
 18-5070-16
 16 cm/6½"

18-5071-03
 3 mm
 18-5071-04
 4 mm
 18-5071-05
 5 mm
 18-5071-06
 6 mm



Kerrison
 20 cm/8"



Jurasz
22 cm/8¾"



18-5072-01



18-5072-02



18-5072-03

Rhinoplastic and Nasal Knives



Joseph
Pointed

← Straight
18-5073-01



Curved
18-5074-01



Joseph
Blunt

← Straight
18-5075-01



Curved
18-5076-01



Converse
18-5077-15
15 cm/6"



Joseph
18-5078-14
14 cm/5½"



Cottle
18-5079-15
15 cm/6"



Cottle
18-5080-14
14 cm/5½"



Freer
18-5081-16
16 cm/6¼"



Joseph
18-5082-16
16.5 cm/6½"



Maltz
18-5083-16
16.5 cm/6½"



Freer
18-5084-19
19 cm/7½"

Septum Knives



Ballenger
20cm/8"



18-5085-03 3 mm 18-5086-03
 18-5085-04 4 mm 18-5086-04
 18-5085-05 5 mm 18-5086-05



Ballenger
20cm/8"



Bruenings
18-5087-16



18-5088-04 4 mm
 18-5088-05 5 mm

Mc Kenty
15 cm/6"



Halle
18-5089-16
16.5 cm/6½"



Joseph
18-5090-16
16.5 cm/6½"



Cottle
18-5091-19
19.5 cm/7½"



Blunt

Freer
18-5092-19
19 cm/7½"



Sharp

Freer
18-5093-19
19 cm/7½"



Freer
18-5094-18
18 cm/7"



Freer-Yasargil
18-5095-18
18.5 cm/7¼"



Howarth
18-5096-21
21.5 cm/8½"



Mc Kenty
18-5097-22
22 cm/8¾"

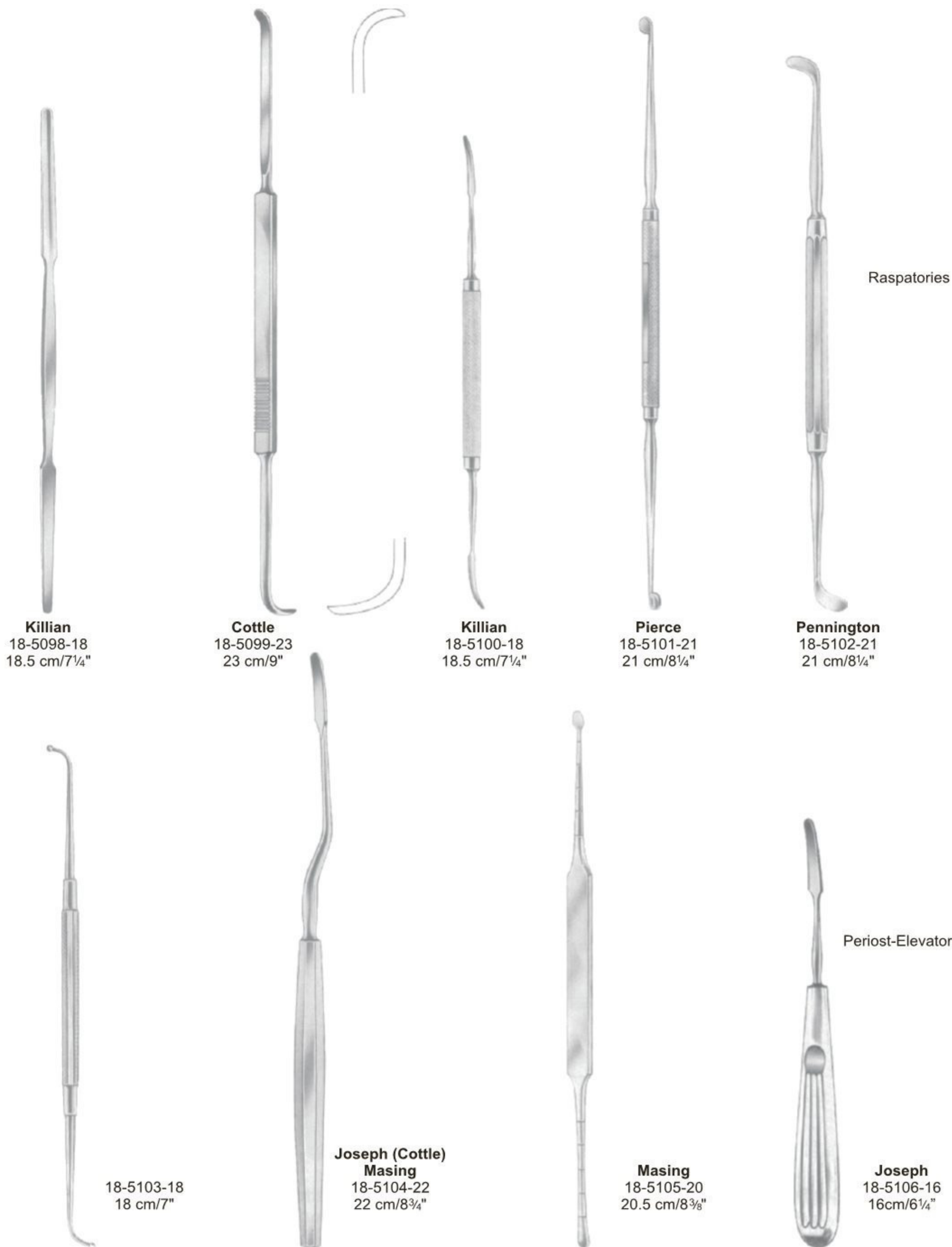

Killian
18-5098-18
18.5 cm/7¼"

Cottle
18-5099-23
23 cm/9"

Killian
18-5100-18
18.5 cm/7¼"

Pierce
18-5101-21
21 cm/8¼"

Pennington
18-5102-21
21 cm/8¼"

18-5103-18
18 cm/7"

**Joseph (Cottle)
Masing**
18-5104-22
22 cm/8¾"

Masing
18-5105-20
20.5 cm/8⅜"

Joseph
18-5106-16
16cm/6¼"

Raspatories

Periost-Elevators

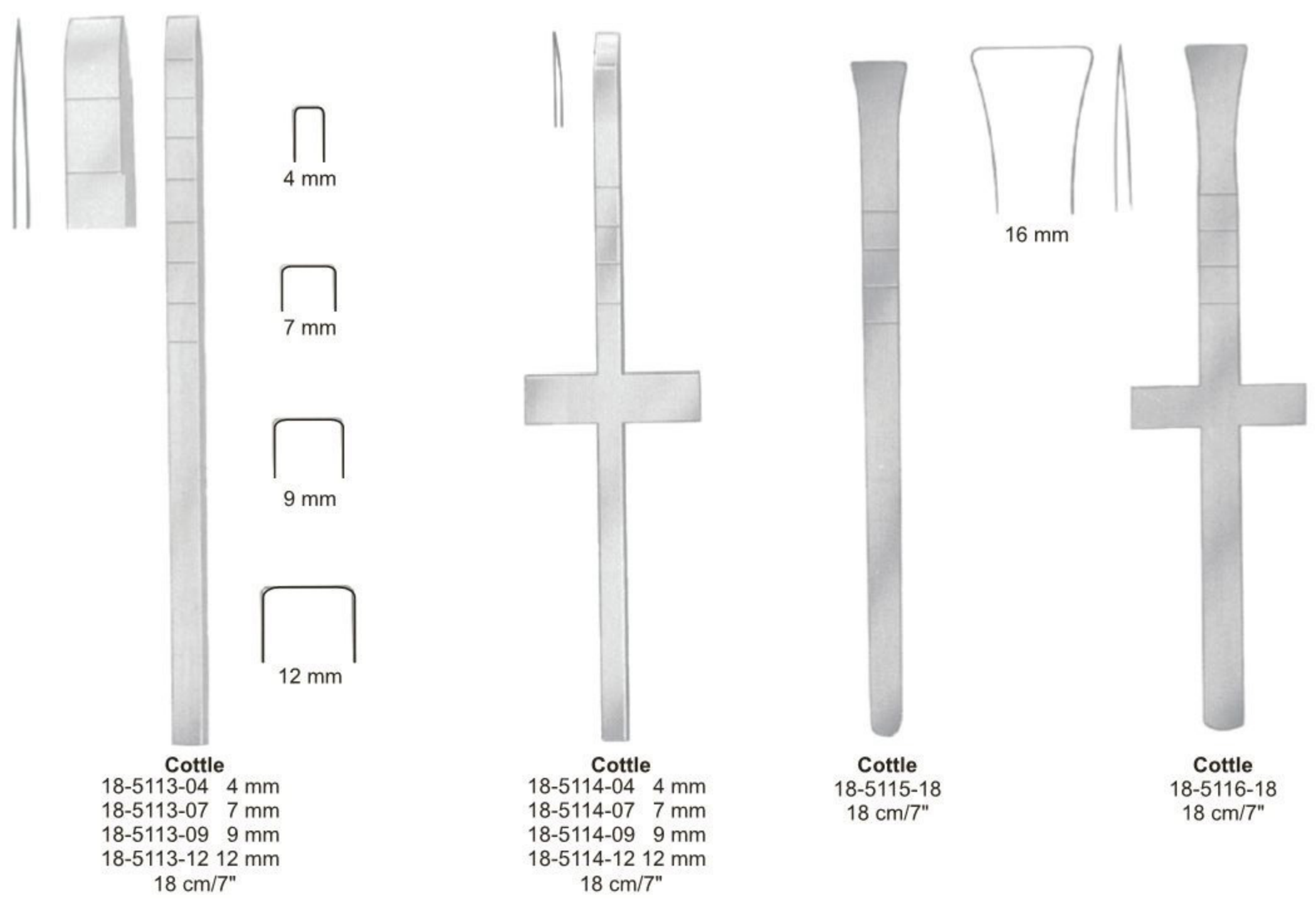
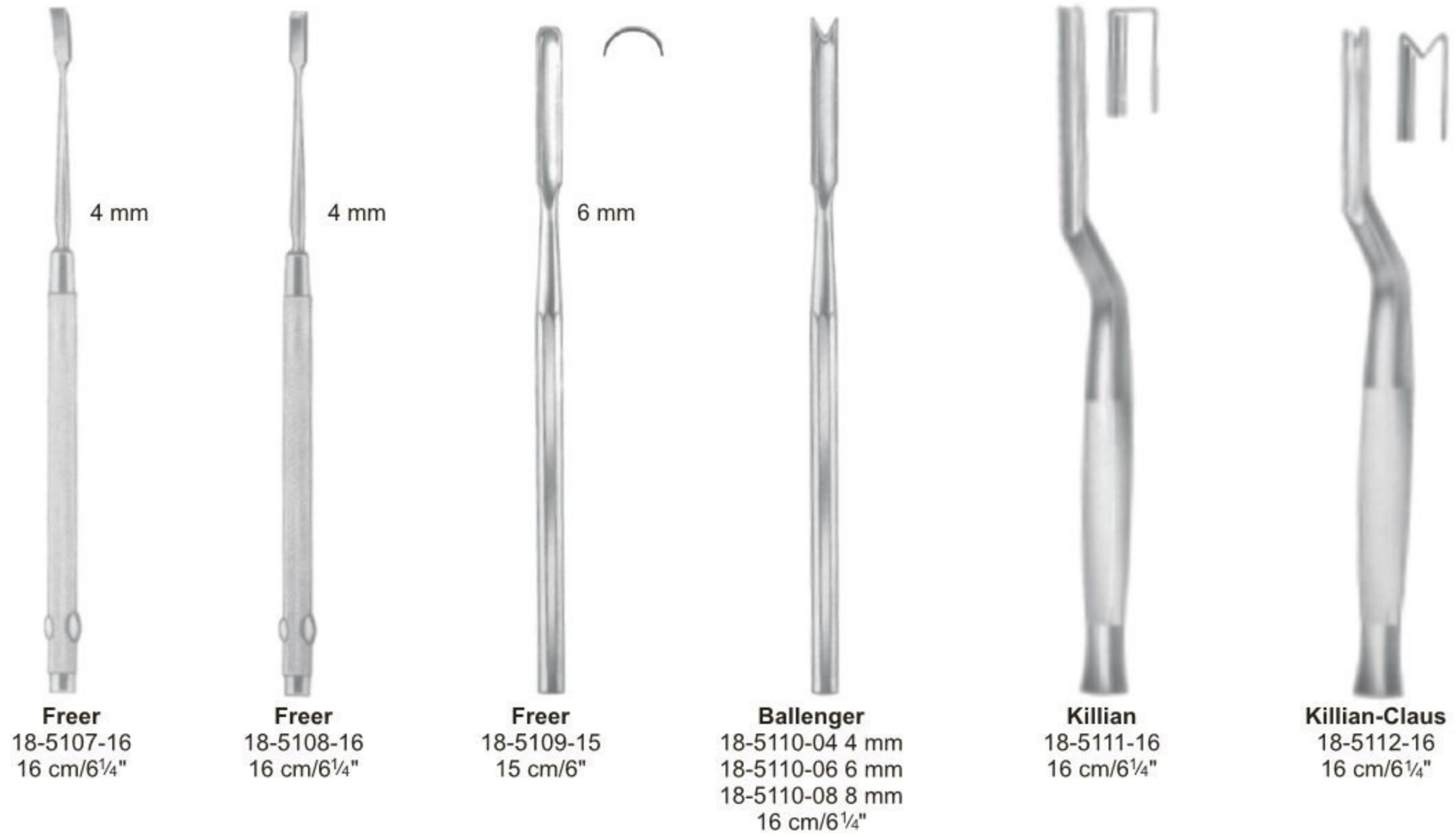

Nasal Septum Chisels ● EN
 Nasenscheidewand Meißel ● DE
 Tabique nasal Cinceles ● ES



18-5117-08
 16 cm/6¼"
 8 mm



Cottle
 18-5118-04 4 mm
 18-5118-07 7 mm
 18-5118-09 9 mm
 18-5118-12 12 mm
 18 cm/7"



Cottle
 Curved
 18-5119-06
 18 cm/7"
 6 mm



Fomon
 18-5120-05 5mm
 18-5120-08 8mm
 17 cm/6¾"



Walter
 18-5121-03 3 mm
 18-5121-04 4 mm
 18 cm/7"



18-5122-01



(Silver) Masing
 18-5123-02
 17.5 cm/7⅞"



18-5124-03

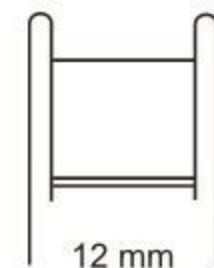
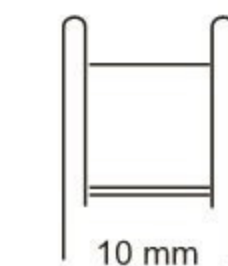

Cinelli
 18-5125-10 10 mm
 18-5125-12 12 mm
 18-5125-14 14 mm
 18-5125-16 16 mm
 16 cm/6¼"



Masing
 18-5126-17
 17.5 cm/6⅞"



West
18-5127-16
16 cm/6¼"



West
18-5128-16
16 cm/6¼"



18-5129-01

18-5129-02

Joseph
17 cm/6¾"



Joseph
18-5130-01
17 cm/6¾"



Joseph
18-5131-02
17 cm/6¾"



Joseph
18-5132-03
17 cm/6¾"

Rasps with TC ●— EN
 Raspeln mit TC ●— DE
 Escofinas con TC ●— ES

TC



Fig.1



Fig.3



Fig.5



Fig.7



Fig.9



Fig.2



Fig.4



Fig.6



Fig.8



Fig.10

Famon

- Fig. 1/ 2 18-5133-12
- Fig. 3/ 4 18-5133-34
- Fig. 5/ 6 18-5133-56
- Fig. 7/ 8 18-5133-78
- Fig. 9/10 18-5133-90

21 cm/8 1/4"

TC



Parkes

- Fig. 1 18-5134-01
- Fig. 2 18-5134-02
- Fig. 3 18-5134-03
- Fig. 4 18-5134-04
- Fig. 5 18-5134-05
- Fig. 6 18-5134-06
- Fig. 7 18-5134-07
- Fig. 8 18-5134-08
- Fig. 9 18-5134-09
- Fig.10 18-5134-10

20.5 cm/8 1/8"

Maltz

- Fig. 1 18-5135-01
- Fig. 2 18-5135-02
- Fig. 3 18-5135-03
- Fig. 4 18-5135-04
- Fig. 5 18-5135-05
- Fig. 6 18-5135-06
- Fig. 7 18-5135-07
- Fig. 8 18-5135-08
- Fig. 9 18-5135-09
- Fig.10 18-5135-10

17 cm/6 3/4"



Maltz
18-5141-18
18 cm/7"



Joseph
16 cm/6¼"

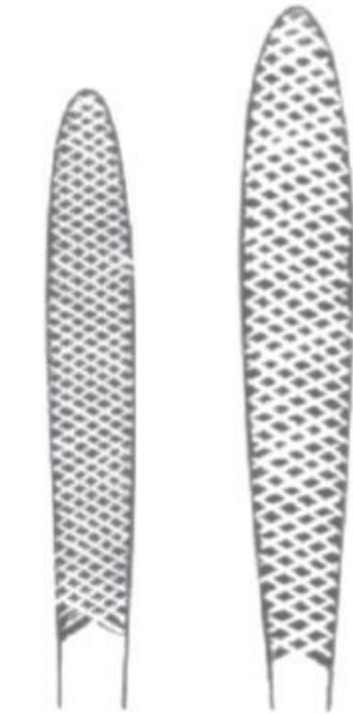

18-5142-01

18-5142-02



Lewis
18 cm/7"



Fine
18-5143-01



Coarse
18-5143-02



Cottle
18-5144-21
21 cm/8¼"



Aufricht
21 cm/8¼"

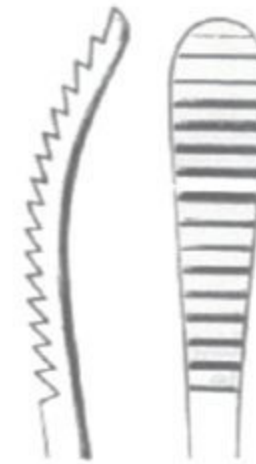

18-5145-01

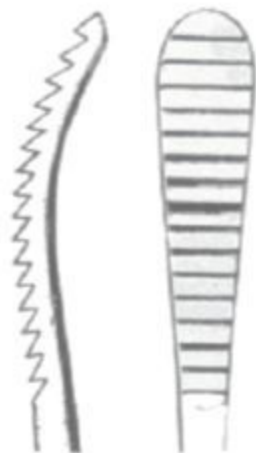

18-5145-02

Rasps with TC ●— EN
 Raspeln mit TC ●— DE
 Escofinas con TC ●— ES



Maltz
17 cm/6¾"



18-5136-01



18-5136-02



Miller
16 cm/6¼"



18-5137-01



18-5137-02



19 cm/7½"



18-5138-02



18-5138-03



18-5138-04



18-5138-05



18-5138-06



18-5138-07



Aufricht
18-5139-17
17.5 cm/6⅞"



Fomon
18-5140-21
21 cm/8¼"



Hooks

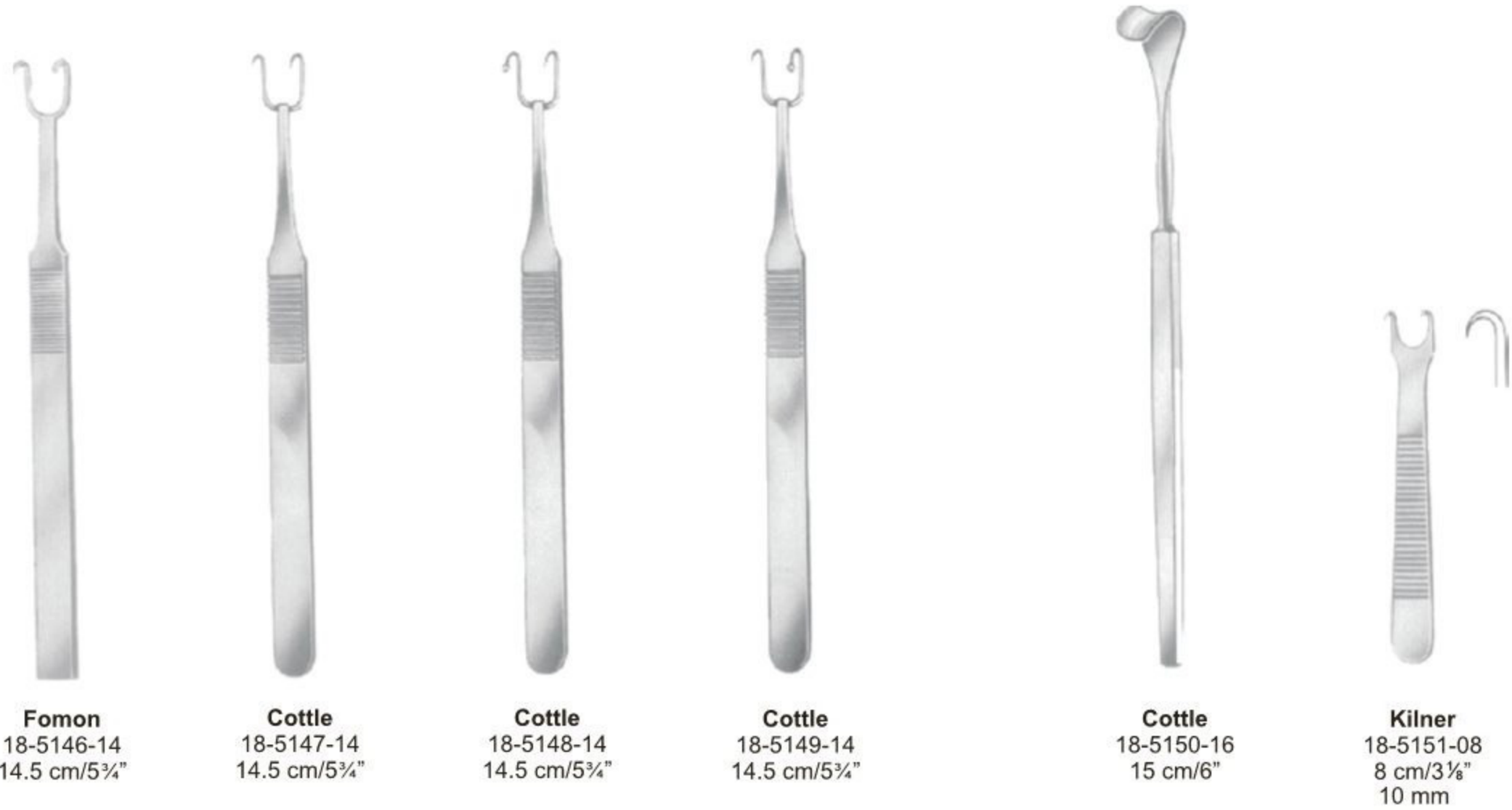

Columella Forceps



Converse
18-5152-12
12 cm/4 3/4"

Aufricht
18-5153-16
16 cm/6 1/4"



Cottle
18-5154-10
10 cm/4"

Tissue Lifter



18-5155-14
14 cm/5 1/2"

Tissue Picks



18-5156-11
11 cm/4 3/8"



1.0 mm 18-5157-10
1.8 mm 18-515718

Septum Straightening and Septum Punch Forceps ● EN
 Septum Straightening und Septum Punch-Zange ● DE
 Tabique y tabique Straightening perforación Pinzas ● ES



Walsham
23 cm/9"



18-5158-01



18-5158-02



18-5158-03



Cottle-Walsham
18-5159-22
22 cm/8¾"



Asch
18-5160-23
23 cm/9"



Kressner
18-5161-20
20 cm/8"



Rubin
18-5162-20
20 cm/8"

EN —● Nasal and Adenoid Curettes
 DE —● Nasal und Adenoid Küretten
 ES —● Nasal y adenoides Curetas



Faulkner
 18-5163-21
 21 cm/8¼"



Sewall
 18-5164-20
 20 cm/8"
 6 mm



Coakley
 17 cm/6¾"



18-5165-01



18-5165-02



18-5165-03



18-5165-04



18-5165-05



18-5165-06

Ringmesser



Beckmann
 22 cm/8¾"

18-5166-01



18-5167-01

18-5166-02



18-5167-02

18-5166-03



18-5167-03

18-5166-04



18-5167-04

18-5166-05



18-5167-05

18-5166-06



18-5167-06

Adenoid Curettes



Negus
 20 cm/8"

Adenoid Currettes ● EN
 Ringmesser ● DE
 Cuchillos para vegetaciones adenoides ● ES

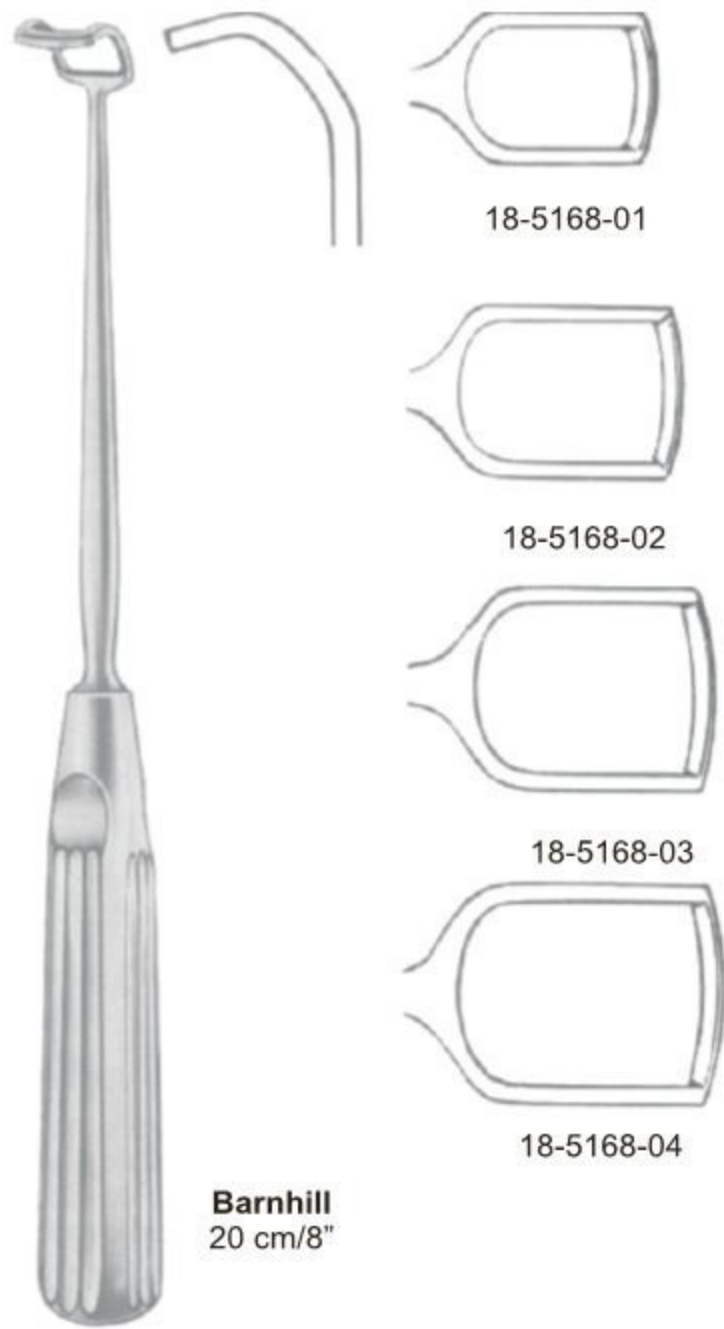

Barnhill
20 cm/8"

18-5168-01

18-5168-02

18-5168-03

18-5168-04

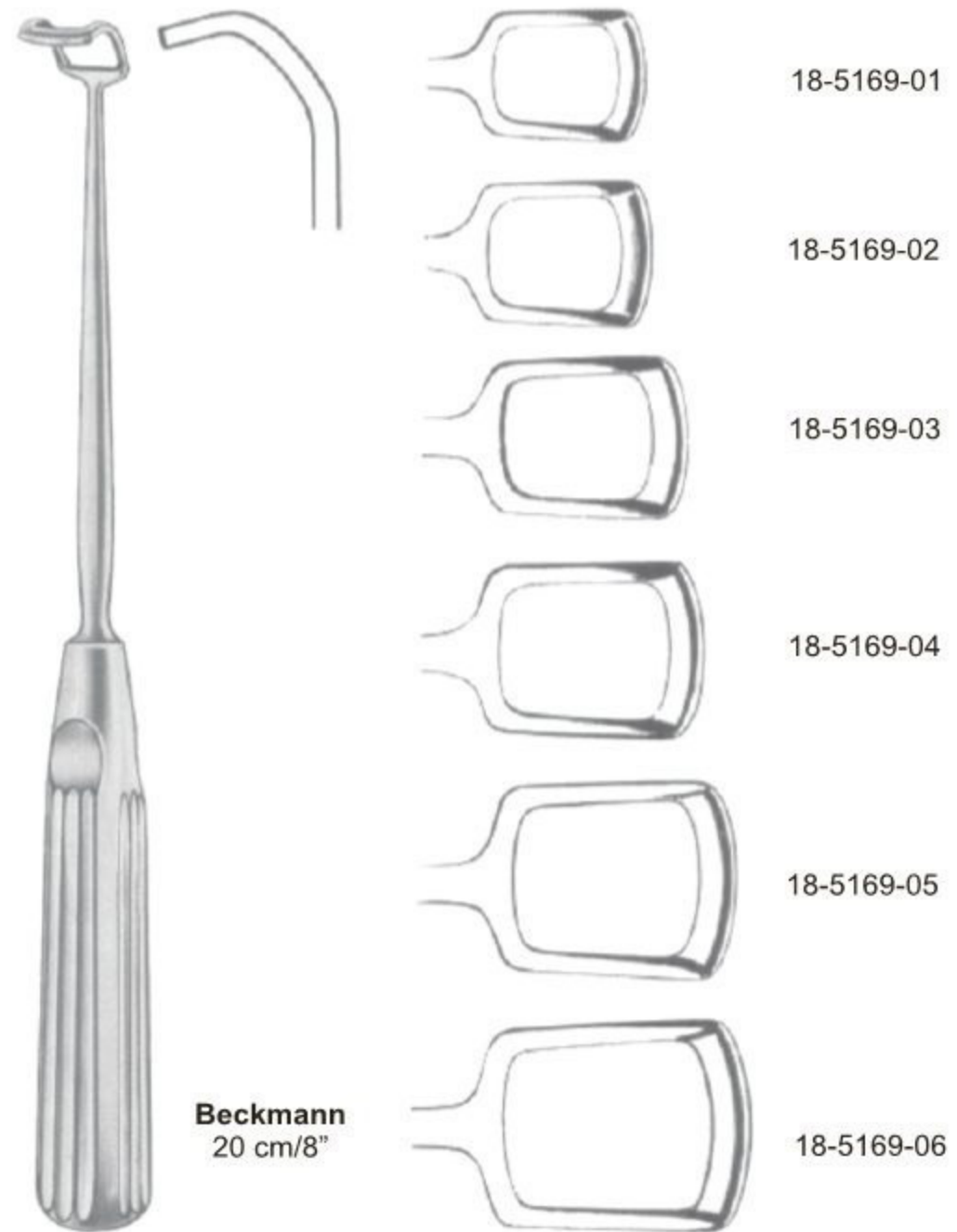

Beckmann
20 cm/8"

18-5169-01

18-5169-02

18-5169-03

18-5169-04

18-5169-05

18-5169-06

18-5170-10 10mm
 18-5170-12 12mm
 18-5170-14 14mm
 18-5170-16 16mm
 18-5170-18 18mm



St. Clair-Thompson
with graded
21.5cm/8 1/2"

18-5170-10A 10mm
 18-5170-12A 12mm
 18-5170-14A 14mm
 18-5170-16A 16mm
 18-5170-18A 18mm



St. Clair-Thompson
without graded
21.5cm/8 1/2"



La Force
23 cm/9"



18-5171-01

18-5171-02

18-5171-03

Spare blades Only

18-5171-11

18-5171-12

18-5171-13

- EN —● Antrum Retractor and Antrum Frontal Sinus Wash Cannulas
- DE —● Nasal und Adenoid CuAntrum Retractor und Antrum Frontal Sinus Wash Kanülen
- ES —● Nasal y adenoides CuAntrum Retractor y el antro del seno frontal lavado cánulas



Bruenings- Brunk
18-5172-19
91 cm/7½"

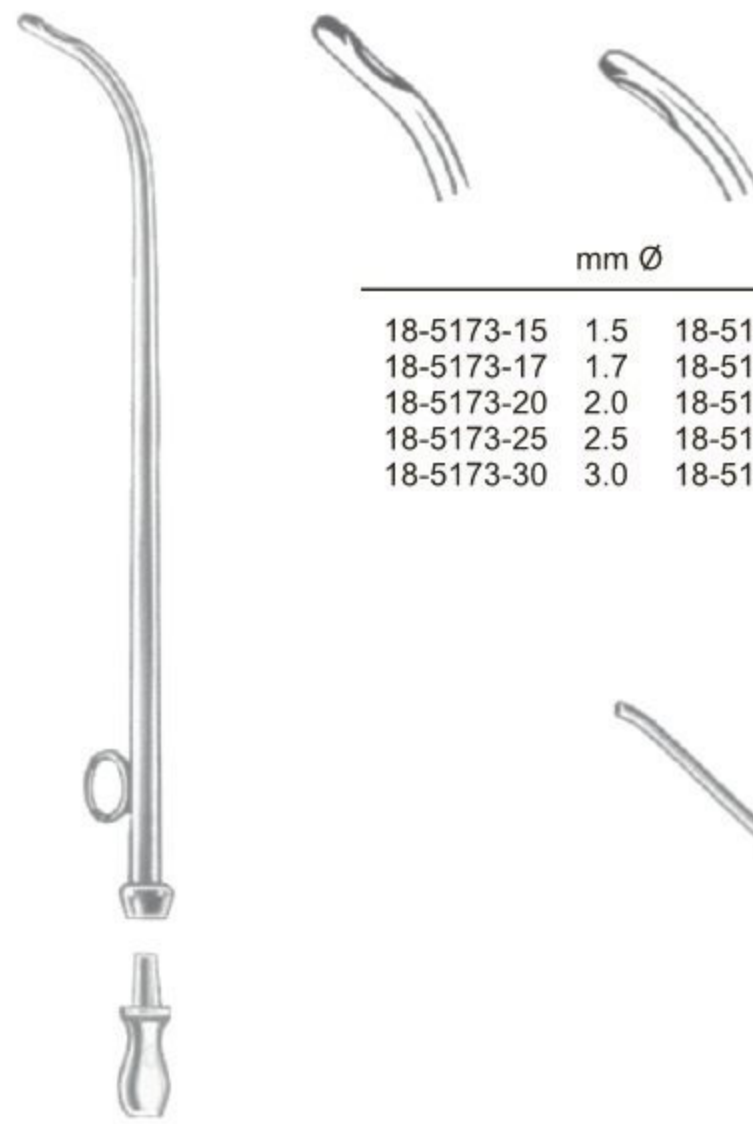

Siebenmann

mm Ø		
18-5173-15	1.5	18-5174-15
18-5173-17	1.7	18-5174-17
18-5173-20	2.0	18-5174-20
18-5173-25	2.5	18-5174-25
18-5173-30	3.0	18-5174-30



Hartmann

Fig. 1	mm Ø	Fig. 2
18-5175-20		18-5176-20
18-5175-25		18-5176-25
18-5175-30		18-5176-30



Eicken - Killian
18-5177-03
3 mm Ø



Killian
18-5178-15
1.5 mm Ø



Ritter - Halle
2.5 mm 18-5179-25
3.0 mm 18-5179-30
4.0 mm 18-5179-40