



- EN** Stomach, Intestine, Rectum
- DE** Magen, Darm, Mastdarm
- ES** Estómago, Intestinos, Recto

Page 483 to 504



EN —● Tissue Seizing and Intestinal Atrauma Tissue Forceps
 DE —● Tissue Beschlagnahme und Darm Atrauma Tissue Zange
 ES —● Aprovechando el tejido intestinal y pinzas de tejido Atrauma



		Allis	
cm	in	4 : 5	5 : 6
15	6"	24-5801-15	24-5802-15
19	7½"		24-5802-19
23	9"		24-5802-23
25	10"		24-5802-25



		Baby-Allis	
24-5803-12	12 cm/4¾"		
24-5803-14	14 cm/5½"		



		Allis-Atrauma	
24-5804-16	16 cm/6¼"		
24-5804-20	20 cm/8"		
24-5804-25	25 cm/10"		
24-5804-30	30 cm/12"		



Allis-Adair
 24-5805-15
 15 cm/6"



Baby-Allis
 24-5806-15
 15 cm/6"



Lockwood-Allis
 24-5807-16 16 cm/6¼"
 24-5807-20 20 cm/8"



Thoms-Allis
 24-5808-20
 20 cm/8"

Tissue Seizing and Intestinal Atrauma Tissue Forceps ● EN
 Tissue Beschlagnahme und Darm Atrauma Tissue Zange ● DE
 Aprovechando el tejido intestinal y pinzas de tejido Atrauma ● ES



Judd-Allis
 24-5809-15 15 cm/6"
 24-5809-19 19 cm/7½"



Littlewood
 24-5810-18
 18.5 cm/7¼"



Williams
 24-5811-16
 16 cm/6¼"



Lockwood
 24-5812-20
 20 cm/8"

Atrauma



cm/in	Babcock-Atrauma
16 cm/6¼"	24-5813-16
18 cm/7"	24-5813-20
20 cm/8"	24-5813-24
24 cm/9½"	



	Babcock(Standard)
	24-5814-16
	24-5814-18
	24-5814-20
	24-5814-24



	Baby-Babcock
	24-5815-16

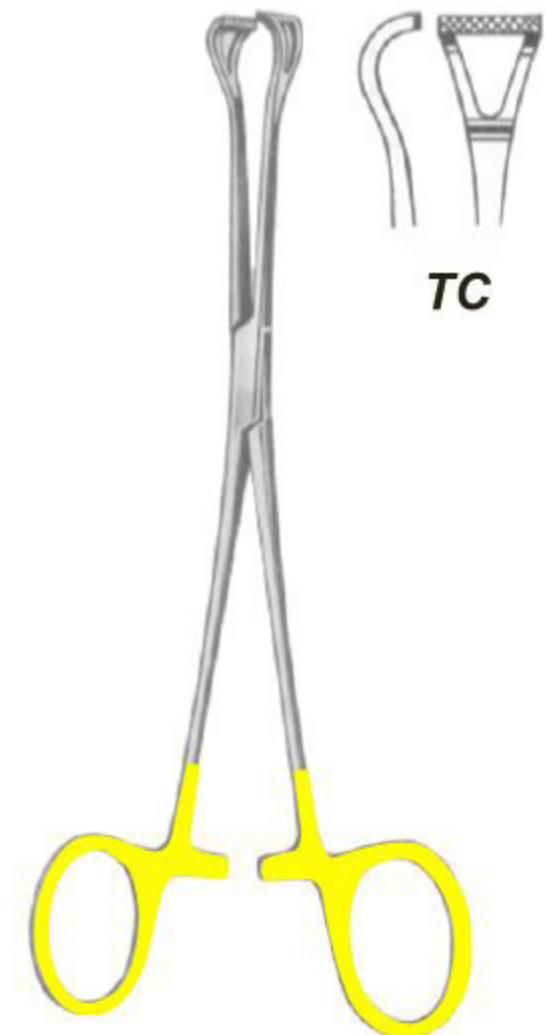

	Babcock
	24-5816-16
	24-5816-20

- EN —● Intestinal Tissue and Organ Grasping Forceps
- DE —● Gewebe- und organ-Faßzangen
- ES —● Pinzas para tejidos y órganos

Atrauma

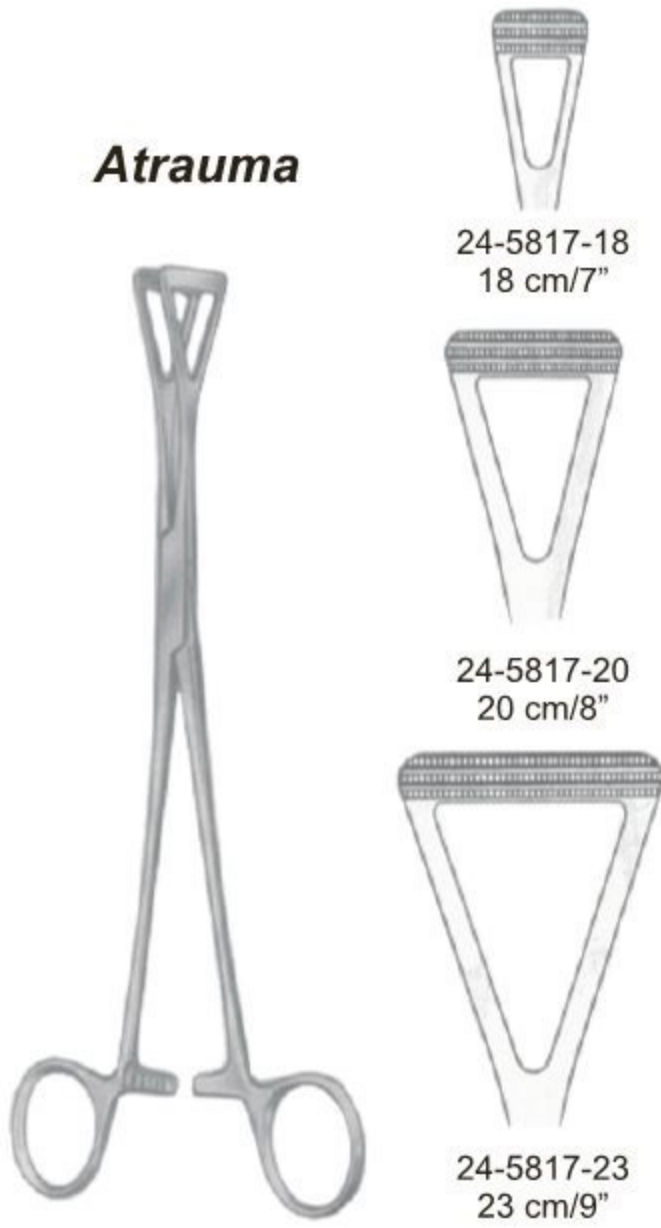

		Duval			
		cm	in		
24-5818-18		18	7"	24-5819-20	
24-5818-20		20	8"	24-5819-23	
24-5818-23		23	9"		

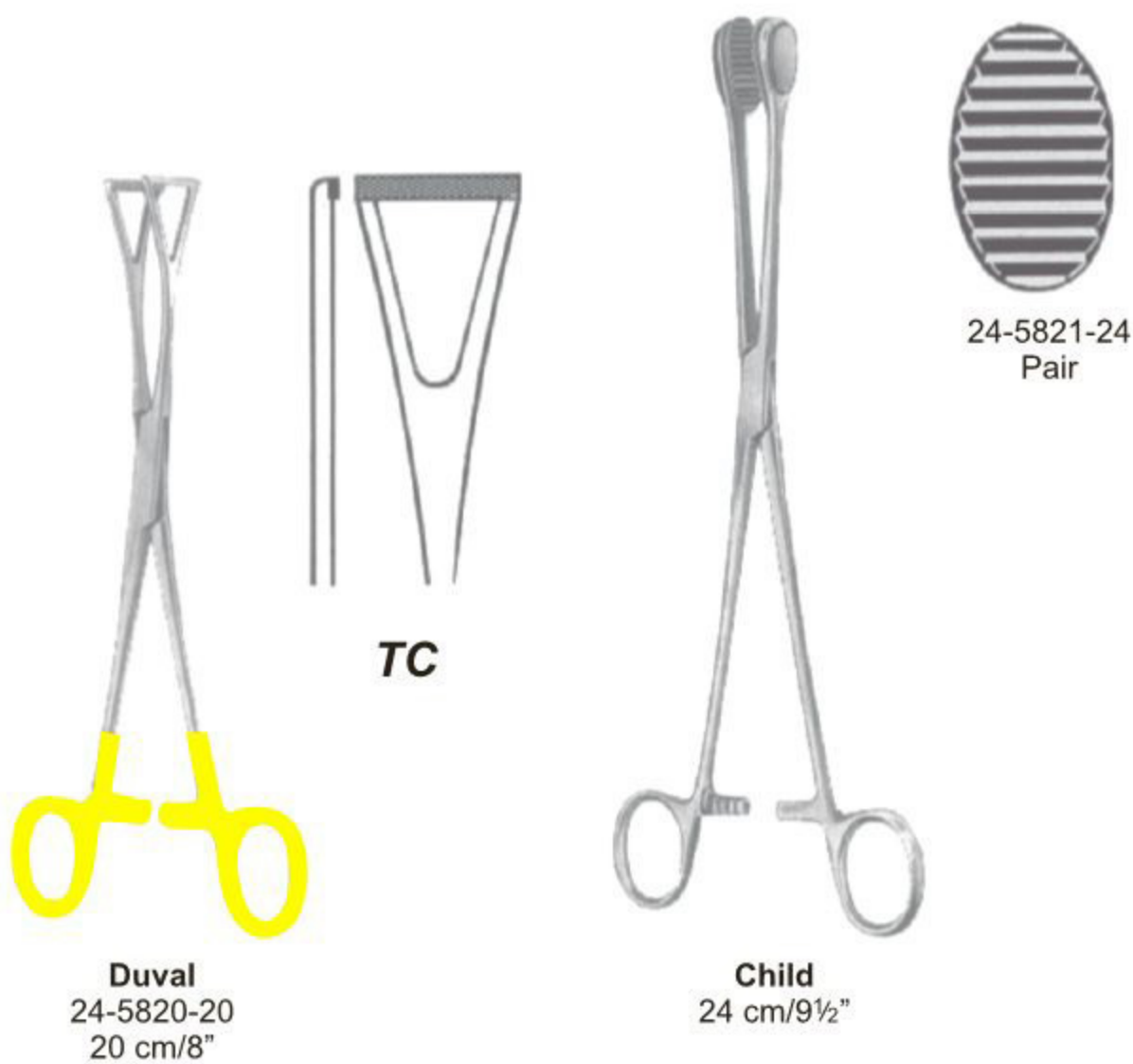

Atrauma

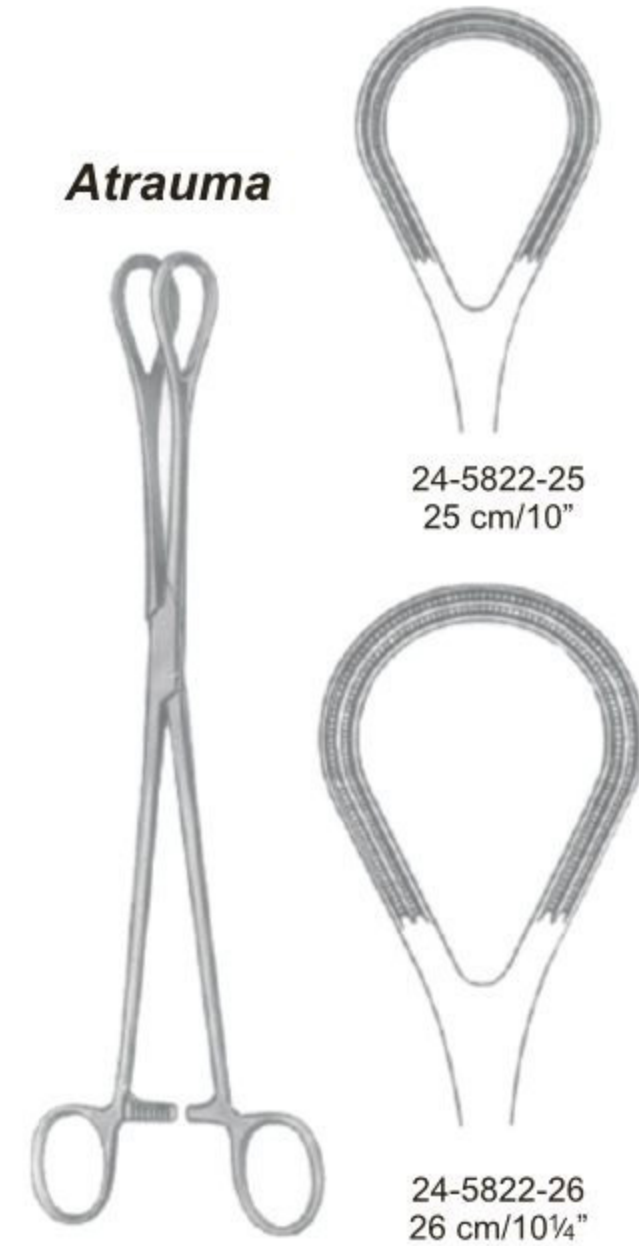

Intestinal Clamps Forceps ●— EN
 Darmklemmen ●— DE
 Pinzas-clamps intestinales ●— ES



Baby-Doyen
 Straight 24-5823-18 18 cm/7"
 Curved 24-5824-18 18 cm/7"

Doyen
 Straight 24-5825-21 21 cm/8 1/4
 24-5825-23 23 cm/9"
 Curved 24-5826-21 21 cm/8 1/4
 24-5826-23 23 cm/9"

Scudder
 24-5827-25 25 cm/10"



Doyen-Atrauma

Atrauma

Straight



Atrauma

Curved

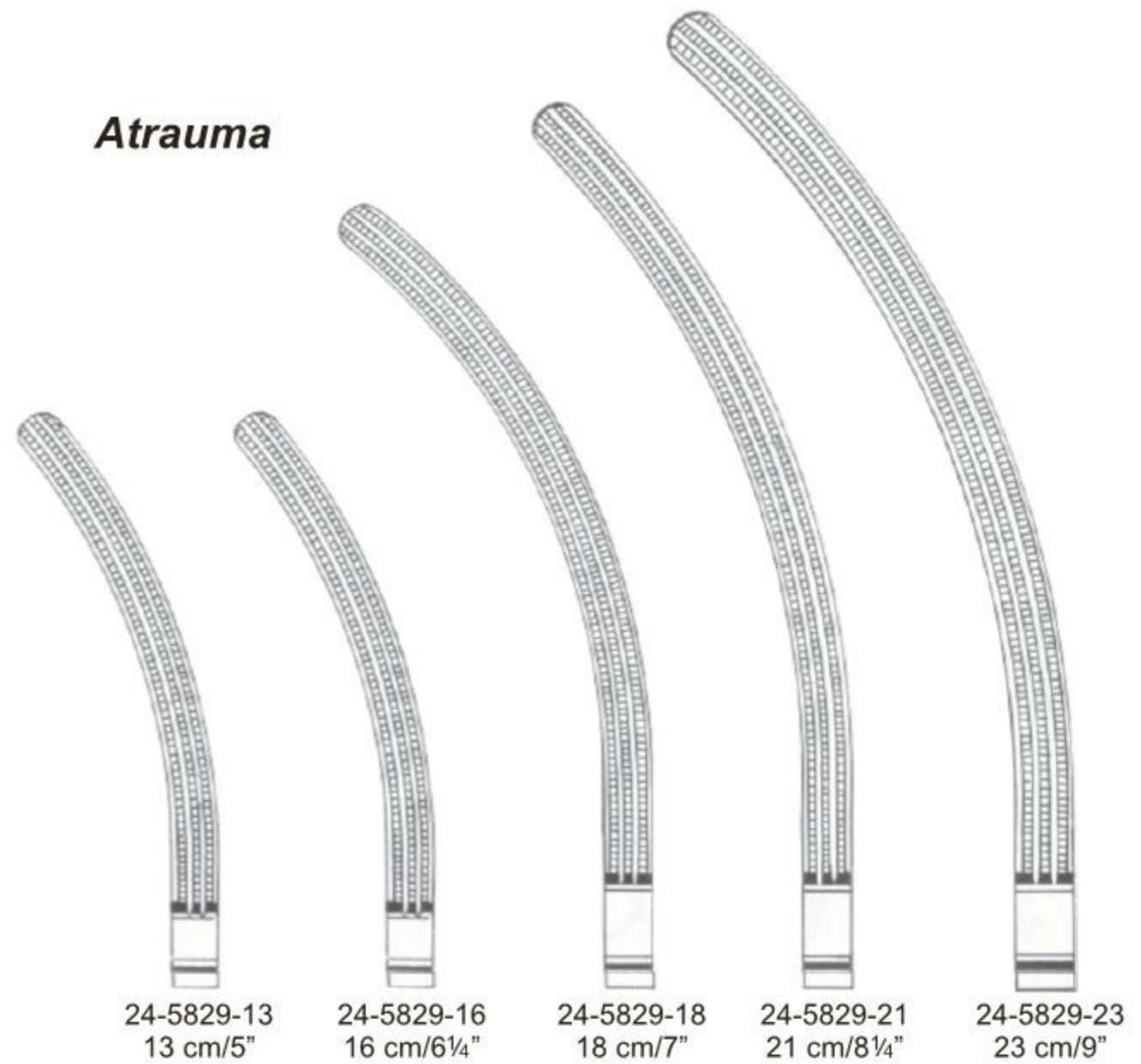

Intestinal Clamps Forceps ●— EN
 Darmklemmen ●— DE
 Pinzas-clamps intestinales ●— ES



Mayo-Robson
 Mayo-Robson Atrauma

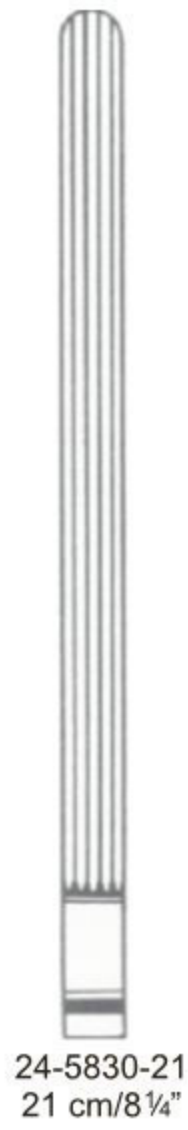

24-5830-21
 21 cm/8 1/4"



24-5831-21
 21 cm/8 1/4"

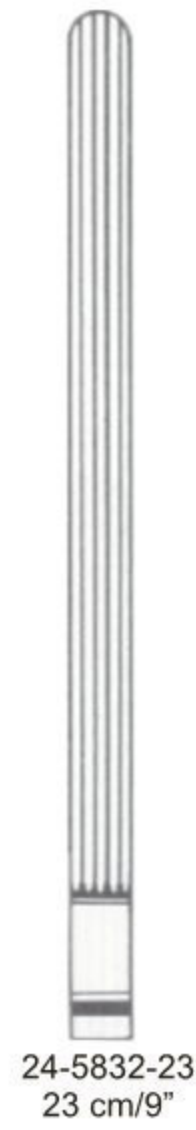

24-5832-23
 23 cm/9"



24-5833-23
 23 cm/9"

Atrauma



24-5834-25
 25 cm/10"



24-5835-25
 25 cm/10"

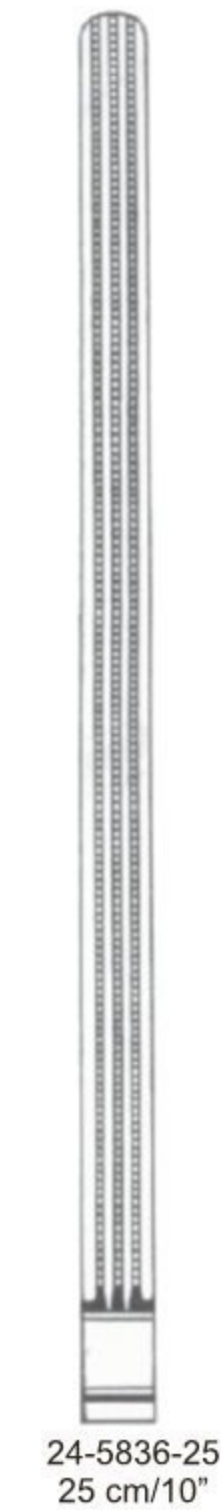

24-5836-25
 25 cm/10"



24-5837-25
 25 cm/10"



Resano
24-5838-30
30 cm/12"



Hayes



24-5839-26
26 cm/10¼"

Atrauma



24-5840-28
28 cm/11"



Fehland
24-5841-24
24 cm/9½"



Brunner
24 cm/9½"



24-5842-24

Atrauma



24-5843-24

Intestinal Clamps Forceps ●— EN
 Darmklemmen ●— DE
 Pinzas-clamps intestinales ●— ES



Straight **Baby-Kocher** Curved
 24-5844-13 24-5845-13
 13 cm/5" 13 cm/5"



Kocher



24-5846-22
22 cm/8¾"



24-5846-25
25 cm/10"



24-5846-28
28 cm/11"



24-5847-22
22 cm/8¾"



24-5847-25
25 cm/10"



24-5847-28
28 cm/11"

Atrauma



Kocher-Atrauma



24-5848-22
22 cm/8 3/4"



24-5848-25
25 cm/10"



24-5848-28
28 cm/11"



24-5849-22
22 cm/8 3/4"



24-5849-25
25 cm/10"



24-5849-28
28 cm/11"

Intestinal Clamps Forceps ●— EN
 Darmklemmen ●— DE
 Pinzas-clamps intestinales ●— ES

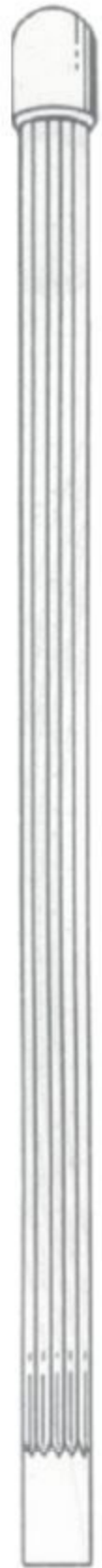

Straight
24-5851-25



Nussbaum
25 cm/10"



Curved
24-5852-25



Pylorus spreader

Benson
24-5850-15
15.5 cm/6"



Allen
24-5853-15 15.5 cm/6"
24-5853-20 20.0 cm/8"



Kleinschmidt
24-5854-12
12 cm/4 3/4"

Blindgut forceps



Payr
(Payr-Baby)

For children



24-5855-15
15 cm/6"

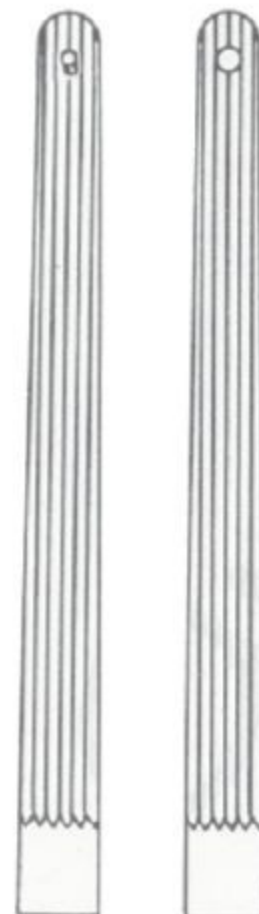

24-5856-21
21 cm/8¼"

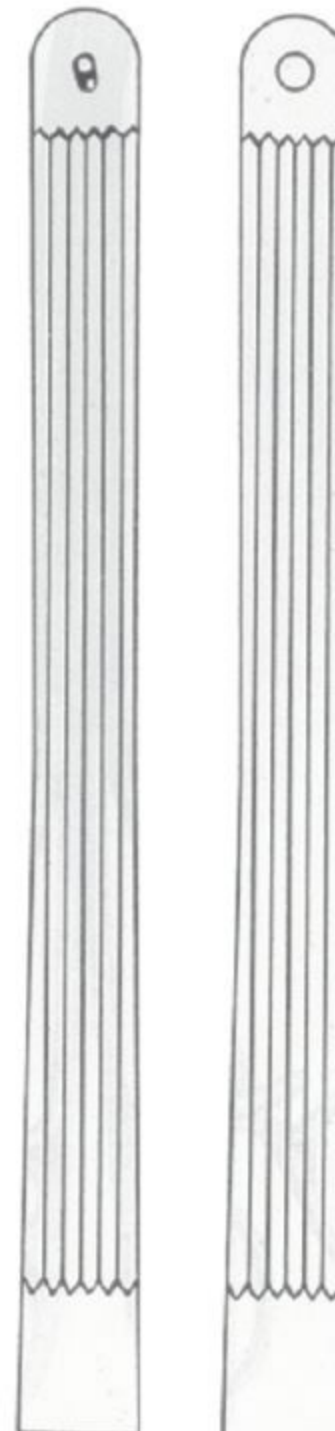

24-5857-29
29 cm/11½"

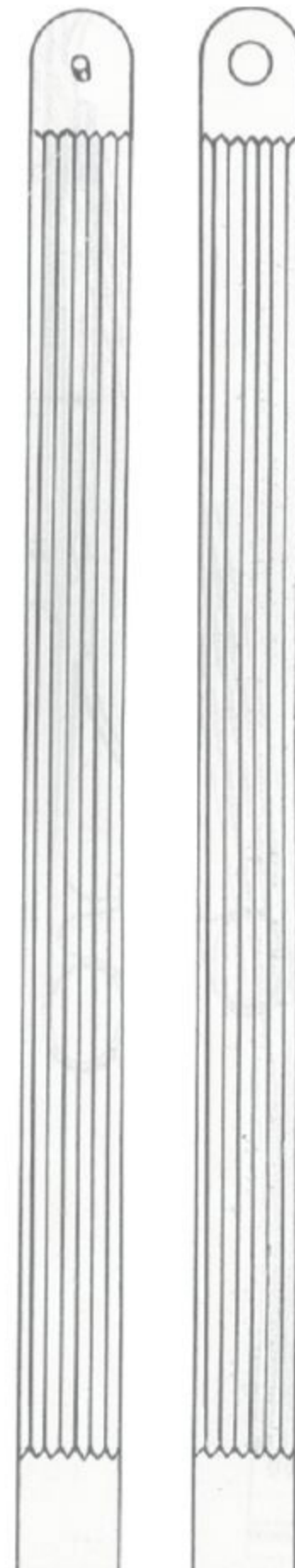

24-5858-35
35 cm/13¾"

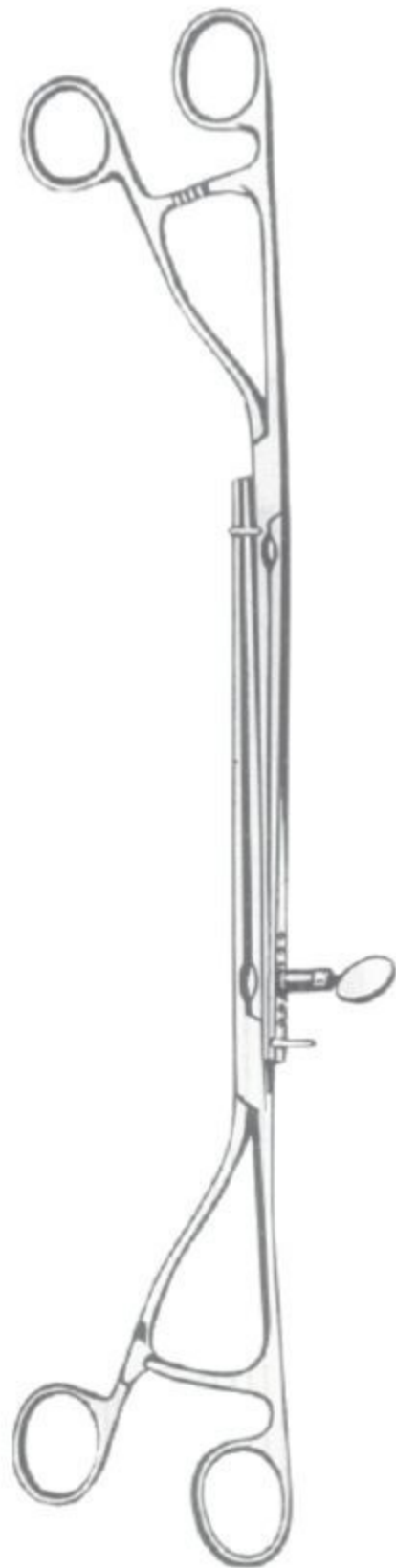

Lane
30 cm/12"

Twin Clamps Forceps



Straight
24-5859-30

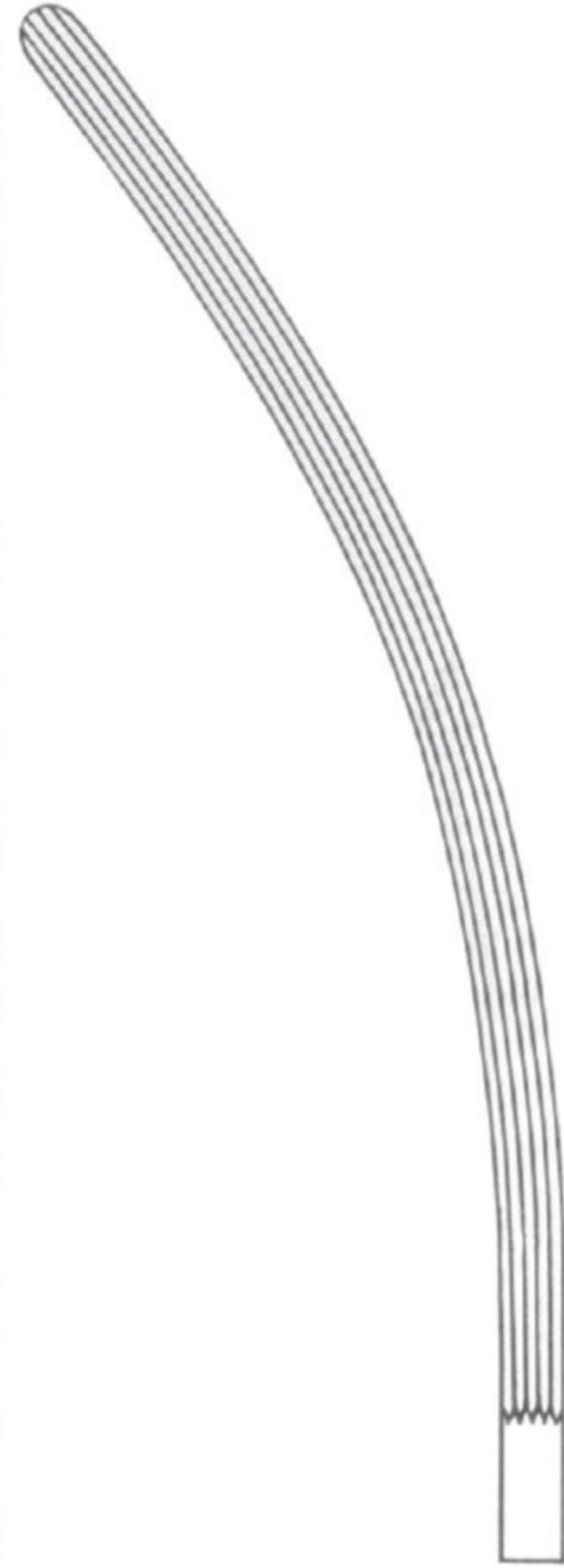

Curved
24-5860-30

Atrauma



Scudder
Scudder-Atraume
 33 cm/13"

Straight
 24-5861-33

Curved
 24-5862-33

Straight
 24-5863-33

Curved
 24-5864-33

Stomach Clamps Forceps ●— EN
 Magenklappen ●— DE
 Pinzas-clamps estomacales ●— ES

Intestinal and Stomach Twin Clamps



Haberer
 24-5865-36
 36 cm/14"



Straight
 24-5866-30

Nussbaum
 30 cm/12"

Curved
 24-5867-30



Czerny
 24-5868-22
 22 cm/8¾"



Pratt
 24-5869-20
 80 x 25 mm
 20.5 cm/8"



Sims
 25-08291-15

**(Bodenhammer)
 Sims**
 24-5870-15
 15 cm/6"

Length of Blades
 24-5871-06 60 mm
 24-5871-08 80 mm
 24-5871-12 125 mm
 24-5871-15 150 mm



Sims
 22 cm/8¾"



Mathieu
 24-5872-19
 90 x 15 mm
 19.5 cm/7¾"

Rectal Speculas, Anal Retractors, Anuscopes ● EN

Mastdarm-spekula, -spreizer, Anoskop ● DE

Espéculos rectales, Anoscopio ● ES



Barr
24-5873-17
17 cm/6¾"
70 X 22 mm

Anal Retractors



Smith-Bule
24-5874-15
15 cm/6"

Anuscopes



Hirschmann
Fig. 1 16 mm Ø x 65 mm 24-5875-01
Fig. 2 19 mm Ø x 65 mm 24-5875-02
Fig. 3 22 mm Ø x 65 mm 24-5875-03
Fig. 4 25 mm Ø x 65 mm 24-5875-04



Bensaude
Fig. 1 19 mm Ø x 70 mm 24-5876-01
Fig. 2 22 mm Ø x 70 mm 24-5876-02

EN —● Anusscopes, Proctoscopes and Sphincteroscopes

DE —● Spinkteroskope, Anuskope, Proktoskope

ES —● Esfinteroscopios, Anoscopios, Proctoscopios

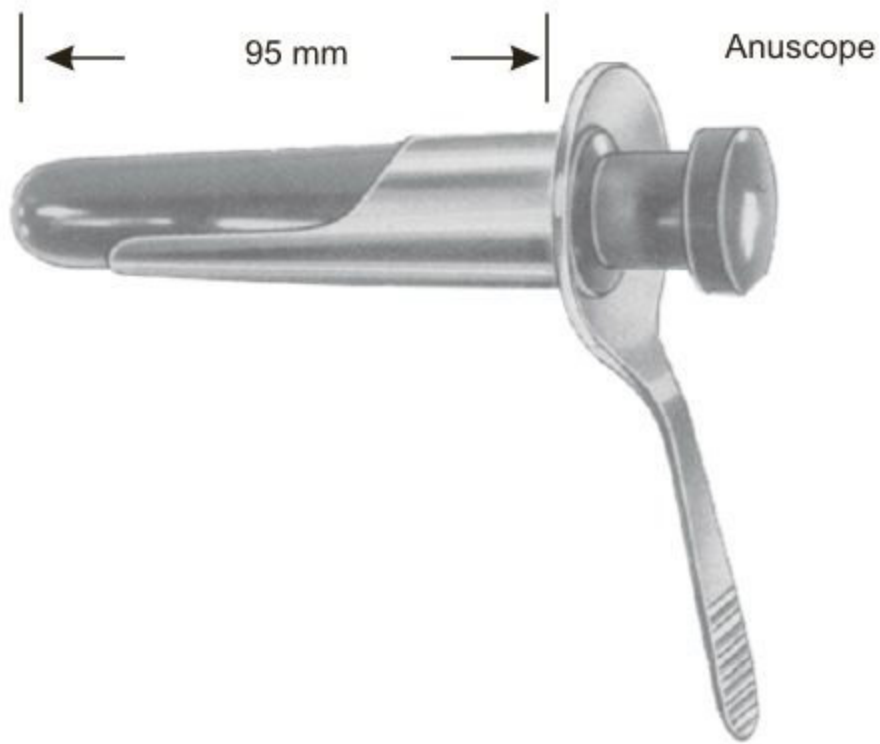

Ives-Fansler
24-5877-22
22 mm Ø

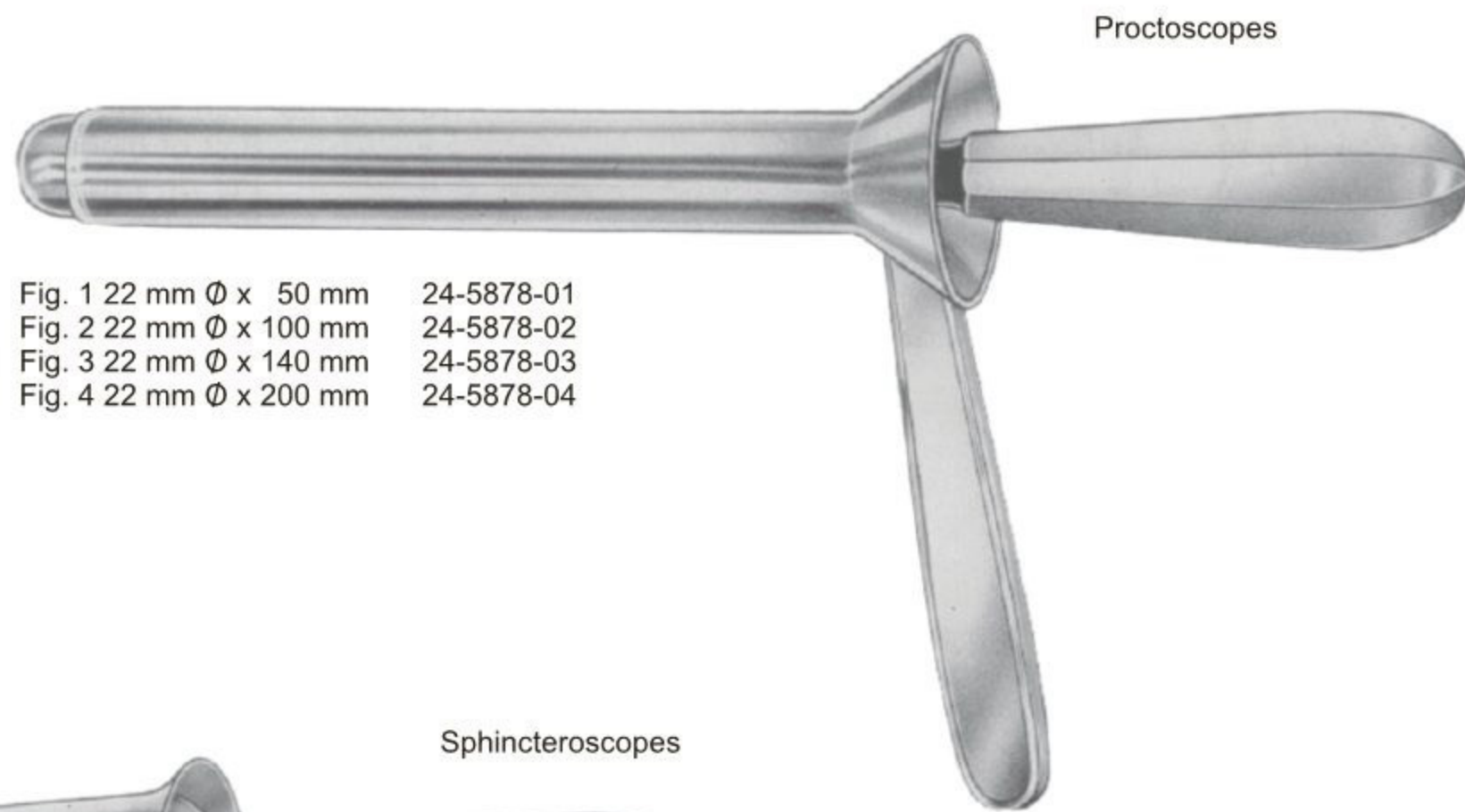
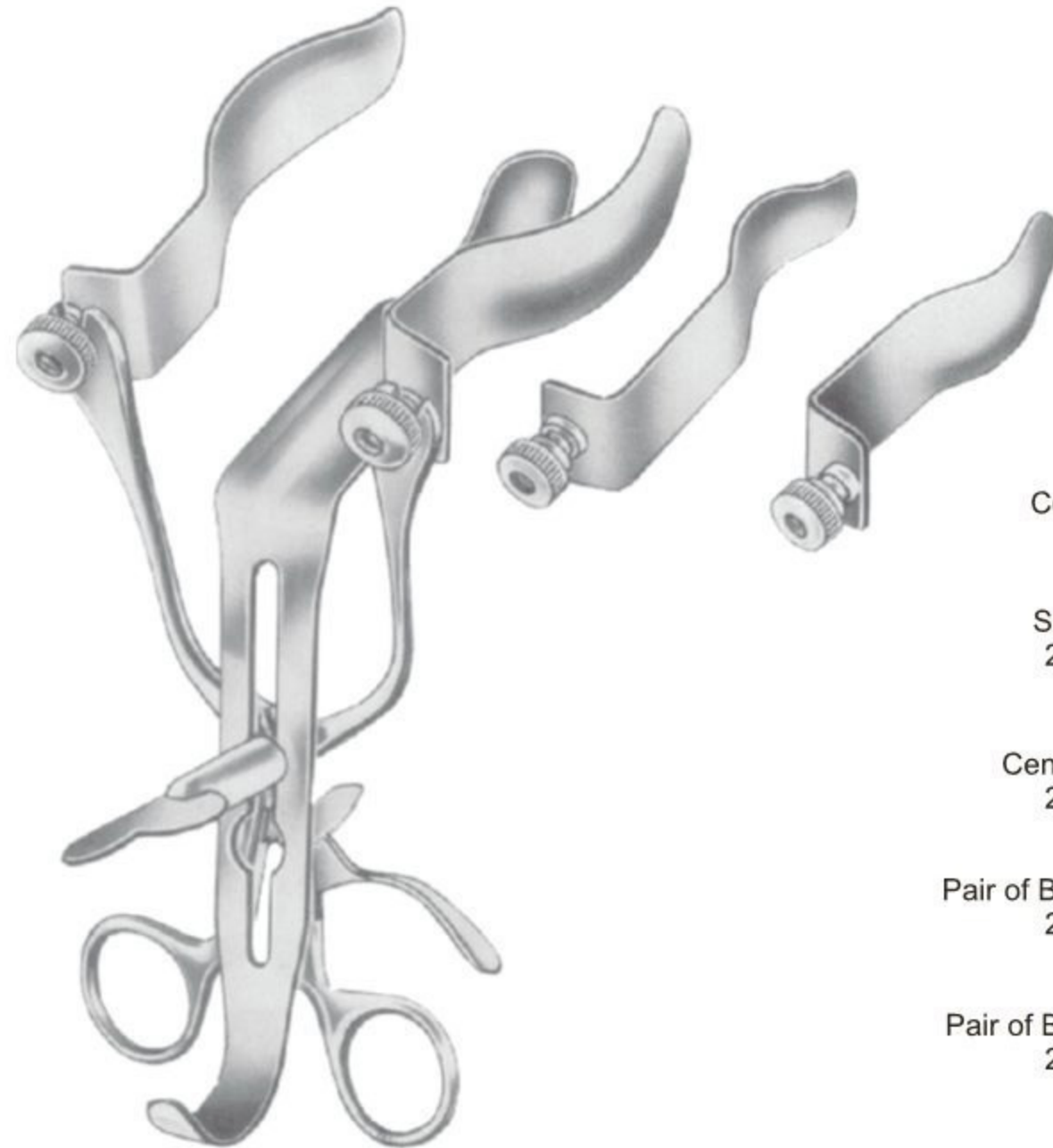

Fig. 1 22 mm Ø x 50 mm 24-5878-01
Fig. 2 22 mm Ø x 100 mm 24-5878-02
Fig. 3 22 mm Ø x 140 mm 24-5878-03
Fig. 4 22 mm Ø x 200 mm 24-5878-04



Kelly
Fig. 1 21 mm Ø 50 mm 24-5879-01
Fig. 2 27 mm Ø 50 mm 24-5879-02



Park
 24-5880-00
 14.5 cm/5¾"

Consisting of:

Spreader only
 24-5880-01

Center Blade only
 24-5880-02

Pair of Blades Only 75 mm
 24-5880-03

Pair of Blades only 95 mm
 24-5880-04



Park
 24-5881-00
 13 cm/5"

Consisting of:

Spreader only
 24-5881-01

Pair of Blades only 95 mm
 24-5881-02

Length of Shaft

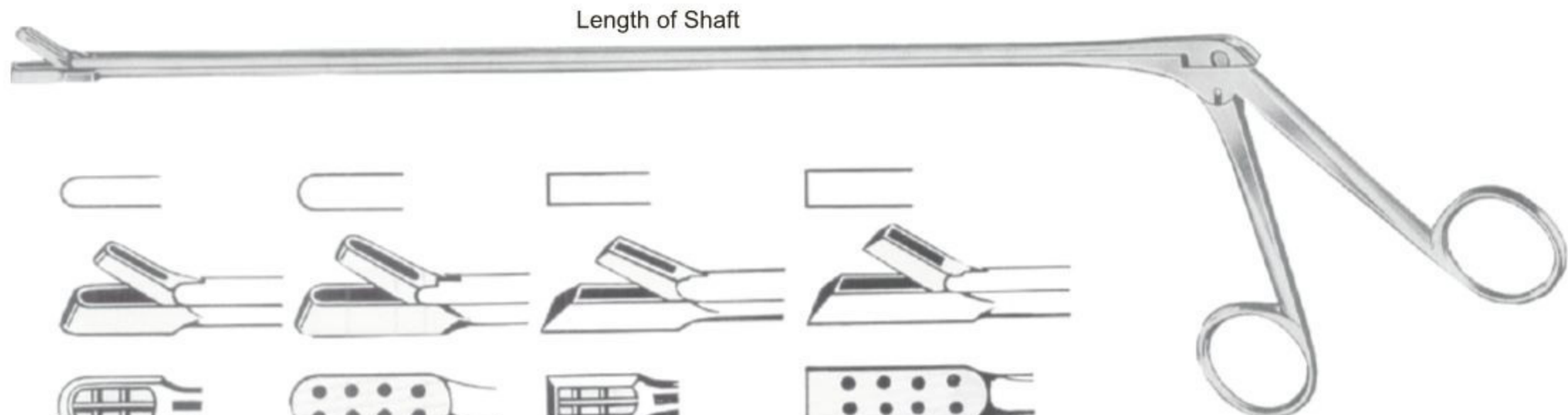



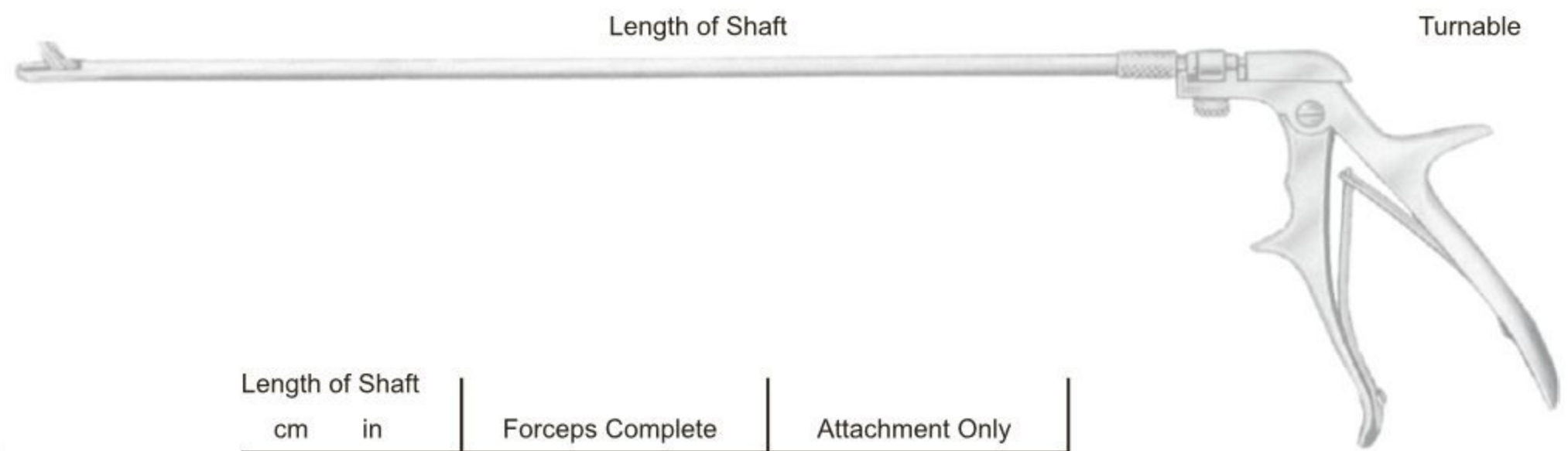

				cm	in	
1	2	3	4			Yeoman
24-5882-28	24-5883-28	24-5884-28	24-5885-28	28	11	
24-5882-35	24-5883-35	24-5884-35	24-5885-35	35	13 ³ / ₄ "	
24-5882-42	24-5883-42	24-5884-42	24-5885-42	42	16 ¹ / ₂ "	

Length of Shaft

Turnable



	Length of Shaft		Forceps Complete	Attachment Only
	cm	in		
	33	13	24-5886-33	24-5890-33
	40	16	24-5886-40	24-5890-40
	33	13	24-5887-33	24-5891-33
	40	16	24-5887-40	24-5891-40
	33	13	24-5888-33	24-5892-33
	40	16	24-5888-40	24-5892-40
	33	13	24-5889-33	24-5893-33
	40	16	24-5889-40	24-5893-40

Yeoman (Turrell)
 Handle Only
 24-5894-00

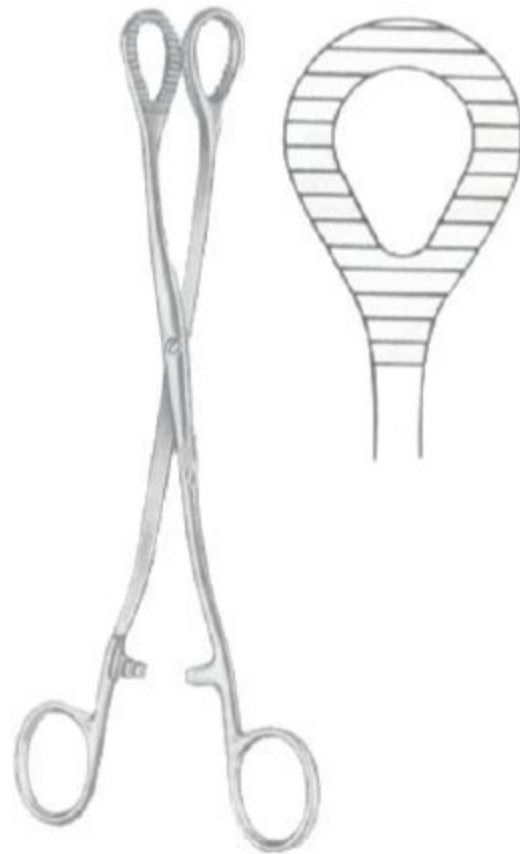

Heywood-Smith
 24-5895-21
 21 cm/8¼"



Heywood-Smith
 24-5896-21
 21 cm/8¼"

Rectal Snare

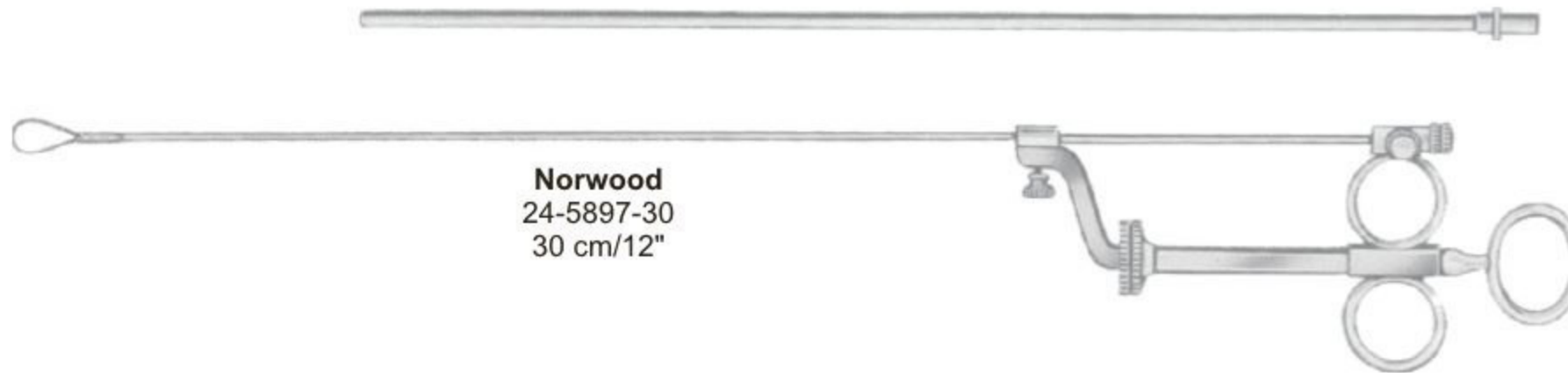

Norwood
 24-5897-30
 30 cm/12"

Rectal Aspiration Cannula



Buie
 24-5898-40
 Charr. 10. 40 cm/15¾"

Rectal Coolers



24-5899-01

24-5900-02

Aspiration Tip

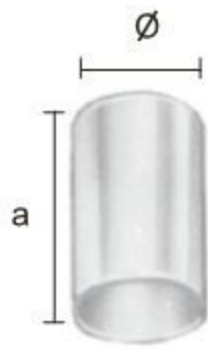

	a	∅
24-5901-11	11 mm	10 mm
24-5901-16	16 mm	10 mm

Charging Cone



10 mm ∅

24-5902-10

Charging Cone



12 mm ∅

24-5903-12

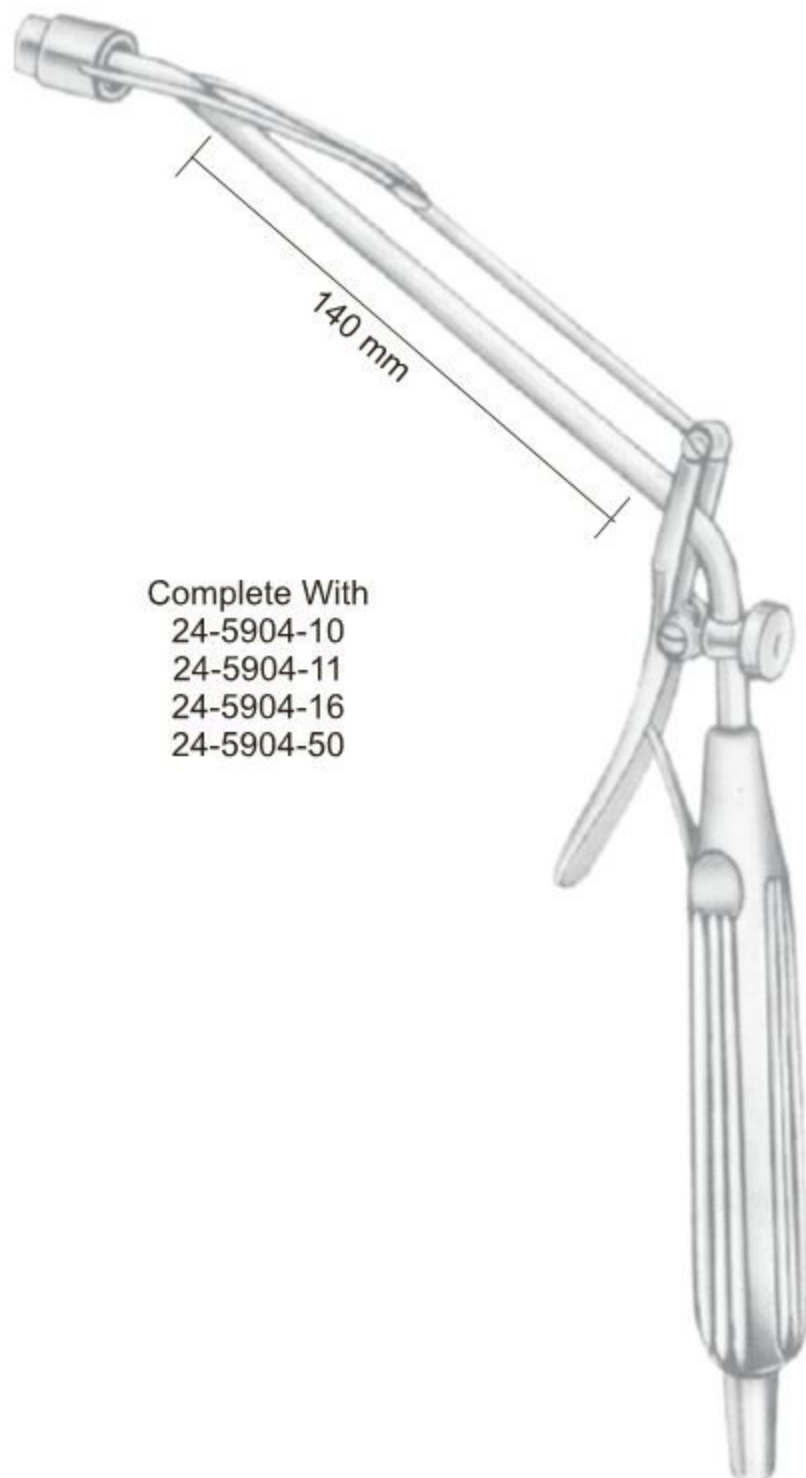

Complete With
 24-5904-10
 24-5904-11
 24-5904-16
 24-5904-50



Complete With
 24-5905-00
 24-5906-12
 24-5907-50

Rudd
 31.5 cm/12½"

Haemorrhoidal Ligators ●— EN
 Haemorrhoidal Ligators ●— DE
 Ligators Haemorrhoidal ●— ES

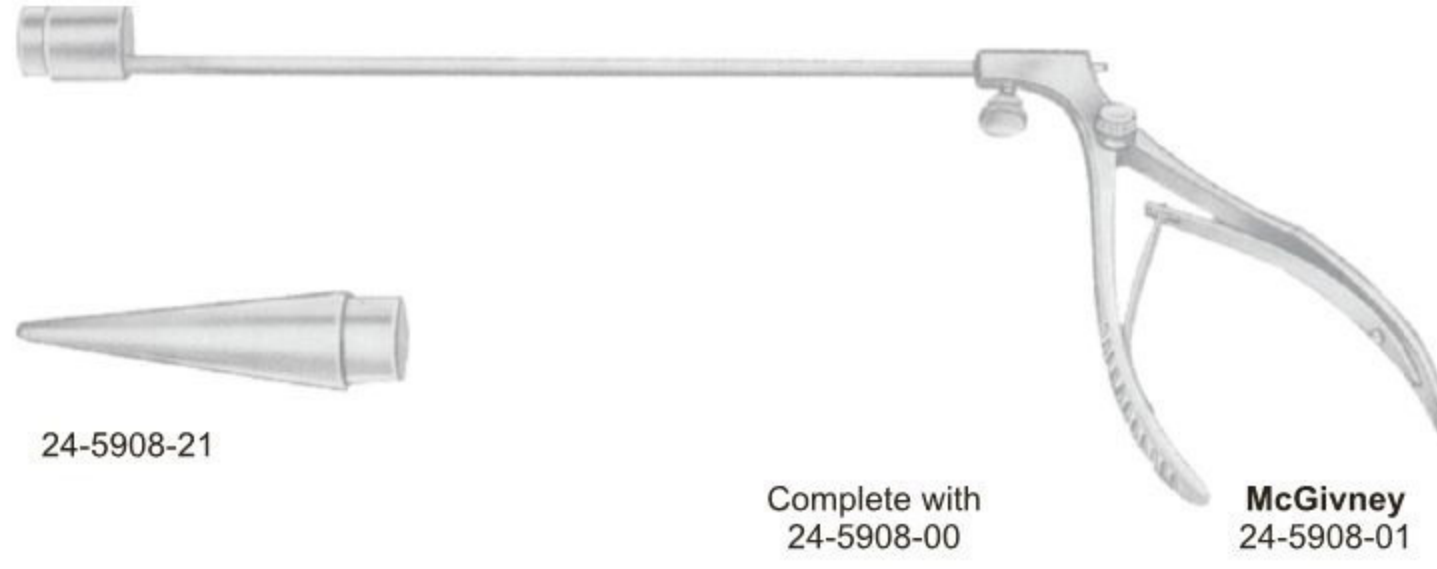

24-5908-21

Complete with
24-5908-00

McGivney
24-5908-01

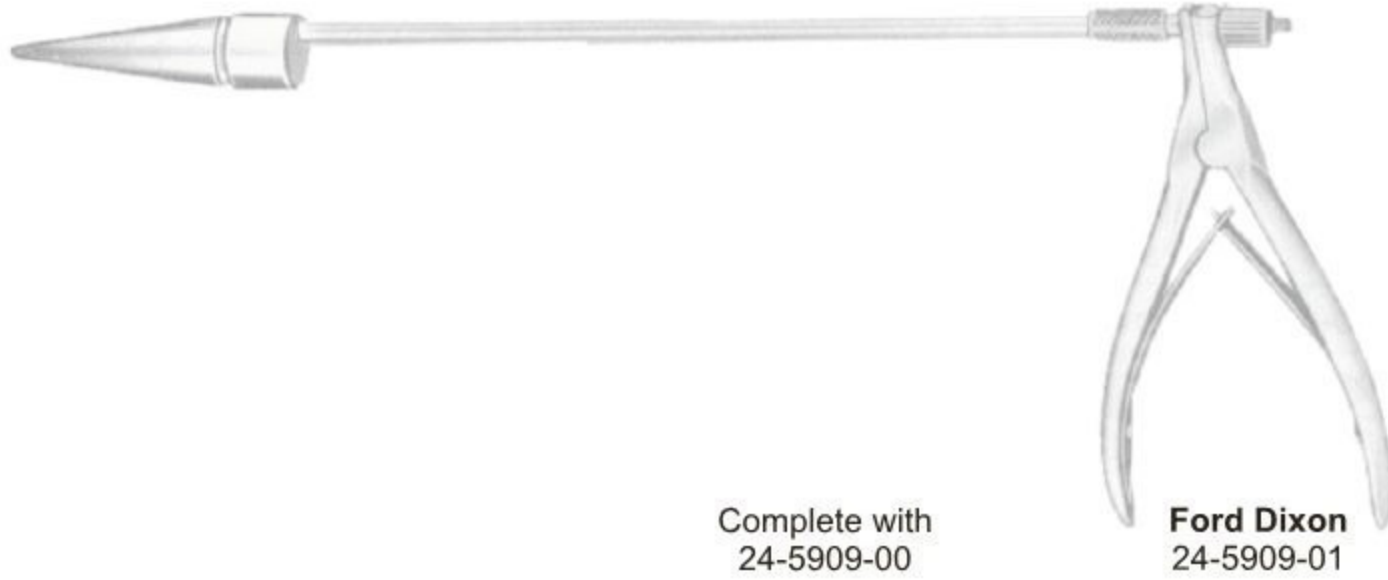

Complete with
24-5909-00

Ford Dixon
24-5909-01



Complete with
24-5911-00

24-5911-01



McGivney
24-5910-19
19 cm/7 1/2"



24-5912-00
Ligator rubber rings
in box of 100 pieces