



- EN** Gynecology
- DE** Gynäkologie
- ES** Ginecología

Page 519 to 558



Scheme of Dimensions for Specula

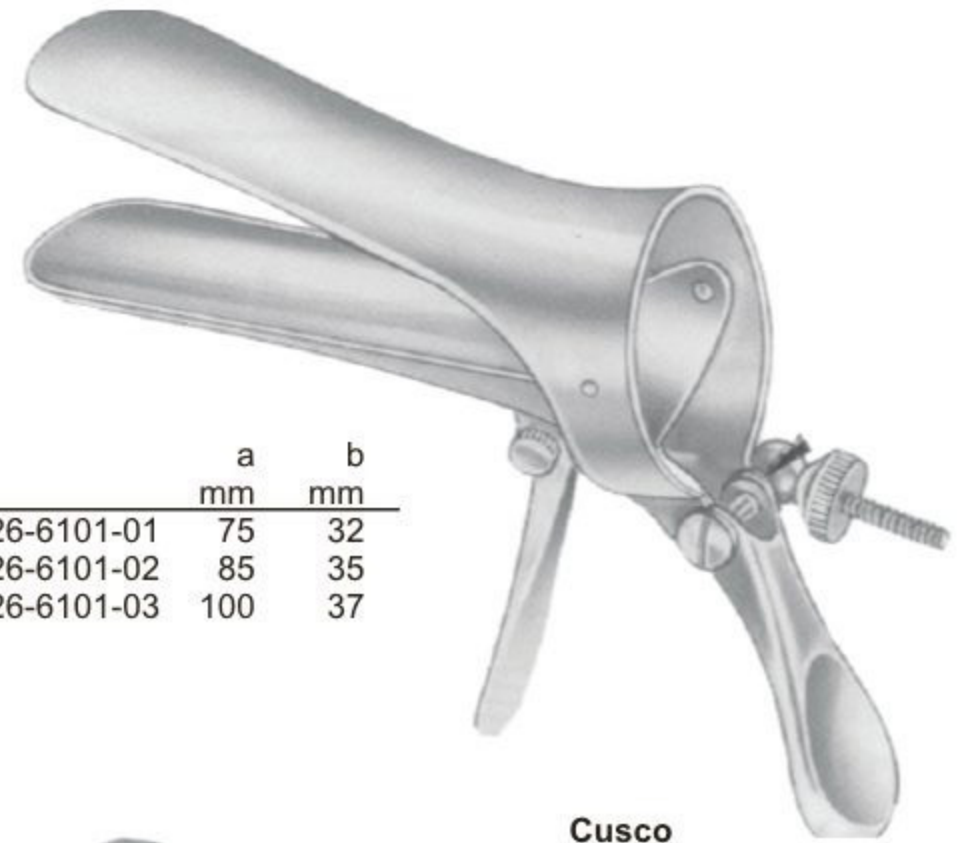
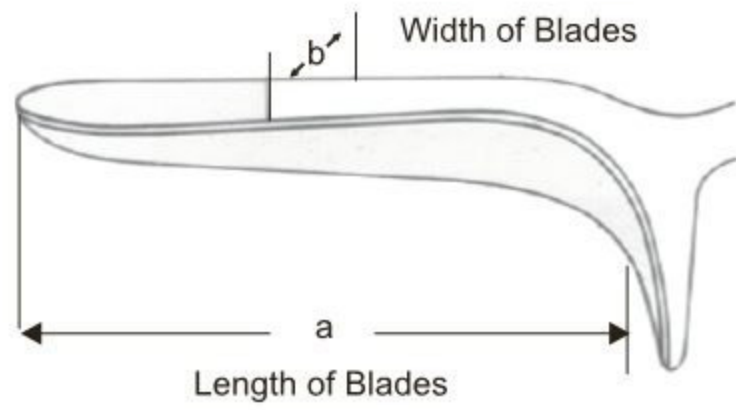

	a mm	b mm
26-6101-01	75	32
26-6101-02	85	35
26-6101-03	100	37

Cusco

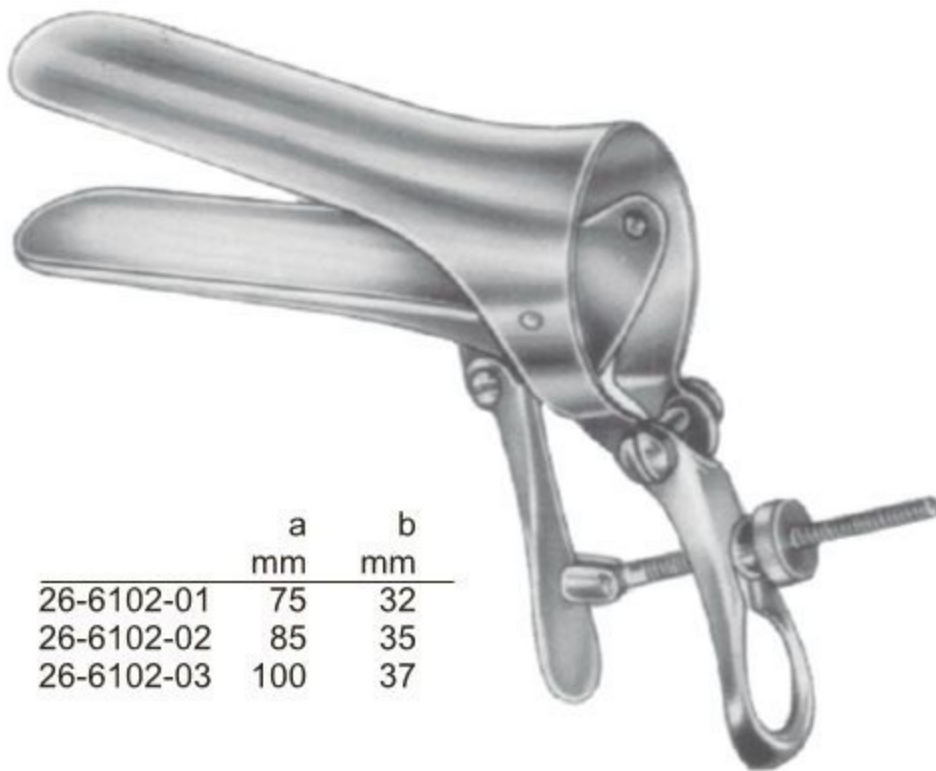

	a mm	b mm
26-6102-01	75	32
26-6102-02	85	35
26-6102-03	100	37

Cusco



For Virgins	a mm	b mm
26-6103-00	75	17

Cusco

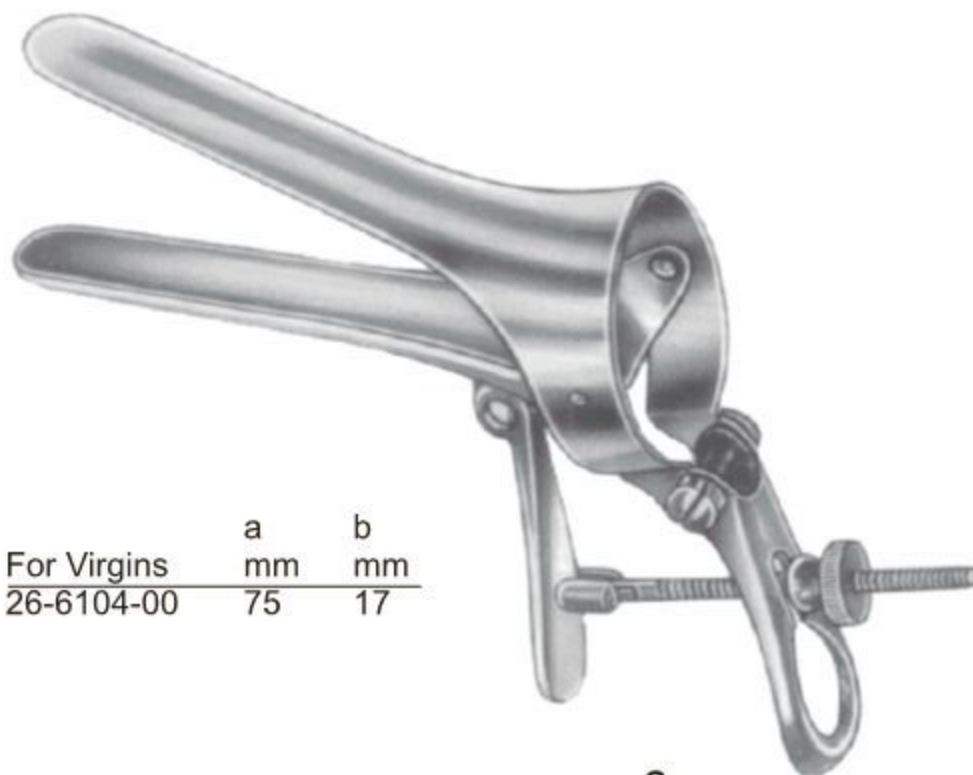

For Virgins	a mm	b mm
26-6104-00	75	17

Cusco



	a mm	b mm
26-6105-01	90	23-25
26-6105-02	100	25-27
26-6105-03	110	27-30

Cusco
Swiss Pattern

Vaginal Speculas ● EN
 Scheidenspekula ● DE
 Espéculos vaginales ● ES

**Collin-Landau**

Small	26-6106-01	30 x 85 mm
Medium	26-6106-02	35 x 100 mm
Large	26-6106-03	40 x 110 mm

**Collin**

Small	26-6107-01	30 x 85 mm
Medium	26-6107-02	35 x 100 mm
Large	26-6107-03	40 x 110 mm

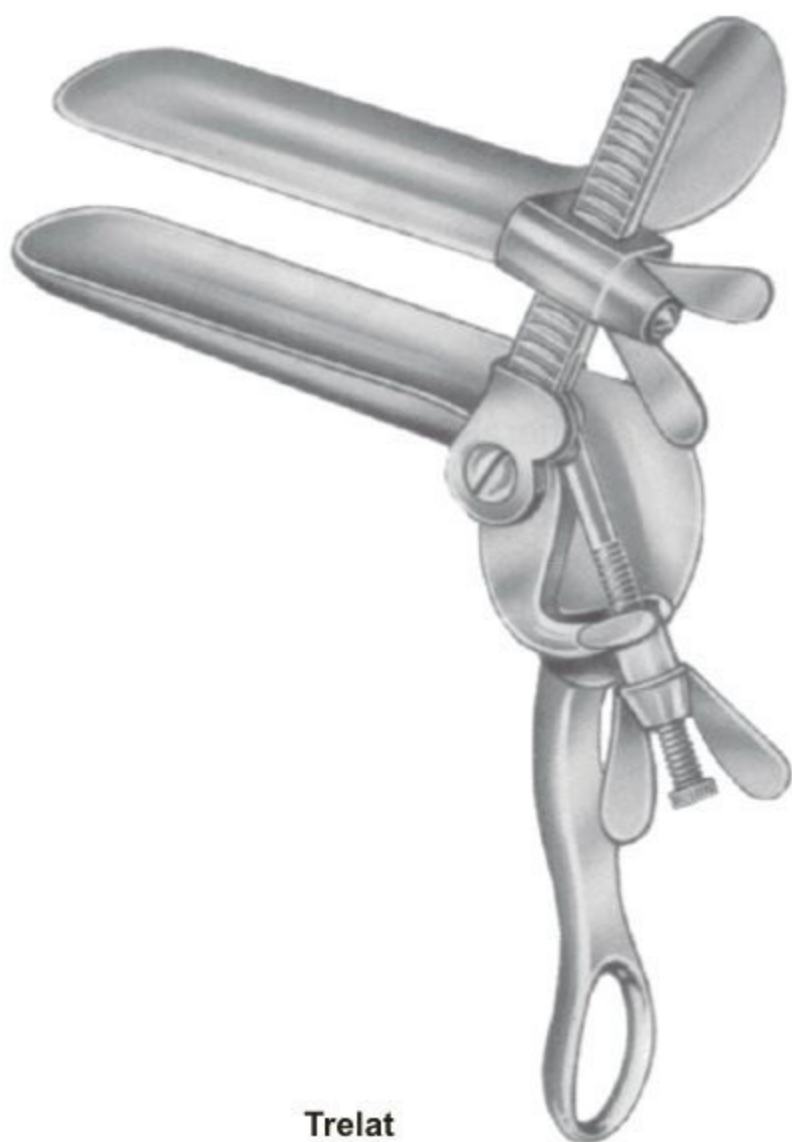
**Trelat**

	a	b
	mm	mm
26-6108-01	85	33
26-6108-02	95	35
26-6108-03	115	43

**Grave (Standard)**

	a	b
	mm	mm
26-6109-01	75	20
26-6109-02	95	30
26-6109-03	115	35
26-6109-04	125	35

- EN —● Vaginal Speculas
- DE —● Scheidenspekula
- ES —● Espéculos vaginales

Black



Grave	a mm	b mm
26-6110-01	75	20
26-6110-02	95	35
26-6110-03	115	35



Grave	a mm	b mm
Angled 135° 26-6111-00	101	35

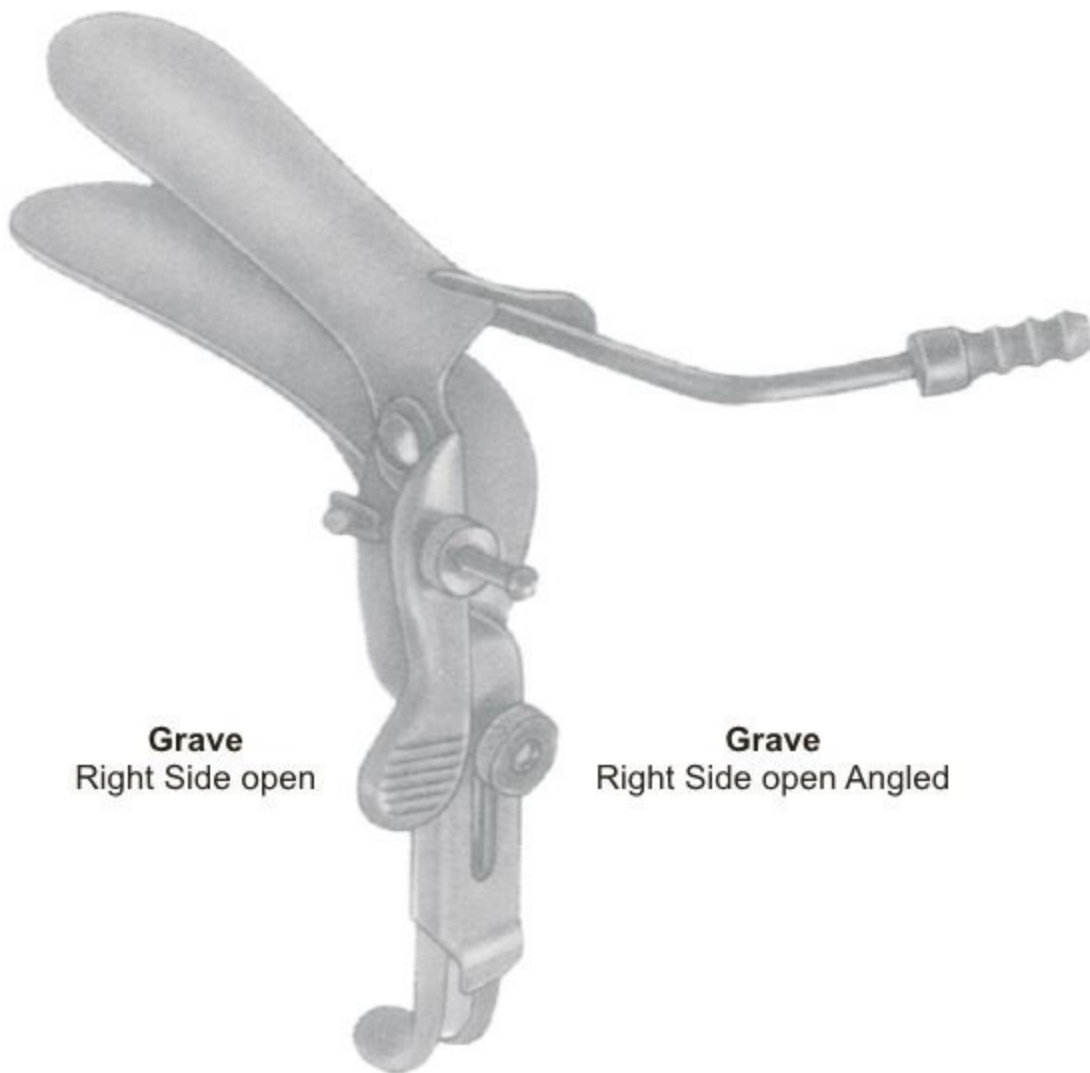

Grave
Right Side open

Grave
Right Side open Angled

	a mm	b mm
26-6112-01	101	35
26-6112-02	101	35

Lateral Specula



26-6113-00



Pederson

	a mm	b mm
26-6114-01	75	13
26-6114-02	100	22
26-6114-03	120	25



Semm

	a mm	b mm
26-6115-01	90	14/18
26-6115-02	100	17/20
26-6115-03	100	25/30



Nott

	a mm	b mm
26-6116-01	90	30
26-6116-02	110	30

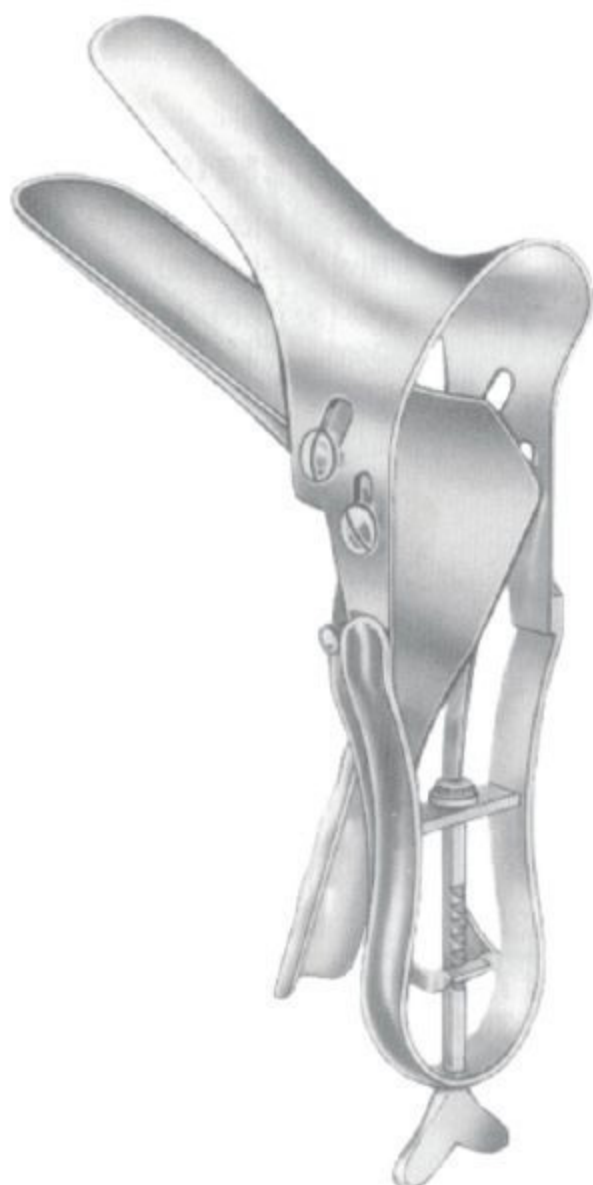

Seyffert

	a mm	b mm
26-6117-01	100	17
26-6117-02	110	33



Seyffert

	a mm	b mm
26-6118-02	110	33

One Side open

- EN —● Vaginal Speculas
- DE —● Scheidenspekula
- ES —● Espéculos vaginales

Scheme of Dimensions for Specula

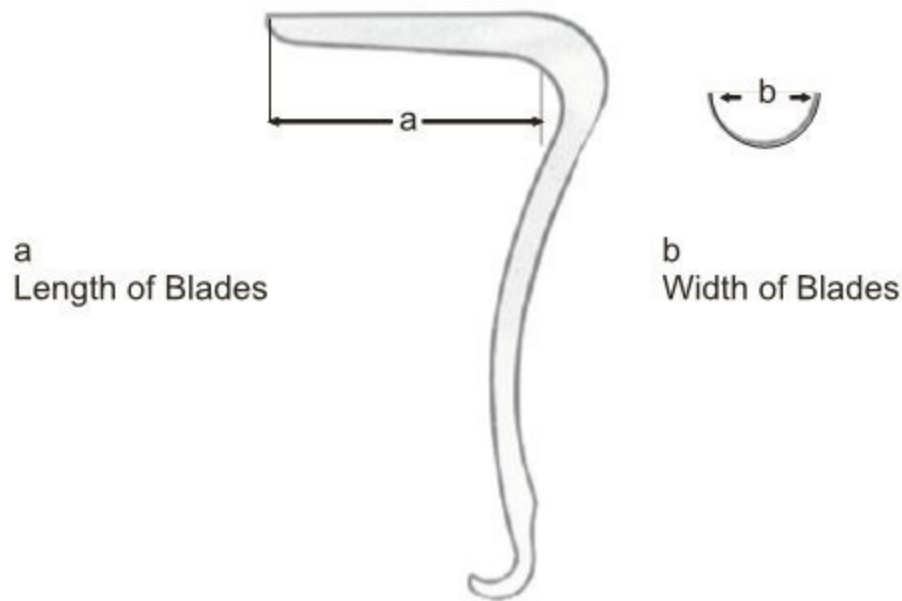

Sims (single ended)

26-6119-01	63 x 32 mm
26-6119-02	76 x 32 mm
26-6119-03	89 x 38 mm



Sims (double ended)

26-6120-01	26 x 70 mm (30 x 75 mm)
26-6120-02	30 x 75 mm (35 x 80 mm)
26-6120-03	36 x 80 mm (40 x 90 mm)



Jackson

	Fig.	a mm	b mm
26-6121-01	1	75 X 40	
26-6121-02	2	90 X 40	
26-6121-03	3	100 X 40	



Eastman

	Fig.	a mm	b mm
26-6122-01	1	76	38
26-6122-02	2	89	38
26-6122-03	3	101	38

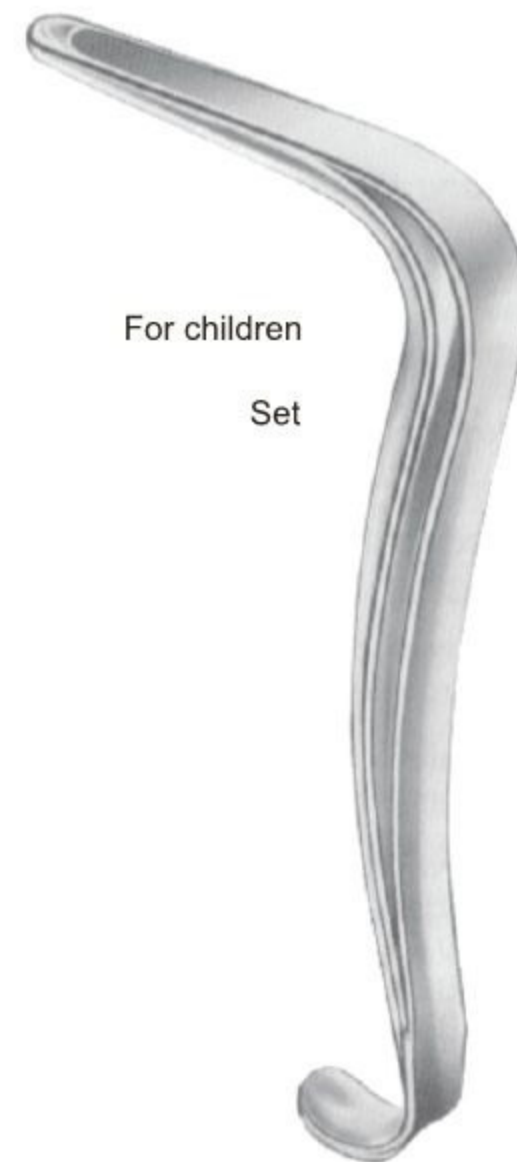

For children

Set

Kristeller

26-6123-00
70x15 mm

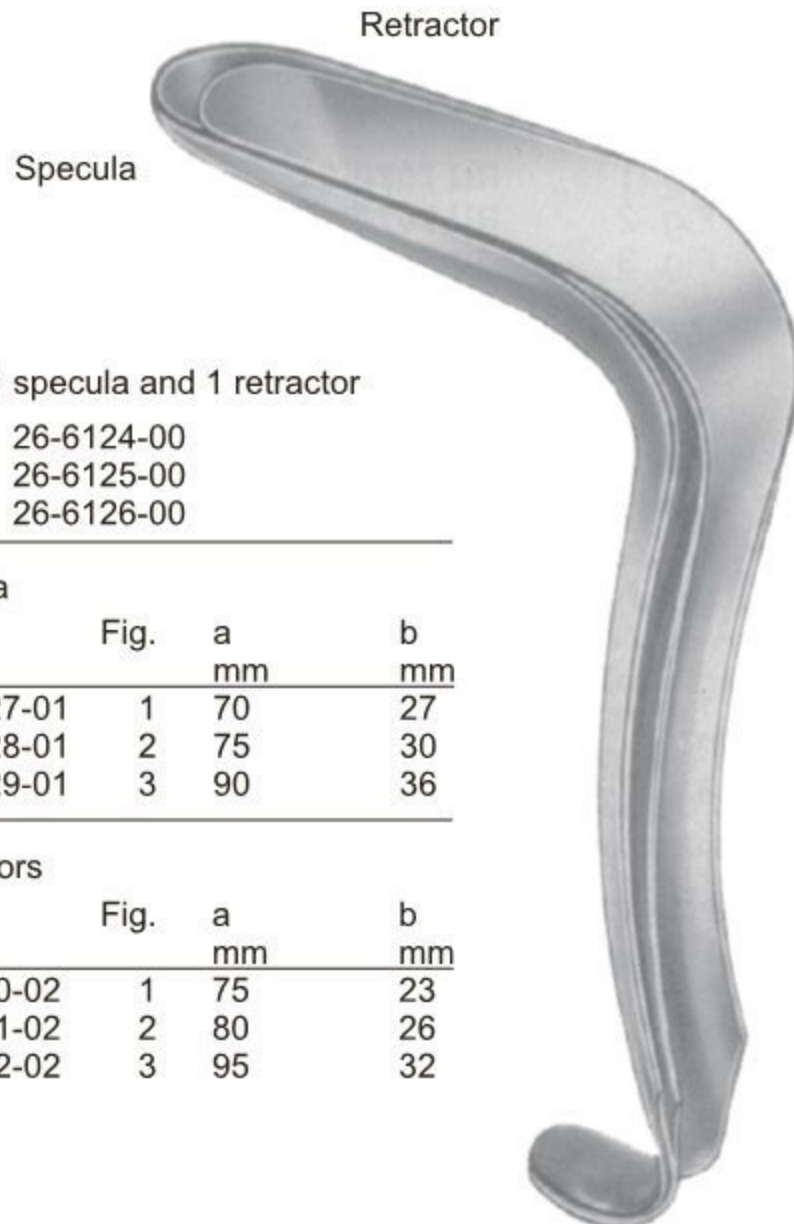

Set of 1 specula and 1 retractor

- Fig. 1 26-6124-00
- Fig. 2 26-6125-00
- Fig. 3 26-6126-00

Specula

	Fig.	a mm	b mm
26-6127-01	1	70	27
26-6128-01	2	75	30
26-6129-01	3	90	36

Retractors

	Fig.	a mm	b mm
26-6130-02	1	75	23
26-6131-02	2	80	26
26-6132-02	3	95	32

**Kristeller
(Standard)**

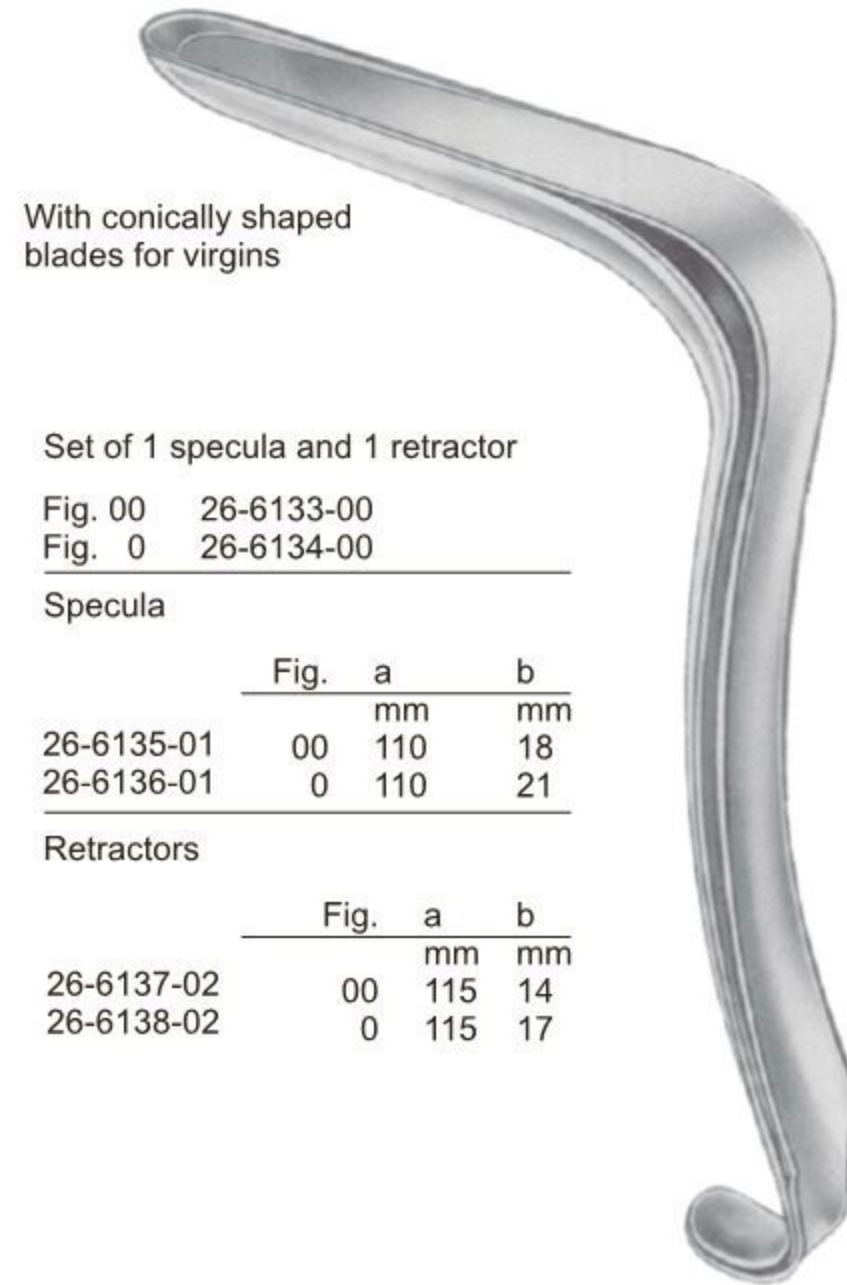

With conically shaped blades for virgins

Set of 1 specula and 1 retractor

- Fig. 00 26-6133-00
- Fig. 0 26-6134-00

Specula

	Fig.	a mm	b mm
26-6135-01	00	110	18
26-6136-01	0	110	21

Retractors

	Fig.	a mm	b mm
26-6137-02	00	115	14
26-6138-02	0	115	17

Kristeller

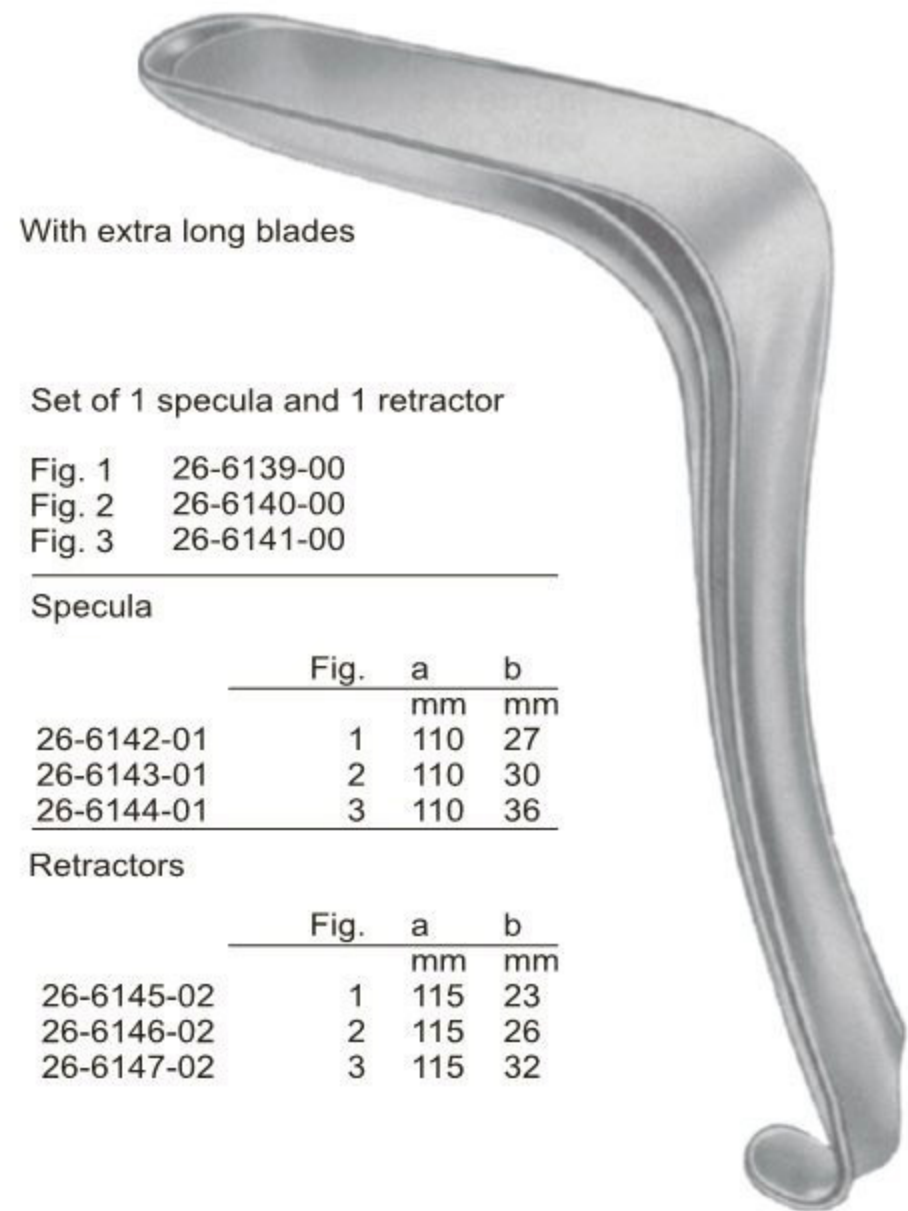

With extra long blades

Set of 1 specula and 1 retractor

- Fig. 1 26-6139-00
- Fig. 2 26-6140-00
- Fig. 3 26-6141-00

Specula

	Fig.	a mm	b mm
26-6142-01	1	110	27
26-6143-01	2	110	30
26-6144-01	3	110	36

Retractors

	Fig.	a mm	b mm
26-6145-02	1	115	23
26-6146-02	2	115	26
26-6147-02	3	115	32

**Kristeller
(Standard)**

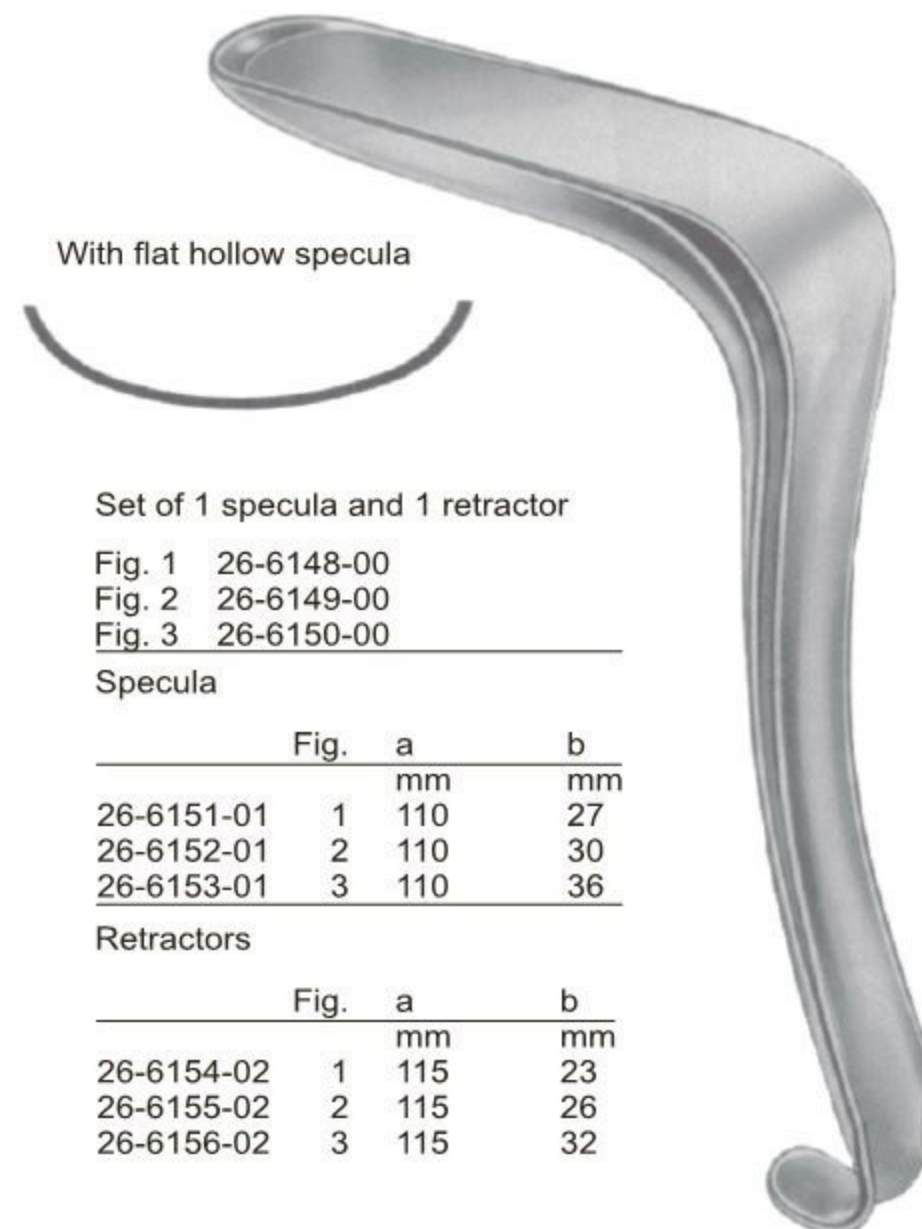

With flat hollow specula

Set of 1 specula and 1 retractor

- Fig. 1 26-6148-00
- Fig. 2 26-6149-00
- Fig. 3 26-6150-00

Specula

	Fig.	a mm	b mm
26-6151-01	1	110	27
26-6152-01	2	110	30
26-6153-01	3	110	36

Retractors

	Fig.	a mm	b mm
26-6154-02	1	115	23
26-6155-02	2	115	26
26-6156-02	3	115	32

Kristeller

EN —● Vaginal Speculas and Retractors
 DE —● Scheidenspekula und -halter
 ES —● Espéculos y Valvas vaginales

	a mm	b mm
26-6157-20	100	20
26-6157-25	100	25
26-6157-30	100	30
26-6157-35	100	35
26-6157-40	100	40
26-6158-20	130	20
26-6158-25	130	25
26-6158-30	130	30
26-6158-35	130	35
26-6158-40	130	40

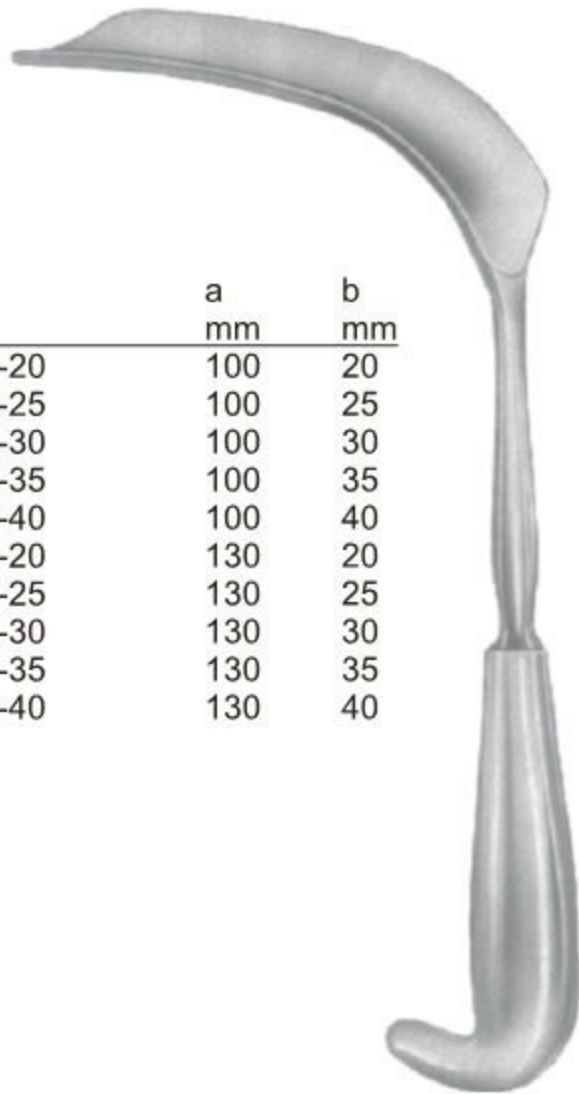

Matzenauer



Braun
 26-6159-18
 18 cm/7"
 56x13 mm



Braun
 26-6160-18
 18 cm/7"
 60x10 mm



Ulrich
 26-6161-19
 19.5 cm/7½"
 80x20 mm



26-6162-19
 19 cm/7½"
 85x17 mm

Set

26-6163-00	Fig. 1
26-6164-00	Fig. 2

Specula

	Fig.	a mm	b mm
26-6165-01	1	70	40
26-6166-01	2	90	40

Retractors

	Fig.	a mm	b mm
26-6167-02	1	70	33
26-6168-02	2	90	33

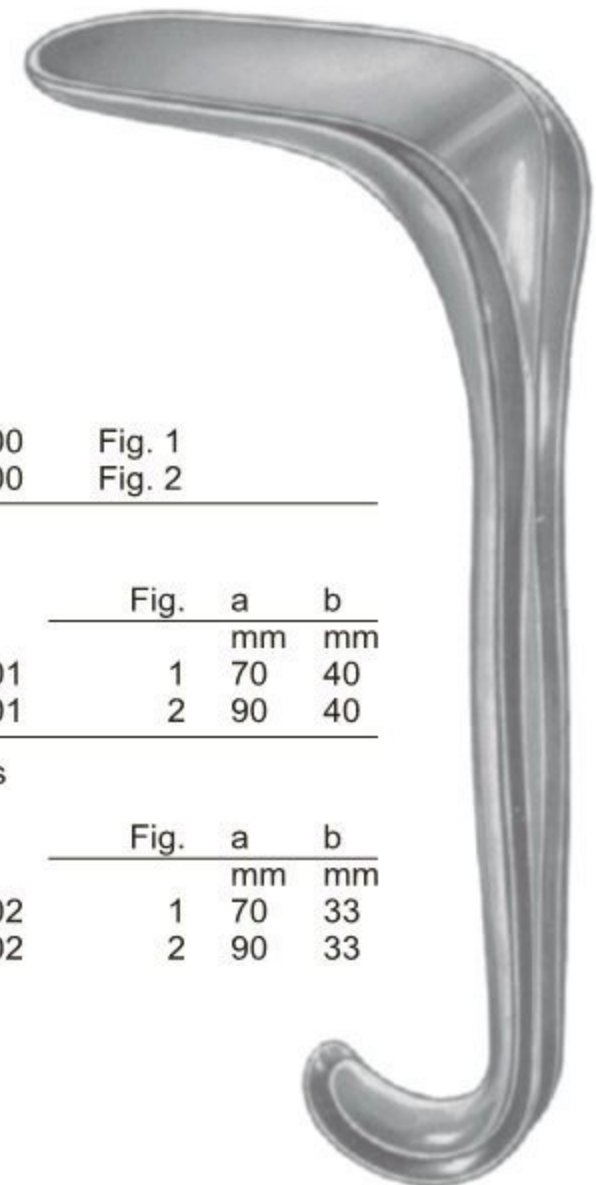

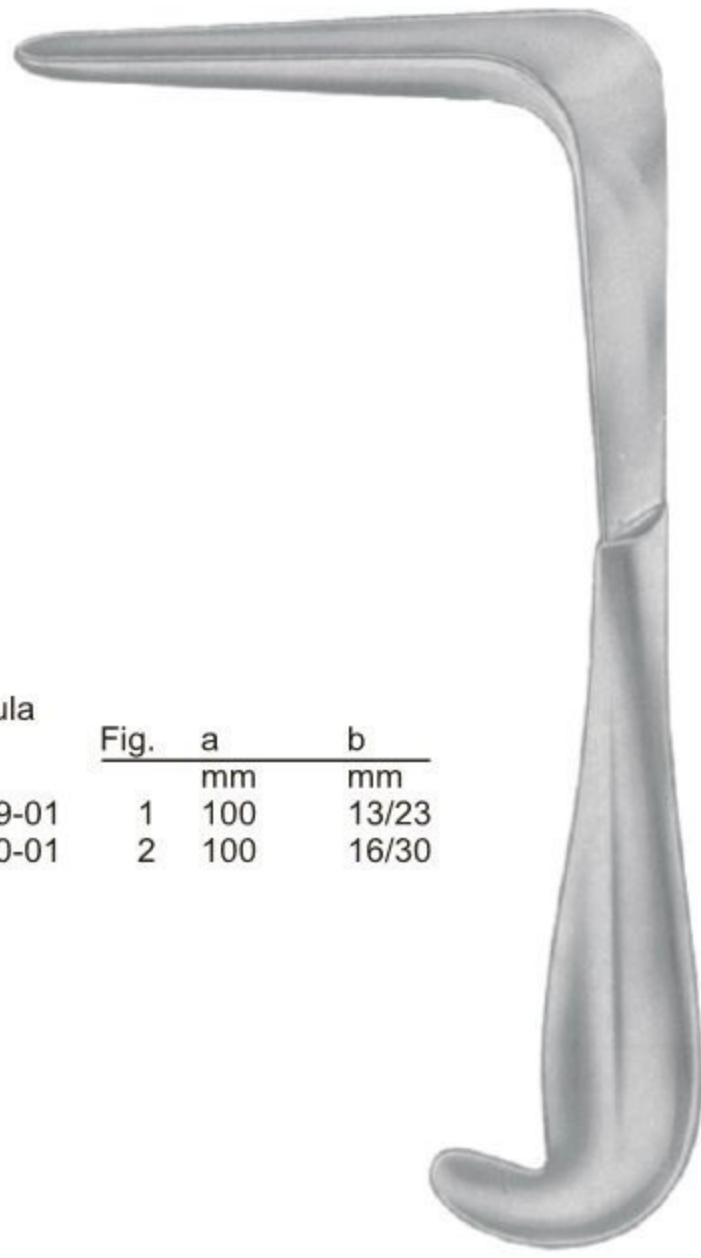

Mathieu

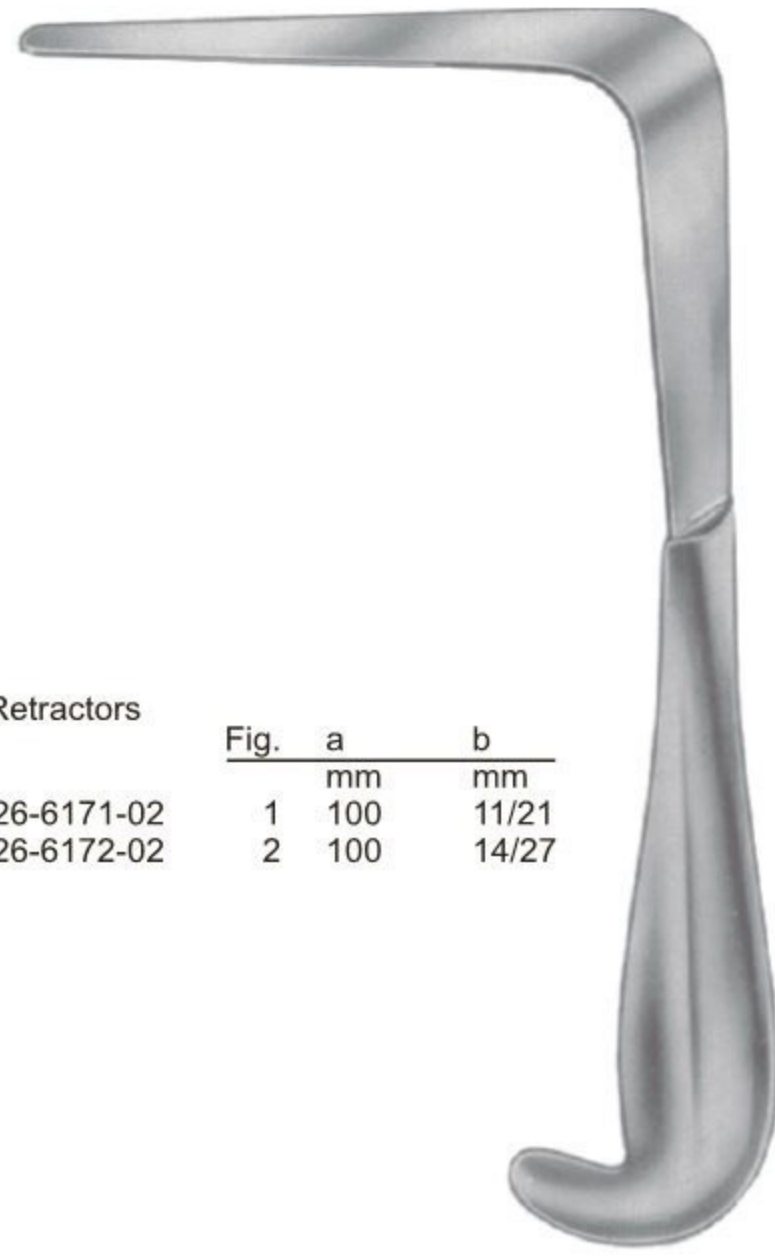

Mathieu

Specula			
	Fig.	a	b
		mm	mm
26-6169-01	1	100	13/23
26-6170-01	2	100	16/30

Retractors			
	Fig.	a	b
		mm	mm
26-6171-02	1	100	11/21
26-6172-02	2	100	14/27



Doyen



Doyen

Hollow handle 28cm/11"

	Fig.	a	b
		mm	mm
26-6173-01	1	75	45
26-6173-02	2	90	45
26-6173-03	3	110	45

26-6174-01	75 x 280mm
26-6174-02	90 x 280mm
26-6174-03	100 x 280mm
26-6174-03	115 x 280mm



Doyen 24 cm/9 1/2"		Fig.	a mm	b mm	Doyen 24 cm/9 1/2"	
slightly-concave					Medium-concave	
26-6175-01	1	55	35	26-6178-01		
26-6175-02	2	85	35	26-6178-02		
26-6175-03	3	115	35	26-6178-03		
26-6176-01	1	55	45	26-6179-01		
26-6176-02	2	85	45	26-6179-02		
26-6176-03	3	115	45	26-6179-03		
26-6176-04	4	160	45			
26-6176-05	5	180	45			
26-6177-01	1	55	60	26-6180-01		
26-6177-02	2	85	60	26-6180-02		
26-6177-03	3	115	60	26-6180-03		
26-6177-04	4	160	60			
26-6177-05	5	180	60			

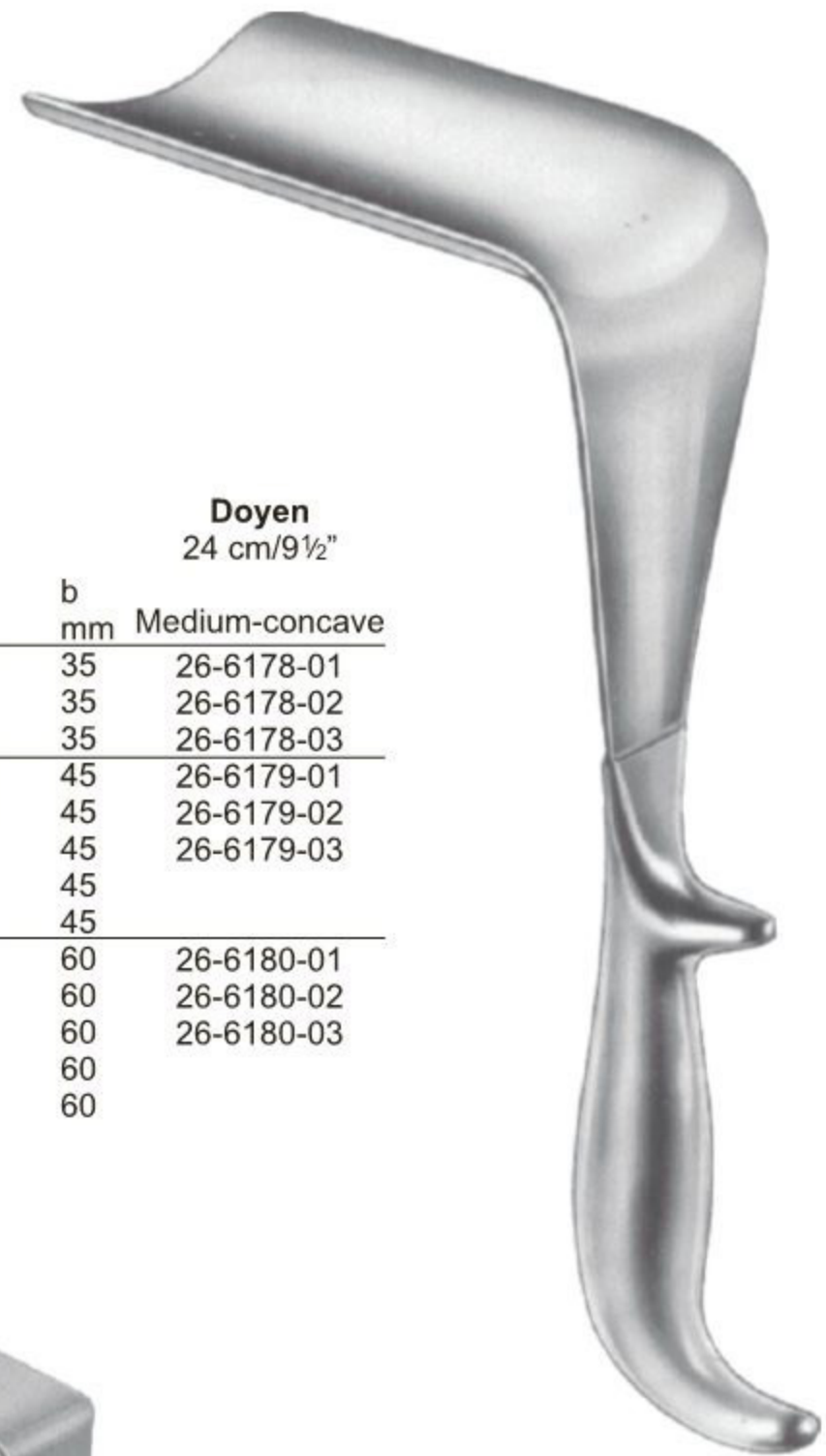

Doyen
25 cm/10"

	a mm	b mm
26-6181-01	60	30
26-6181-02	70	30
26-6181-03	80	30



Auvard
 with removable weight
 26-6182-01
 80x38 mm
 26-6182-02
 105x42 mm



Auvard
 with fixed weight
 26-6183-01
 70x38 mm
 26-6183-02
 102x45 mm



Landau

	a	b
	mm	mm
26-6184-01	100	28
26-6184-02	100	38



Breisky

	a	b
	mm	mm
26-6185-20	100	20
26-6185-25	100	25
26-6185-30	100	30
26-6185-35	100	35
26-6185-40	100	40
26-6186-20	130	20
26-6186-25	130	25
26-6186-30	130	30
26-6186-35	130	35
26-6186-40	130	40
26-6187-20	160	20
26-6187-25	160	25
26-6187-30	160	30
26-6187-35	160	35
26-6187-40	160	40
26-6188-20	180	20
26-6188-25	180	25
26-6188-30	180	30
26-6188-35	180	35
26-6188-40	180	40



Gelpi
Vulva self retaining
26-6189-20 20cm/8"



Comyn Berkeley
Vulva self retaining
26-6190-15 15.5cm/6"

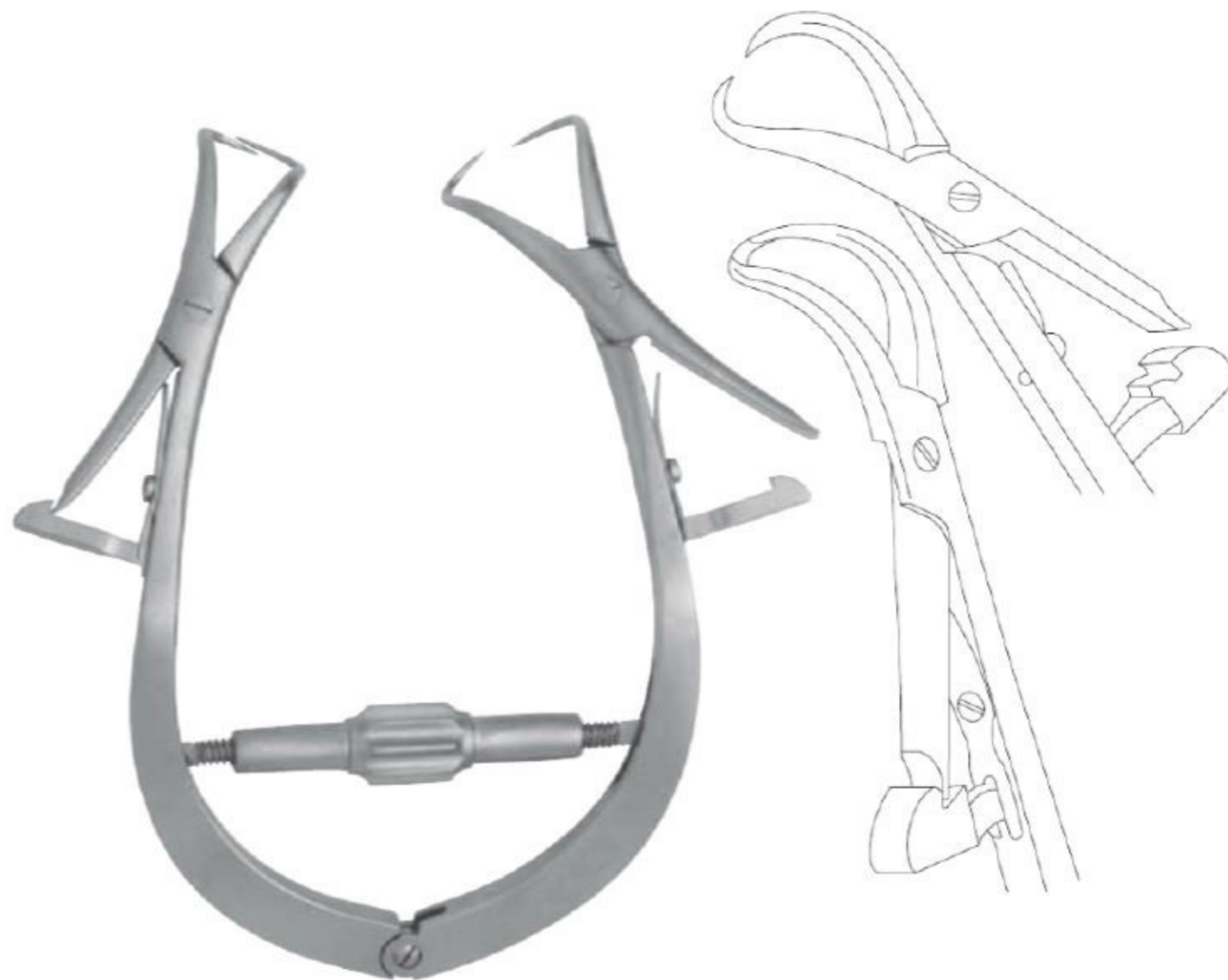

Joll
Thyroid self retaining
26-6191-15 15.5cm/6"

Lateral Wall Retractors ● EN
Wundspreizer ● DE
Separadores ● ES

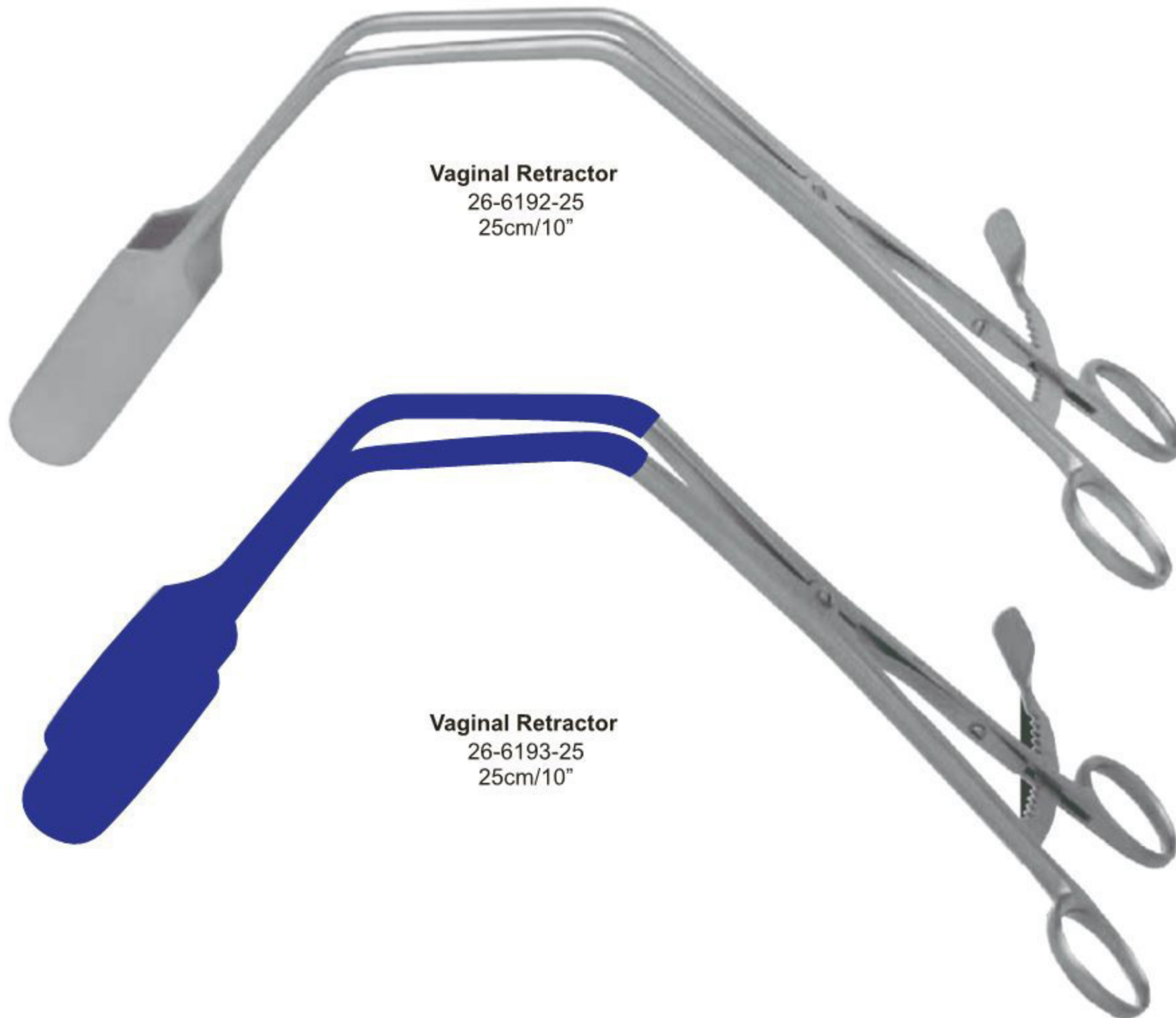
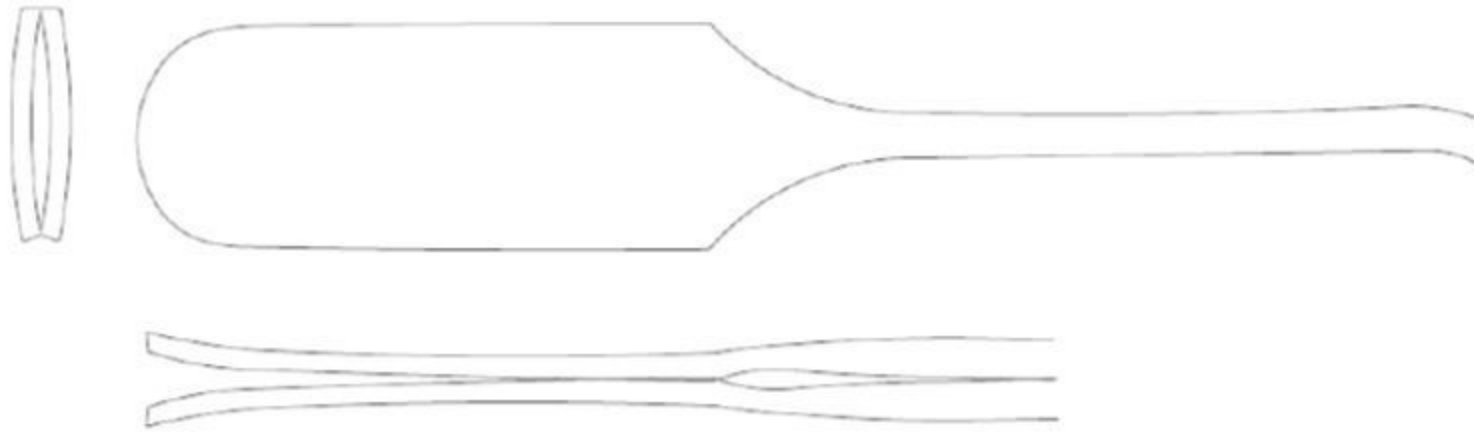

Vaginal Retractor
26-6192-25
25cm/10"

Vaginal Retractor
26-6193-25
25cm/10"



Scherbak
26-6194-00

Complete



26-6194-01
80x30 mm



26-6194-02
85x35 mm



26-6194-03
90x40 mm



26-6194-04
55x40/60 mm



26-6194-05
70x45/70 mm



	Fig.	a mm	b mm
26-6195-01	1	45	17
26-6195-02	2	90	37
26-6195-03	3	90	45



O'Sullivan-O'Connor
26-6195-00
Complete

Uterine Dilators ●— EN
 Uterus-Dilatatoren ●— DE
 Dilatadores uterinos ●— ES



Hegar
 single ended
 18.5 cm long

mmØ	
2.0	26-6196-02
3.0	26-6196-03
4.0	26-6196-04
5.0	26-6196-05
6.0	26-6196-06
7.0	26-6196-07
8.0	26-6196-08
9.0	26-6196-09
10.0	26-6196-10
11.0	26-6196-11
12.0	26-6196-12
13.0	26-6196-13
14.0	26-6196-14
15.0	26-6196-15
16.0	26-6196-16
17.0	26-6196-17
18.0	26-6196-18
19.0	26-6196-19
20.0	26-6196-20
21.0	26-6196-21
22.0	26-6196-22
23.0	26-6196-23
24.0	26-6196-24
25.0	26-6196-25
26.0	26-6196-26

Pieces per set

26-6197-50	12	3 -14 mm
26-6198-60	25	2 - 26 mm



Hegar
 double ended
 20 cm long

Ø mm	
1/2	26-6199-02
3/4	26-6199-04
5/6	26-6199-06
7/8	26-6199-08
9/10	26-6199-10
11/12	26-6199-12
13/14	26-6199-14
15/16	26-6199-16
17/18	26-6199-18
19/20	26-6199-20
21/22	26-6199-22
23/24	26-6199-24
25/26	26-6199-26

Pieces per set		set
26-6200-00	08	3/4 - 17/18 mm
26-6200-00	12	1/2 - 23/24 mm

EN —● Uterine Dilators
 DE —● Uterus-Dilatatoren
 ES —● Dilatadores uterinos



mm	
3/6	26-6202-03
4/7	26-6202-04
5/8	26-6202-05
6/9	26-6202-06
7/10	26-6202-07
8/11	26-6202-08
9/12	26-6202-09
10/13	26-6202-10
11/14	26-6202-11
12/15	26-6202-12
13/16	26-6202-13
14/17	26-6202-14
15/18	26-6202-15
16/19	26-6202-16
17/20	26-6202-17
18/21	26-6202-18

Hawkin Ambler
 26-6201-16
 17 cm long
 set of 16 3/6 - 18/21



Hank
 26-6203-30

mm	
9/10	26-6204-10
11/12	26-6204-12
13/14	26-6204-14
15/16	26-6204-16
17/18	26-6204-18
19/20	26-6204-20

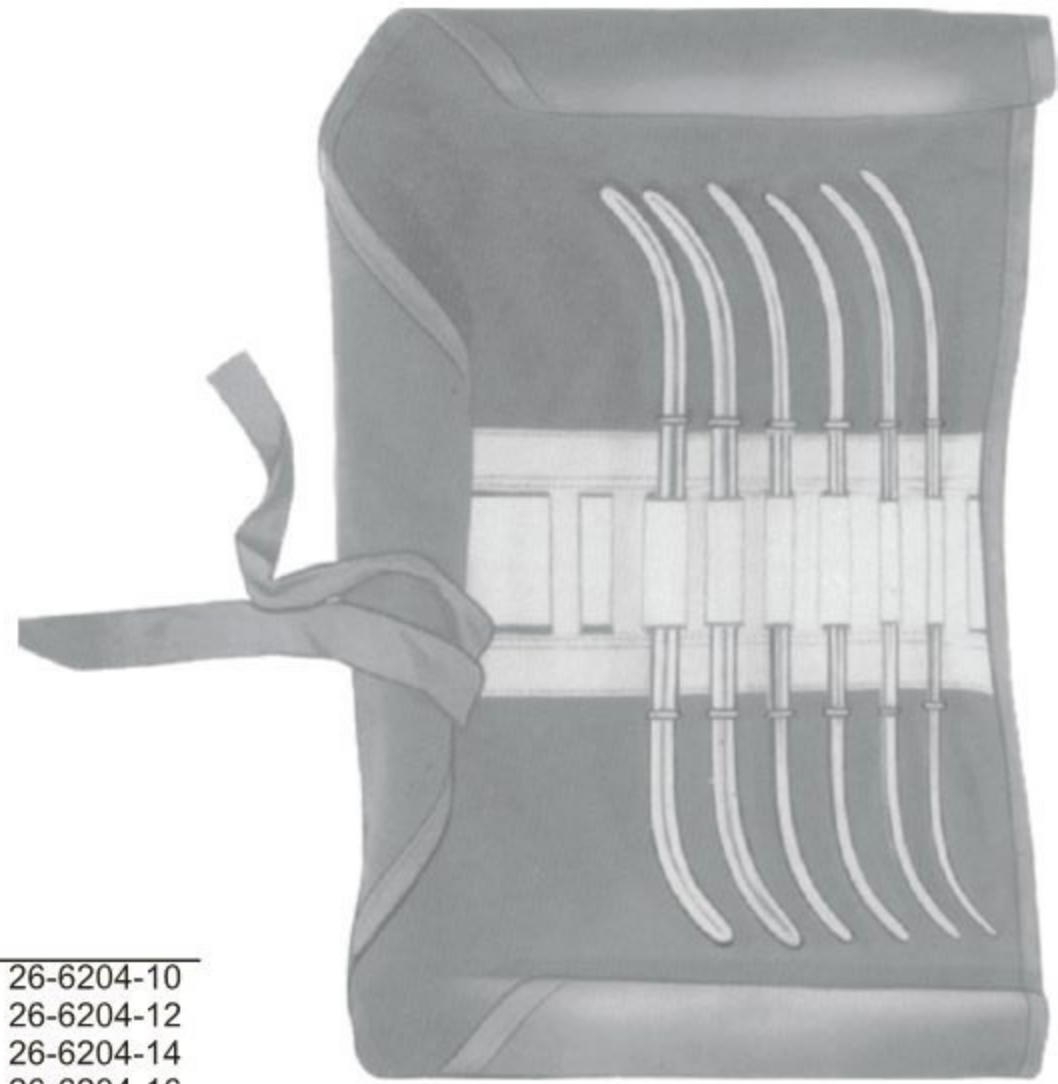

Set
 26-6205-00
 double ended
 27 cm



Pratt

mm	
13/15	26-6206-15
17/19	26-6206-19
21/23	26-6206-23
25/27	26-6206-27
29/31	26-6206-31
33/35	26-6206-35
37/39	26-6206-39
41/43	26-6206-43

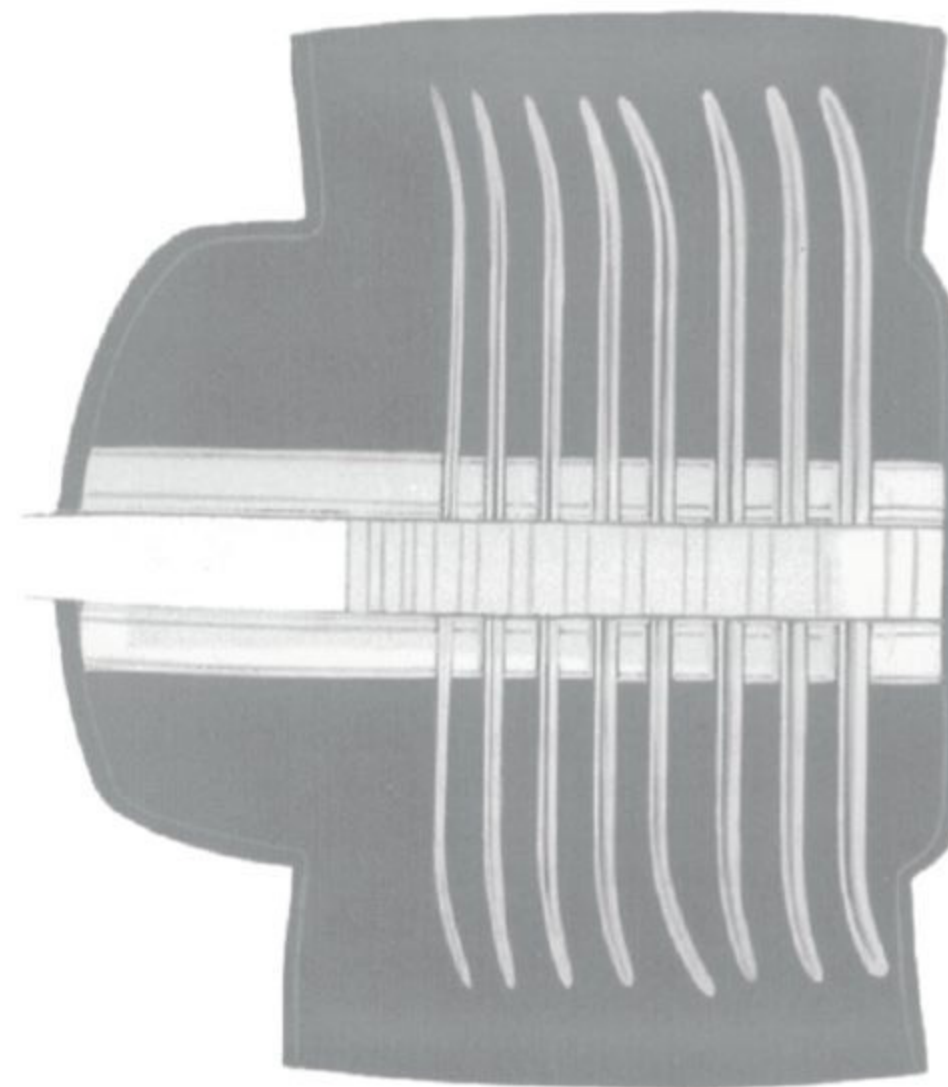

Set
 26-6207-00
 double ended
 29 cm

Tip 4 mm

Uterine Depressor



Sims
32 cm/12½"

Martin (Simpson)
32 cm/12½"

Valleix
26-6214-25
25 cm/10"

Collin
26-6215-28
28 cm/11"

Braun
26-6216-28
28 cm/11"

Rigid	cm	cm
	26-6208-32	26-6211-32

Malleable	cm / in	cm / in
	26-6209-32	26-6212-32
	26-6210-32	26-6213-32

Laser Probes



26-6217-01



90°

26-6217-02



45°

26-6217-03



20°

Measuring Probe



26-6218-01

Laser Probe



26-6219-01



90°

26-6219-02



45°

26-6219-03



20°

Depth Ruler



26-6220-01

Measuring Instruments

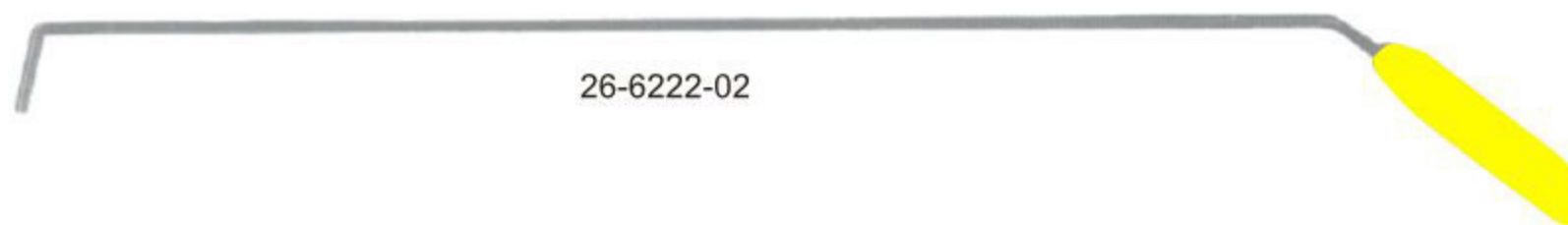

Hooks



EN —● Corn Knives, Fistula Hooks, Myoma Instruments

DE —● Konusmesser, Fistelhaken, Myom-instrumente

ES —● Bisturí p. conos de atraccion, Ganchos p. fistulas, instrumentos para fibroma



Ayre
26-6228-23
23 cm/9"



Simon
26-6229-22
22 cm/8¾"



Simon
26-6230-22
22 cm/8¾"



Emmet
22 cm/8¾"



26-6231-01



26-6231-02



26-6231-03



26-6231-04

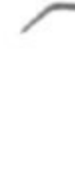

26-6231-05



Doyen
26-6232-17
17 cm/6¾"



Doyen
26-6233-17
17 cm/6¾"



Segond
26-6234-27
27 cm/10½"

Secretion Spoon



26-6235-27
27 cm/10½"



Muenchen
27 cm/10½"



26-6236-04
4 mm



26-6236-05
5 mm



Randall
26-6237-24
24 cm/9½"

4 mmØ



Novak
23 cm/9"

- 26-6238-01
1 mm
- 26-6238-02
2 mm
- 26-6238-03
3 mm
- 26-6238-04
4 mm



Novak-Schoeckaert
26-6239-24
24 cm/9"



Kevorkian
 26-6240-30
 30 cm/12"

malleable
 26-6241-30
 30 cm/12"



Kevorkian
 26-6242-30
 30 cm/12"

malleable
 26-6243-30
 30 cm/12"



Townsend
 26-6244-30
 31 cm/12¼"

malleable
 26-6245-30
 31 cm/12¼"



Duncan
 26-6246-31
 31 cm/12¼"



Duncan
 26-6247-31
 31 cm/12¼"

Periosteal Raspatories ●— EN
 Raspatorien ●— DE
 Legras-Periostótomos ●— ES



Goodell
 26-6248-34
 34 cm/13½"



Kogan-Laser
 28 cm/11"



26-6251-28
 28 cm/11"



Kogan
 26-6252-24
 24 cm/9½"

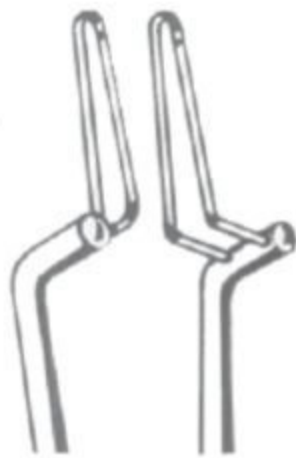

Kogan
 26-6253-24
 24 cm/9½"



Kogan
 28 cm/11"





Martin
 26-6256-27
 27 cm/10½"



Staude-Moore
 26-6257-17
 17 cm/6¾"



Barrett
 26-6258-18
 18 cm/7"



Schroeder
 26-6259-25
 25 cm/10"



Braun
 26-6260-25
 25 cm/10"



Collin-Pozzi
 26-6261-25
 25 cm/10"



Pozzi
 26-6262-25
 25.5 cm/10¼"

Strong Pattern



Duplay
 26-6263-28
 28 cm/11"



Skene
 26-6264-24
 24 cm/9½"

Amniotome for the
 amnion Bladder



Beacham
 26-6265-26
 26 cm/10¼"



Czerny
 26-6266-20
 20.5 cm/8¼"



26-6267-26
 26 cm/10¼"



Schroeder
 26-6268-20 20 cm/8"
 26-6268-24 24 cm/9½"

Straight



Schroeder
 26-6269-20
 26-6269-24

Curved on Flat



Schroeder
 26-6270-20
 26-6270-24

Curved Sideway

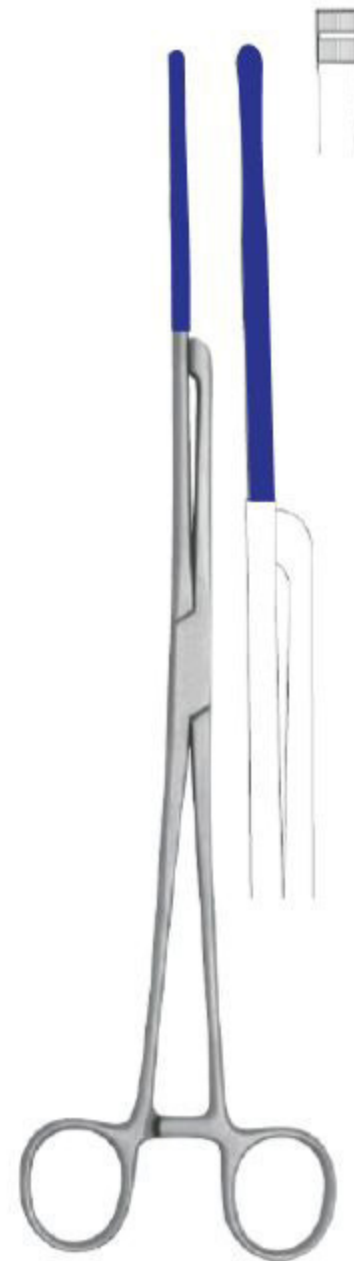

Atrauma
 26-6271-29
 Vulsellum Forcep
 29cm/11 ½"

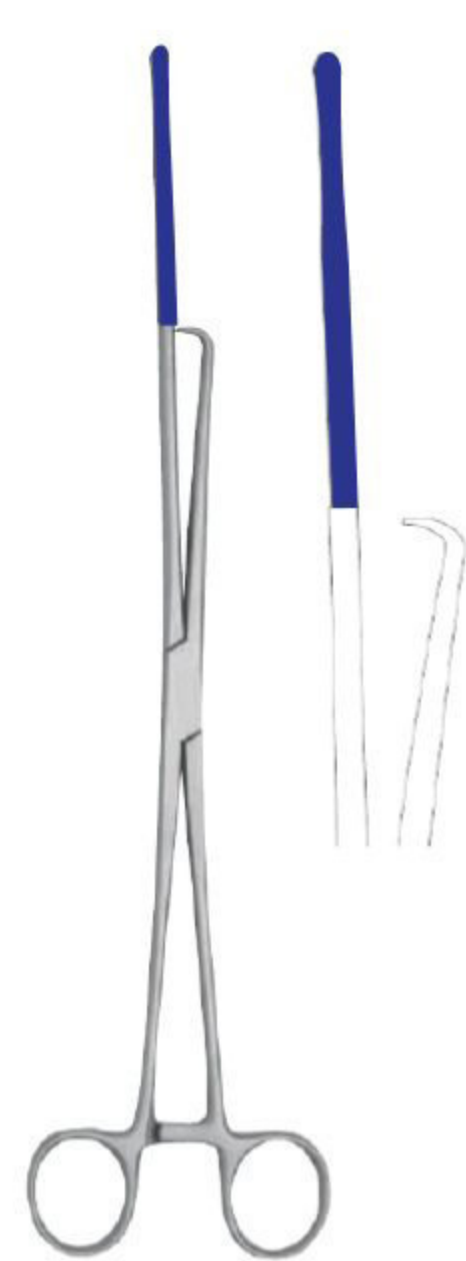

Luer
 26-6272-30
 Vulsellum Forcep
 30.5cm/12"

EN —● Tenaculum Forceps
 DE —● Hakenzangen
 ES —● Pinzas para coger el cuello del útero



Atrauma
 26-6273-29
 29cm/11 1/2"



Bozeman
 26-6274-27
 27cm/10 1/2"



26-6275-23
 23cm/9"
 jaw 1/8"

26-6276-23
 23cm/9"
 jaw 1/4"



Rotunda
 26-6277-27
 27cm/10 1/2"



Bierer
 26-6278-24
 24cm/9 1/2"



Straight
 26-6279-06
 26-6279-08
 26-6279-10



Museux
 24 cm/9 1/2"
 06 mm
 08 mm
 10 mm



Curved Sideway
 26-6280-06
 26-6280-08
 26-6280-10



Straight
 26-6281-06
 26-6281-08
 26-6281-10



Museux
 24 cm/9 1/2"
 06 mm
 08 mm
 10 mm



Curved Sideway
 26-6282-06
 26-6282-08
 26-6282-10



Braun
 26-6283-16
 16 cm/6 1/4"

Tenaculum Forceps ●— EN
 Hakenzangen ●— DE
 Pinzas para coger el cuello del útero ●— ES

For the amnion Bladder



Pratt
 26-6284-28
 28 cm/11"



Teale
 26-6285-24
 24 cm/9½"



Iowa
 26-6286-26
 26 cm/10¼"



Jacobs
 Straight Curved Sideway
 26-6287-21 26-6288-21
 21 cm/8¼"



Bonney Polypus
 26-6289-26
 24 cm/9 ½"



Kelly
 26-6290-32
 32 cm/12½"



Heywood-Smith
 26-6291-20
 20 cm/8"



Heywood-Smith
 26-6292-25
 25 cm/10"



Noto
 26-6293-27
 27 cm/10½"

EN —● Uterine Elevating, Ovarian Forceps, Vaginal Clamps

DE —● Uterus-Faßzangen

ES —● Pinzas para el útero



Dartigues
26-6294-27
27 cm/10½"



Somer
26-6295-23
23 cm/9"



Collin
26-6296-25
25 cm/10"



Ovarian Forceps

Doyen
26-6297-18 18 cm/7"
26-6297-20 20 cm/8"



Bonney
26-6298-34
34.5 cm/13 ½"



Bonney
26-6299-27
27 cm/10½"



Bonney
26-6300-20
20 cm/8"
curved



Bonney Berkley
26-6301-20
20 cm/8"
angled



Gellhorn
 26-6302-23
 23 cm/9"



Thoms-Gaylor
 26-6303-24
 24 cm/9½"



Schubert
 26-6304-21 21 cm/8¼"
 26-6304-29 29 cm/11¼"



Schubert
 26-6305-26
 26 cm/10¼"



Tischler
 26-6306-27
 27 cm/10½"



Van Doren
 26-6307-25
 25 cm/10"

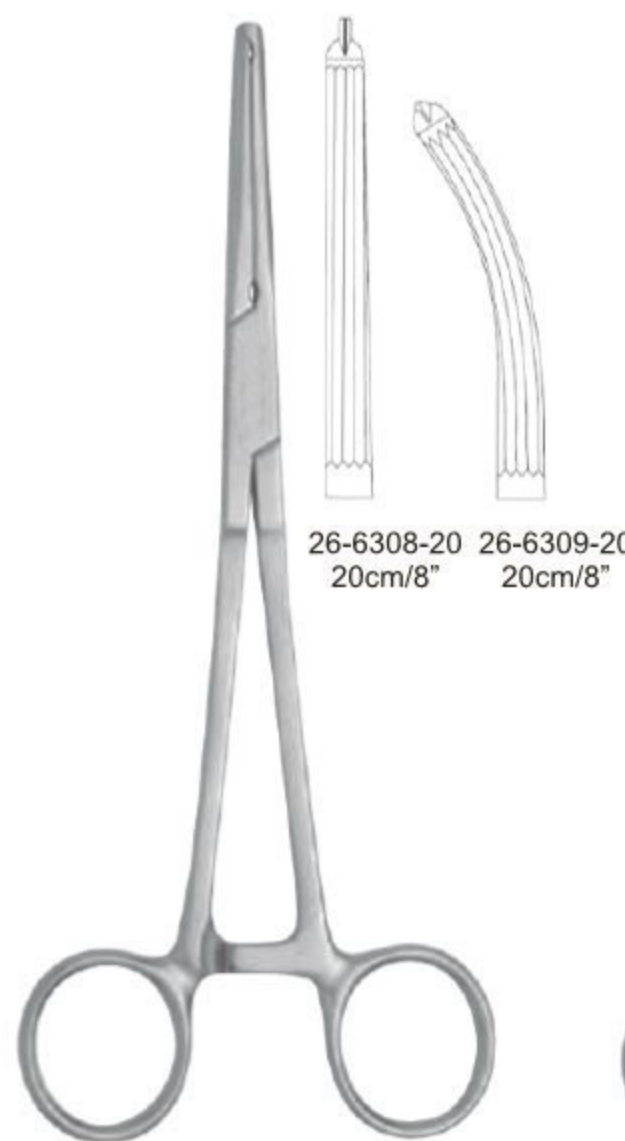

Gwilliam

26-6308-20 20cm/8"
 26-6309-20 20cm/8"



Hunter
 26-6310-23
 23 cm/9"

EN —● Cervical Biopsy and Specimen Forceps
 DE —● Probeexzisionszangen
 ES —● Pinzas saca-bocados para biopsia

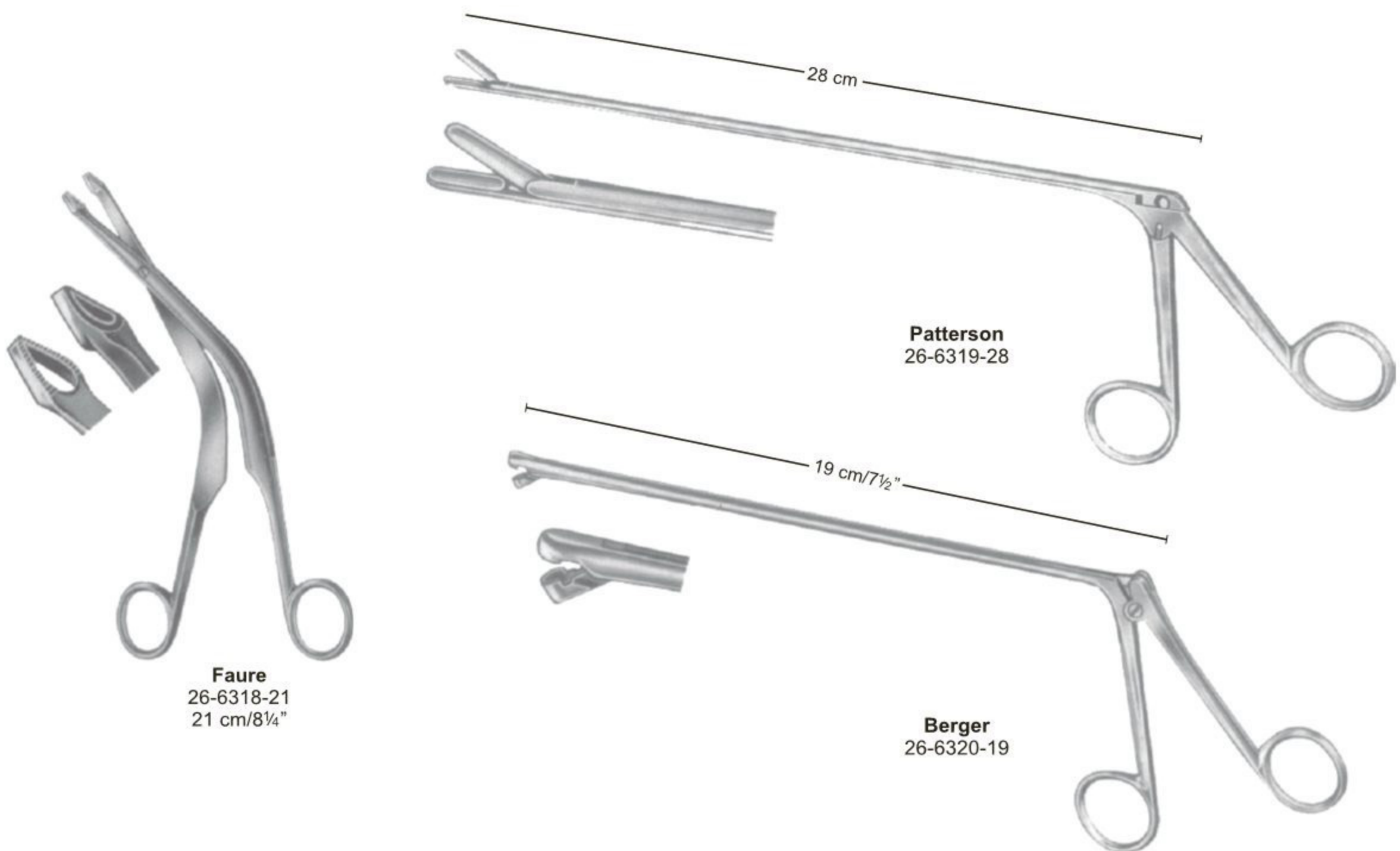
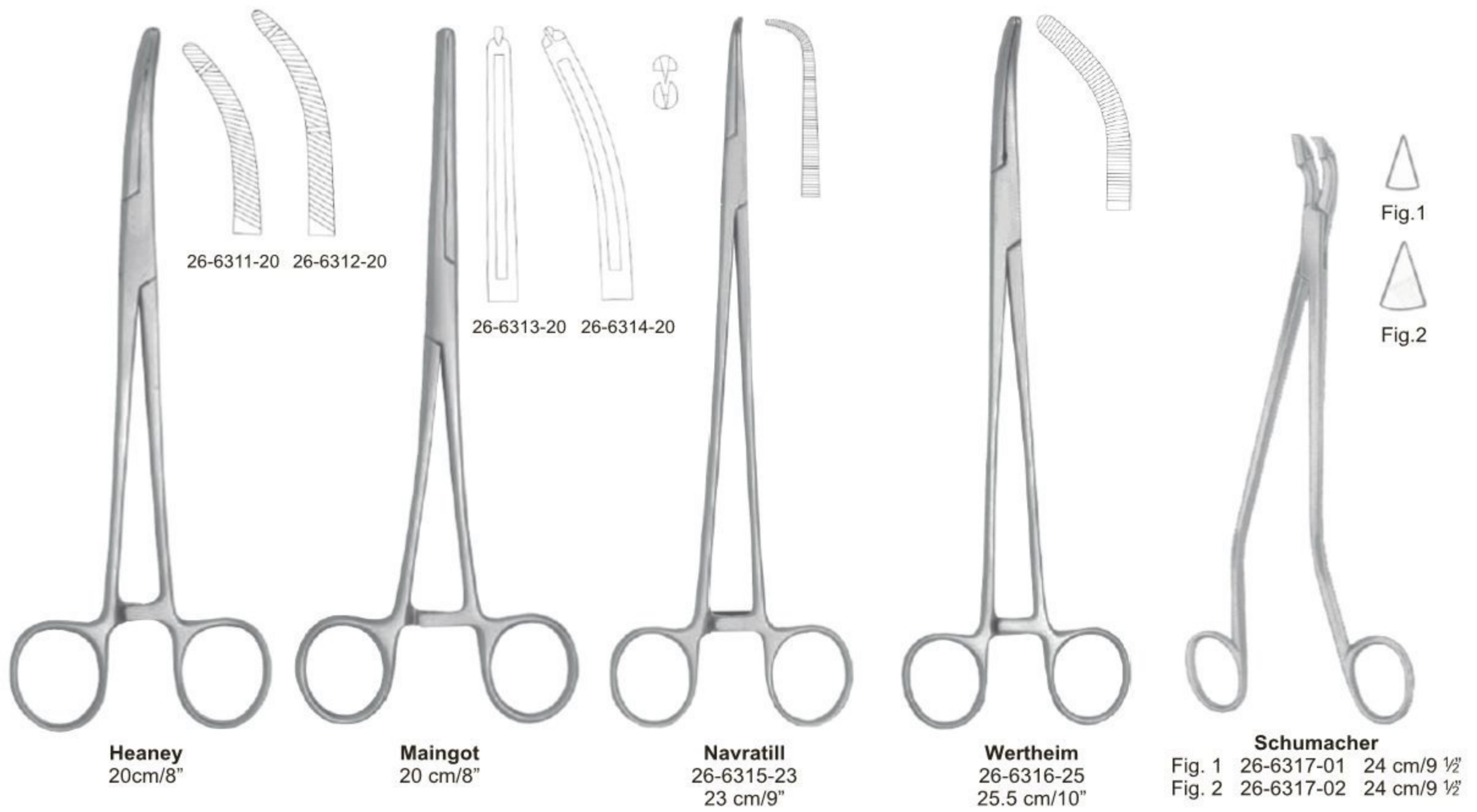



- 26-6321-20 L= 20 cm/8"
- 26-6321-25 L= 25 cm/10"
- 26-6321-30 L= 30 cm/12"
- 26-6321-35 L= 35 cm/14"
- 26-6321-40 L= 40 cm/16"



- 26-6323-04 4 mm
- 26-6323-06 6 mm

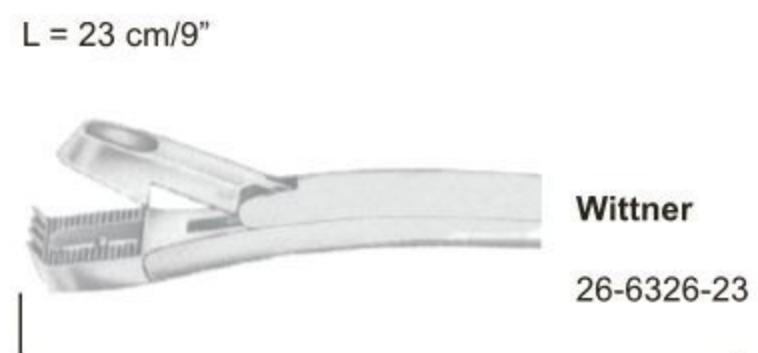
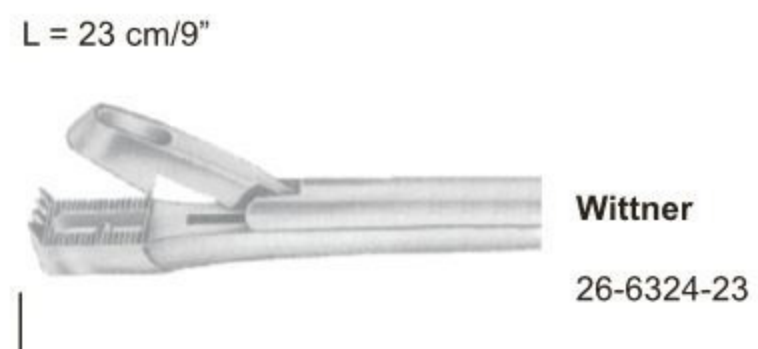

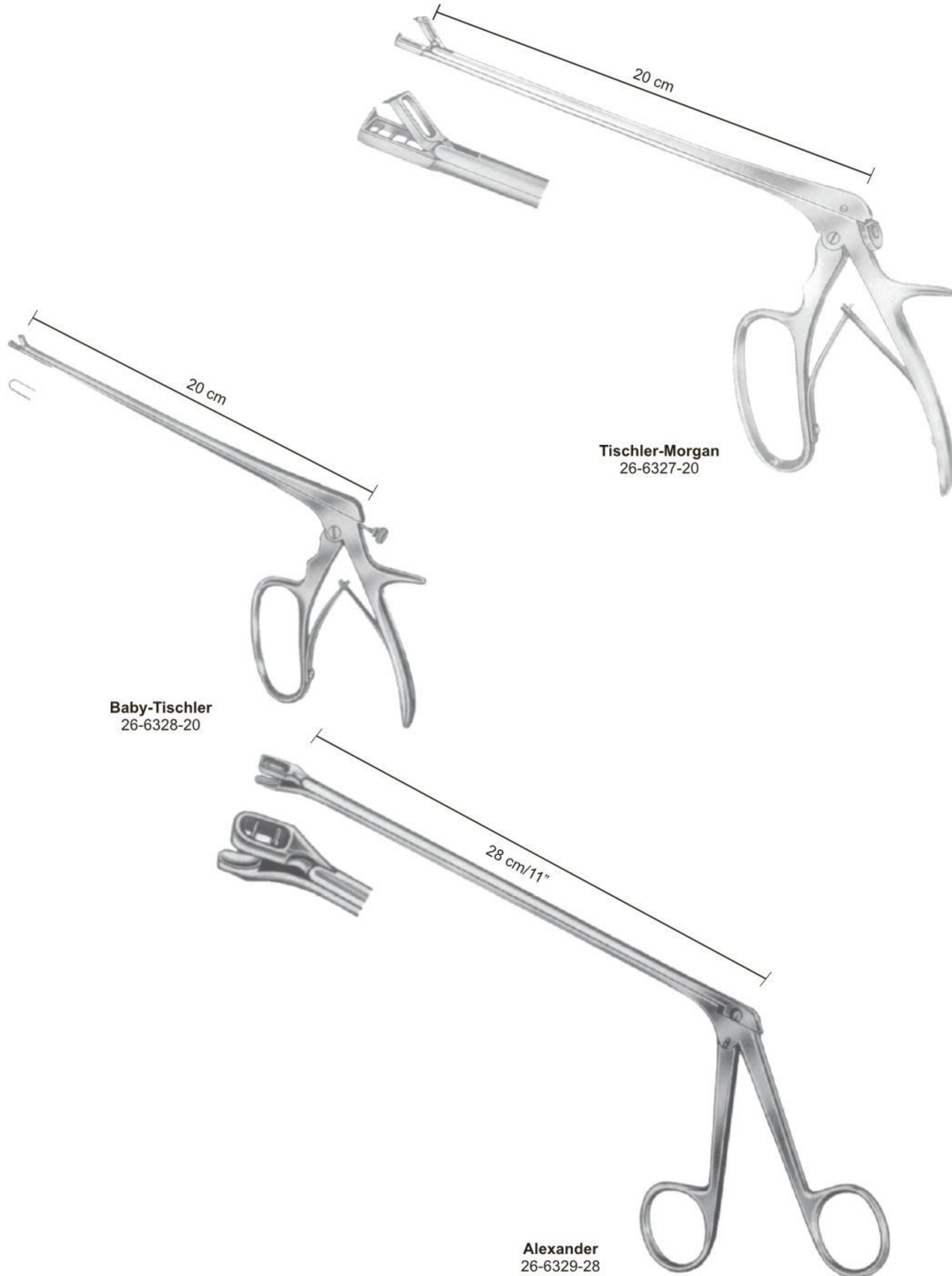

Cervical Biopsy and Specimen Forceps ● EN
 Probeexzisionszangen ● DE
 Pinzas saca-bocados para biopsia ● ES

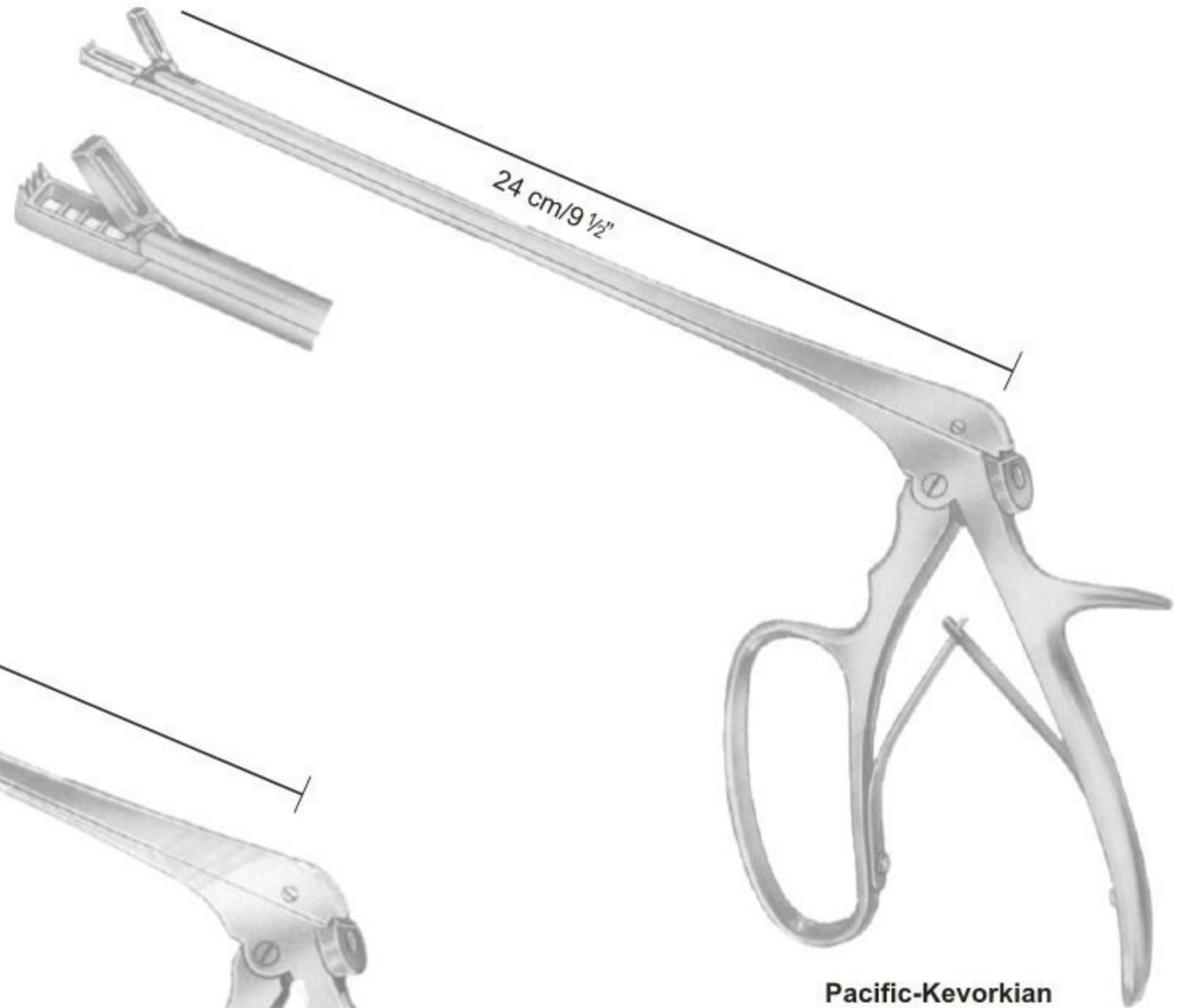

Pacific-Kevorkian
26-6330-24

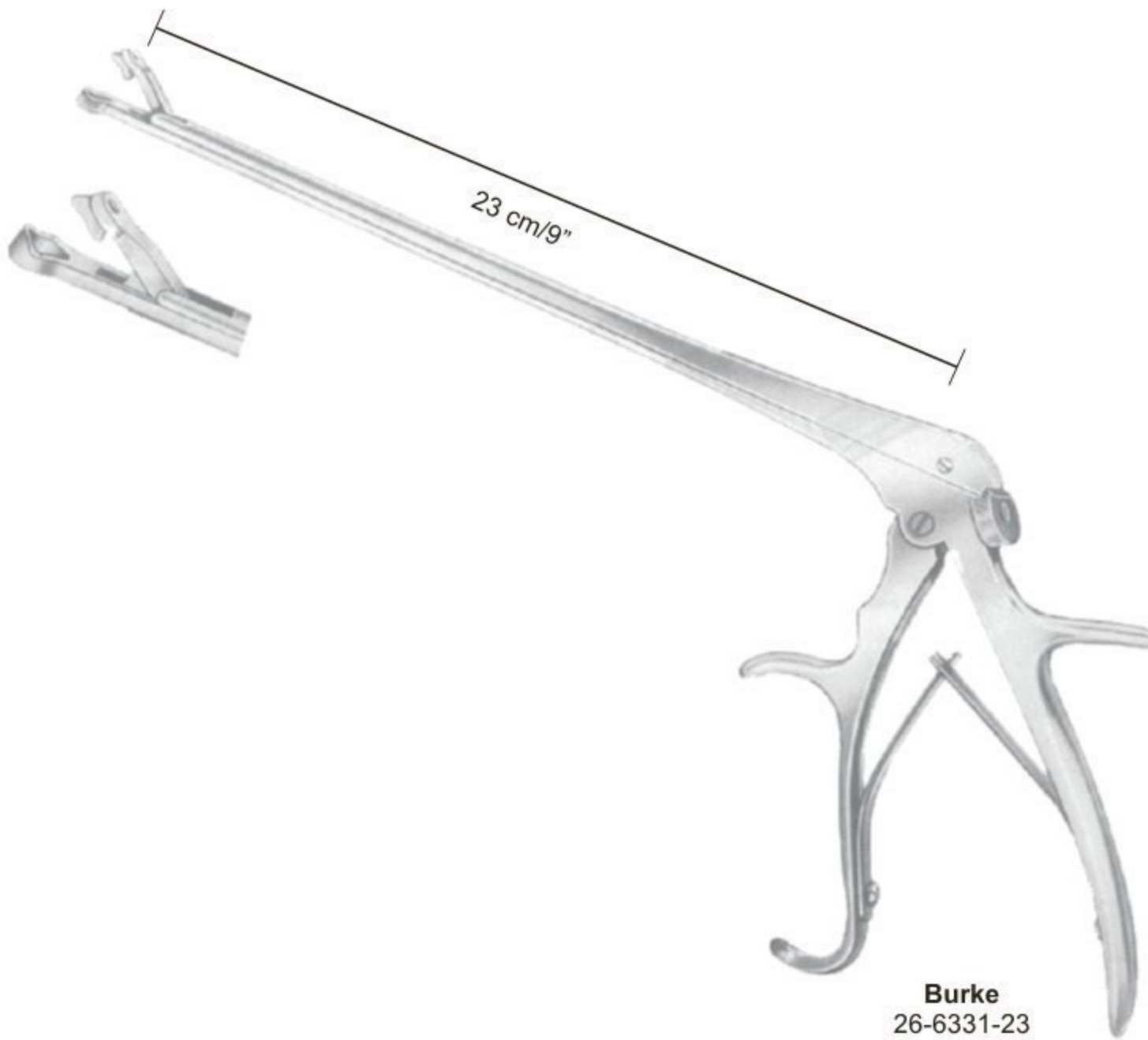

Burke
26-6331-23

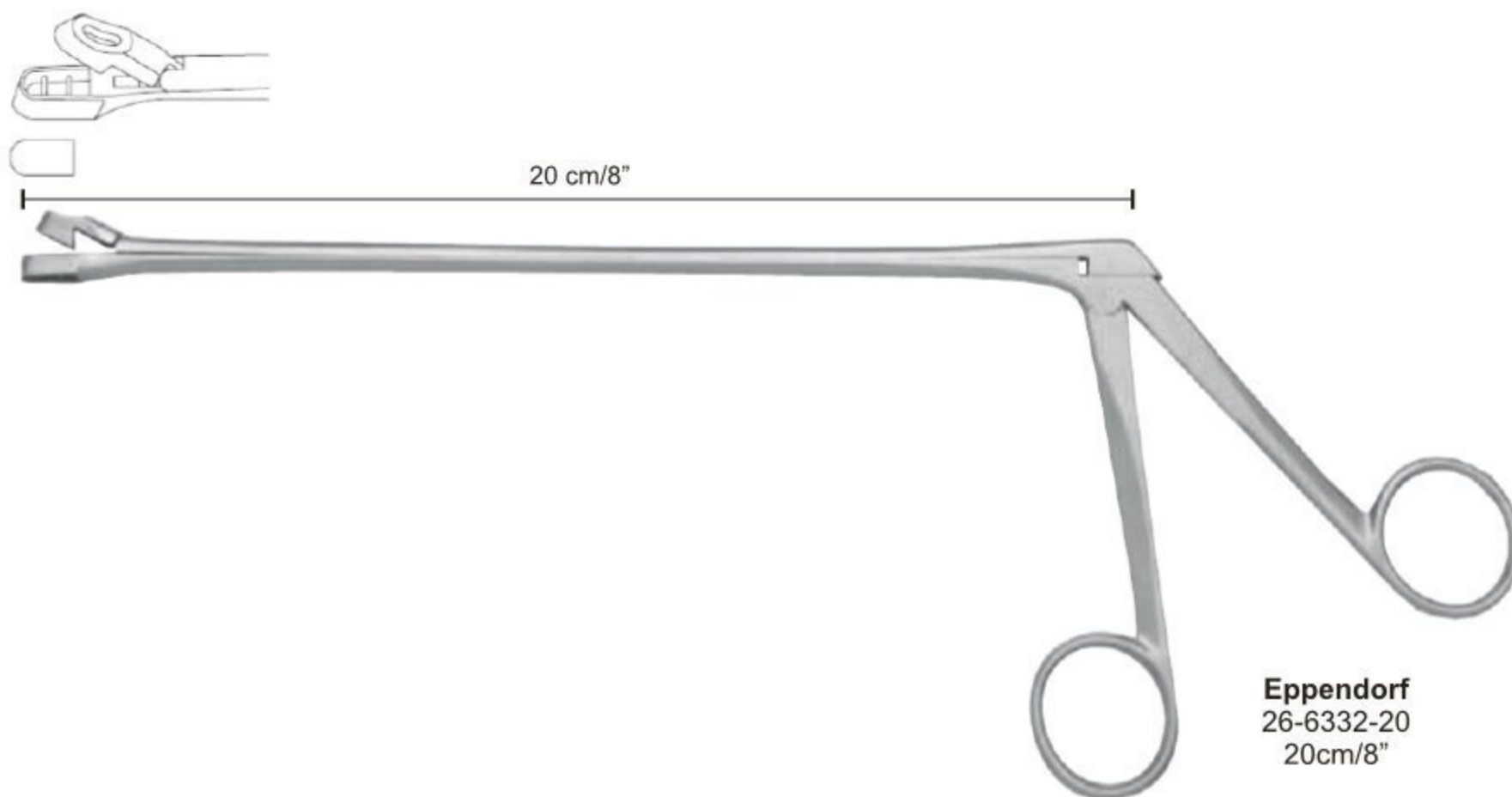

Eppendorf
26-6332-20
20cm/8"











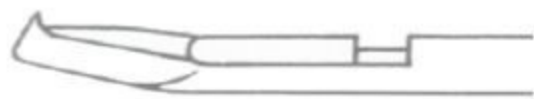

Townsend

Handle

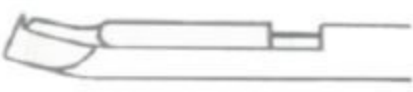

Tip with tube

		Complete instrument	Tip, only
	Tischler	26-6333-00	26-6334-01
	Kevorkian	26-6335-00	26-6336-01
	Mini-Townsend	26-6337-00	26-6338-01
	 Tischler-up	26-6339-00	26-6340-01
	 Tischler-down	26-6341-00	26-6342-01
	 Mini-Townsend-up	26-6343-00	26-6344-01
	 Mini-Townsend-down	26-6345-00	26-6346-01

Uterine Curettes ● EN
 Uterusküretten ● DE
 Curetas uterinas ● ES



Schroeder
30 cm/12"

Sharp Rigid

Schroeder
Simon



Fig. 1
26-6347-01
26-6348-01



Fig. 2
26-6349-02
26-6350-02



Fig. 3
26-6351-03
26-6352-03



Fig. 4
26-6353-04
26-6354-04



Fig. 5
26-6355-05
26-6356-05



Fig. 6
26-6357-06
26-6358-06

Schroeder
Simon



Simon
25 cm/10"



Gourdet
28 cm/11"



Fig. 1
26-6359-01
6 mm



Fig. 2
26-6359-02
8 mm



Fig. 3
26-6359-03
10 mm



Fig. 4
26-6359-04
12 mm



Fig. 5
26-6359-05
14 mm



Thomas



Fig. 1
26-6360-01



Fig. 2
26-6360-02



Fig. 3
26-6360-03



Fig. 4
26-6360-04



Fig. 5
26-6360-05



Fig. 6
26-6360-06



Greene

26-6361-10
10 mm

26-6361-12
12 mm

26-6361-14
14 mm



Collin
26-6362-30
30 cm/12"



Heaney
26-6363-24
24 cm/9½"



Heaney
26-6364-24
24 cm/9½"

Aspirating Curettes ●— EN
 Absaugküretten ●— DE
 Curetas de aspiración ●— ES



Milan
28.5 cm/11¼"

Malleable



26-6365-05
5 mm Ø



26-6367-07
7 mm Ø



26-6369-09
9 mm Ø

Rigid

26-6366-05
5 mm Ø

26-6368-07
7 mm Ø

26-6370-09
9 mm Ø



28 cm/11"

- | | Ø |
|------------|---------|
| 26-6371-04 | 4.0 mm |
| 26-6371-06 | 6.0 mm |
| 26-6371-08 | 8.0 mm |
| 26-6371-10 | 10.0 mm |
| 26-6371-12 | 12.0 mm |
| 26-6371-14 | 14.0 mm |
| 26-6371-16 | 16.0 mm |

Hose Connecting Piece



26-6372-00

EN —● Uterine Curettes
 DE —● Uterusküretten
 ES —● Curetas uterinas

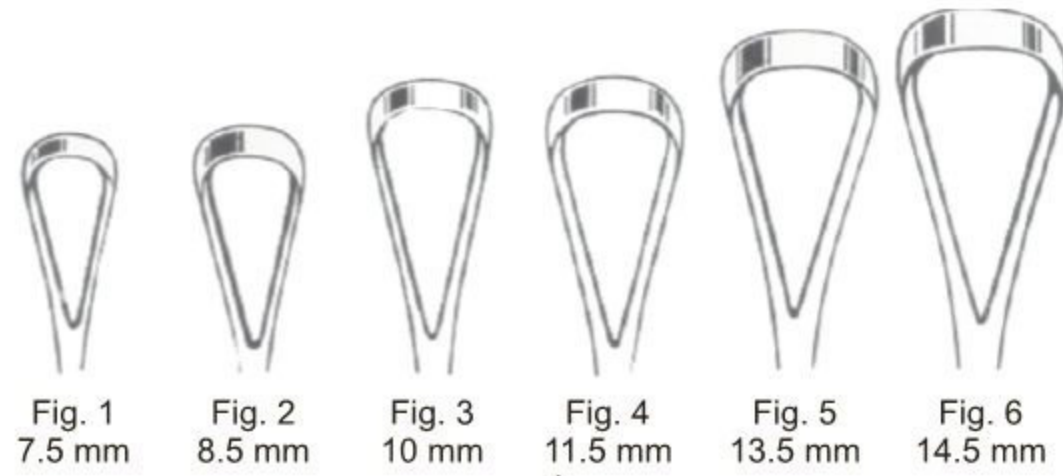

		Malleable		Rigid	
		Sharp	Blunt	Sharp	Blunt
Fig. 1	26-6373-01	26-6374-01		26-6375-01	26-6376-01
Fig. 2	26-6373-02	26-6374-02		26-6375-02	26-6376-02
Fig. 3	26-6373-03	26-6374-03		26-6375-03	26-6376-03
Fig. 4	26-6373-04	26-6374-04		26-6375-04	26-6376-04
Fig. 5	26-6373-05	26-6374-05		26-6375-05	26-6376-05
Fig. 6	26-6373-06	26-6374-06		26-6375-06	26-6376-06

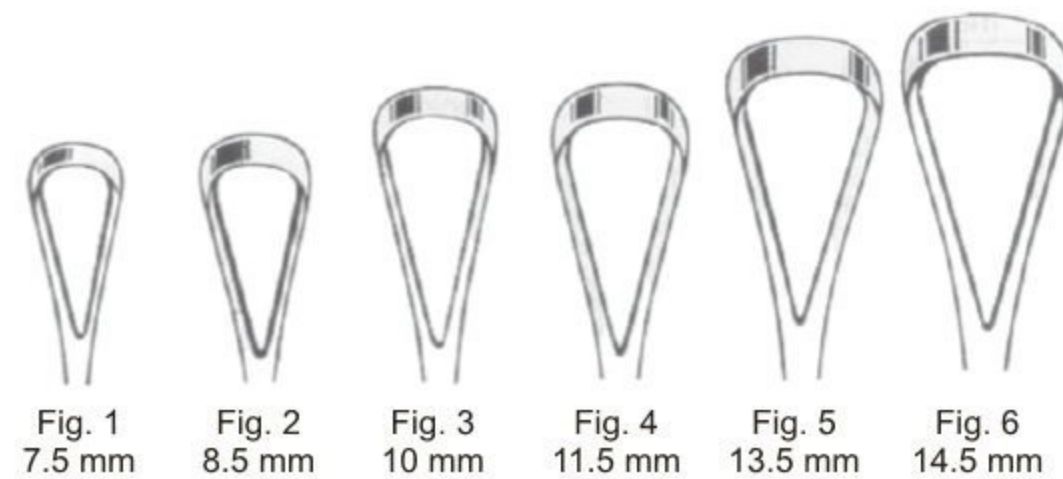

		Malleable		Rigid	
		Sharp	Blunt	Sharp	Blunt
Fig. 1	26-6377-01	26-6378-01		26-6379-01	26-6380-01
Fig. 2	26-6377-02	26-6378-02		26-6379-02	26-6380-02
Fig. 3	26-6377-03	26-6378-03		26-6379-03	26-6380-03
Fig. 4	26-6377-04	26-6378-04		26-6379-04	26-6380-04
Fig. 5	26-6377-05	26-6378-05		26-6379-05	26-6380-05
Fig. 6	26-6377-06	26-6378-06		26-6379-06	26-6380-06

Uterine Curettes ●— EN
 Uterusküretten ●— DE
 Curetas uterinas ●— ES



Rigid



Malleable



Recamier

26 cm

31 cm

Fig.	mm	Malleable		Rigid		Malleable		Rigid	
		Sharp	Blunt	Sharp	Blunt	Sharp	Blunt	Sharp	Blunt
00	5	26-6381-05	26-6382-05	26-6383-05	26-6384-05	26-6385-05	26-6386-05	26-6387-05	26-6388-05
0	6	26-6381-06	26-6382-06	26-6383-06	26-6384-06	26-6385-06	26-6386-06	26-6387-06	26-6388-06
1	7	26-6381-07	26-6382-07	26-6383-07	26-6384-07	26-6385-07	26-6386-07	26-6387-07	26-6388-07
2	8	26-6381-08	26-6382-08	26-6383-08	26-6384-08	26-6385-08	26-6386-08	26-6387-08	26-6388-08
3	9	26-6381-09	26-6382-09	26-6383-09	26-6384-09	26-6385-09	26-6386-09	26-6387-09	26-6388-09
4	10	26-6381-11	26-6382-11	26-6383-11	26-6384-11	26-6385-11	26-6386-11	26-6387-11	26-6388-11
5	12	26-6381-12	26-6382-12	26-6383-12	26-6384-12	26-6385-12	26-6386-12	26-6387-12	26-6388-12
6	14	26-6381-14	26-6382-14	26-6383-14	26-6384-14	26-6385-14	26-6386-14	26-6387-14	26-6388-14
7	15	26-6381-15	26-6382-15	26-6383-15	26-6384-15	26-6385-15	26-6386-15	26-6387-15	26-6388-15
8	16	26-6381-16	26-6382-16	26-6383-16	26-6384-16	26-6385-16	26-6386-16	26-6387-16	26-6388-16
9	19	26-6381-19	26-6382-19	26-6383-19	26-6384-19	26-6385-19	26-6386-19	26-6387-19	26-6388-19
10	20	26-6381-20	26-6382-20	26-6383-20	26-6384-20	26-6385-20	26-6386-20	26-6387-20	26-6388-20
11	21	26-6381-21	26-6382-21	26-6383-21	26-6384-21	26-6385-21	26-6386-21	26-6387-21	26-6388-21
12	23	26-6381-23	26-6382-23	26-6383-23	26-6384-23	26-6385-23	26-6386-23	26-6387-23	26-6388-23
13	25					26-6385-25	26-6386-25	26-6387-25	26-6388-25
14	30					26-6385-30	26-6386-30	26-6387-30	26-6388-30
15	35					26-6385-35	26-6386-35	26-6387-35	26-6388-35
16	40					26-6385-40	26-6386-40	26-6387-40	26-6388-40



Bumm
max. 29 cm/11½"

Fig.	mm	Mealleable	
		Sharp	Blunt
0	16.0	26-6389-16	26-6390-16
1	18.0	26-6389-18	26-6390-18
2	19.5	26-6389-19	26-6390-19
3	21.5	26-6389-21	26-6390-21
4	23.5	26-6389-23	26-6390-23
5	26.0	26-6389-26	26-6390-26
6	28.5	26-6389-28	26-6390-28



Blunt

Sharp

Blake (Zweifel)
26-6391-27 27 cm/10½"
26-6391-31 31 cm/12¼"



Zeppelin Scissor with TC

slightly curved
 26-6392-23 23cm/9"
 26-6392-26 26.5cm/10 1/2"
 26-6392-30 30cm/12"

curved
 26-6393-23 23cm/9"
 26-6393-26 26.5cm/10 1/2"
 26-6393-30 30cm/12"

Fully curved
 26-6394-23 23cm/9"
 26-6394-26 26.5cm/10 1/2"
 26-6394-30 30cm/12"

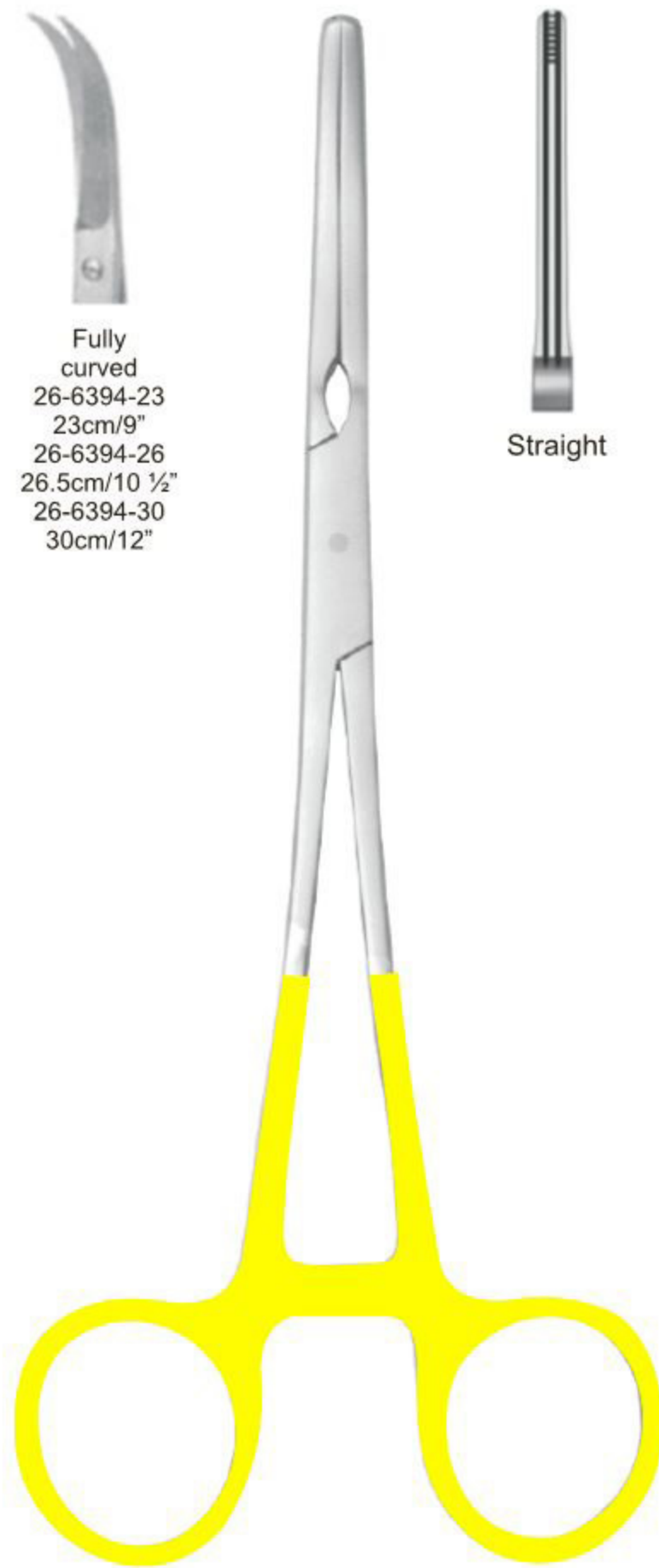

Zeppelin Clamps

offset handle with gold rings (without TC)

Straight	26-6395-21	26-6399-24	26-6403-30	26-6407-35
Slightly Curved	26-6396-21	26-6400-24	26-6404-30	26-6408-35
Strongly Curved	26-6397-21	26-6401-24	26-6405-30	26-6409-35
Angled	26-6398-21	26-6402-24	26-6406-30	26-6410-35
	21.5cm/8 1/2"	24cm/9 1/2"	30cm/12"	35cm/14"



Zeppelin Clamps

Straight Handle with gold rings (without TC)

Straight	26-6411-21	26-6415-24	26-6419-30	26-6423-35
Slightly Curved	26-6412-21	26-6416-24	26-6420-30	26-6424-35
Strongly Curved	26-6413-21	26-6417-24	26-6421-30	26-6425-35
Angled	26-6414-21	26-6418-24	26-6422-30	26-6426-35
	21.5cm/8 1/2"	24cm/9 1/2"	30cm/12"	35cm/14"