

DENTAL INSTRUMENTS CATALOGUE



  
**Dynamic**  
Products



## Extracting Forceps “English Pattern”



**1001**  
Fig. 4  
lower incisor



**1001**  
Fig. 4  
lower incisor



**1002**  
Fig. 8  
lower premolar



**1002**  
Fig. 8  
lower premolars



## Section - 01



- ★ Extracting Forceps
- ★ Root Elevators



## Extracting Forceps “English Pattern”



**1003**  
Fig. 1  
upper centrals & canines



**1004**  
Fig. 2  
upper laterals & canines



**1005**  
Fig. 3  
upper incisors & canines



**1006**  
Fig. 4  
upper incisors & canines

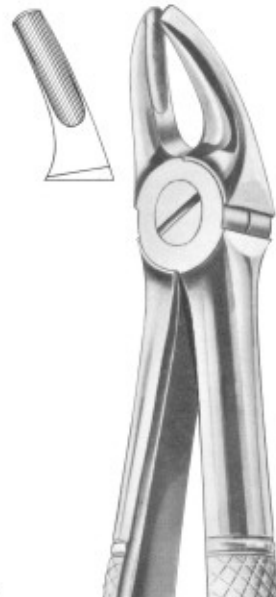

**1007**  
Fig. 7  
upper premolars



**1008**  
Fig. 8  
lower premolars



**1009**  
Fig. 13  
lower premolars





## Extracting Forceps "English Pattern"



**1010**  
Fig. 13S  
lower premolars  
for children.

**1011**  
Fig. 17  
upper molars, right

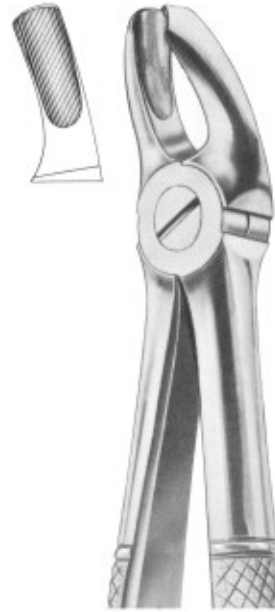

**1012**  
Fig. 18  
upper molars, left

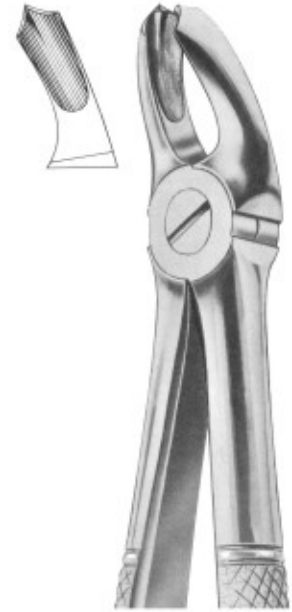

**1013**  
Fig. 18A  
upper molars



**1014**  
Fig. 18B  
upper molars



**1015**  
Fig. 19  
upper third molars



## Extracting Forceps "English Pattern"



**1016**  
Fig. 20  
upper third molars

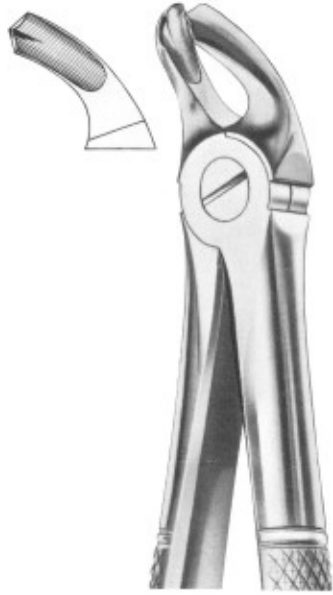

**1017**  
Fig. 21  
lower molars

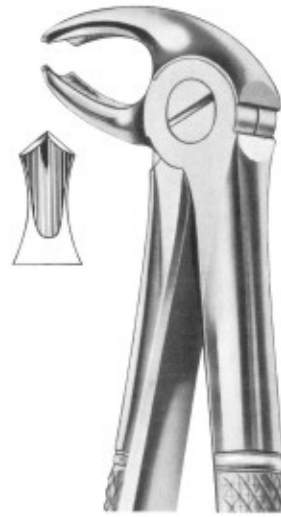

**1018**  
Fig. 22  
lower molars



**1019**  
Fig. 22S  
lower molars  
for children

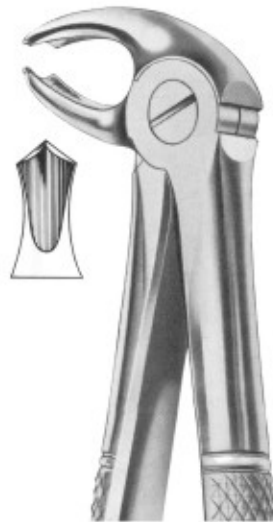

**1020**  
Fig. 22G  
lower molars



**1021**  
Fig. 23  
lower molars right



**1022**  
Fig. 24  
lower molars left





## Extracting Forceps “English Pattern”



**1023**  
Fig. 29  
upper roots



**1024**  
Fig. 29S  
upper roots for children



**1025**  
Fig. 30  
upper roots

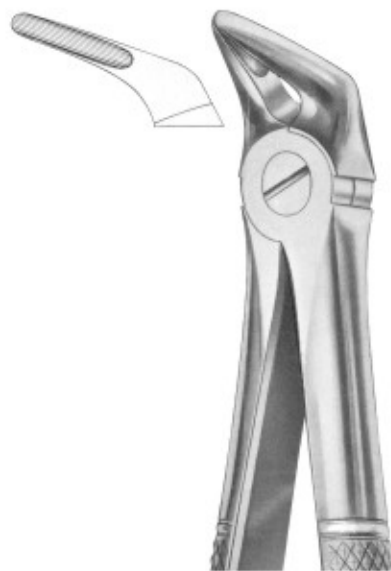

**1026**  
Fig. 31  
lower roots



**1027**  
Fig. 32  
lower molars



**1028**  
Fig. 30S  
upper roots  
for children



## Extracting Forceps "English Pattern"



**1029**  
Fig. 33  
lower roots



**1030**  
Fig. 33A  
lower roots



**1031**  
Fig. 33B  
lower roots



**1032**  
Fig. 33L  
lower roots



**1033**  
Fig. 37  
upper incisors  
for children



**1034**  
Fig. 33S  
lower roots  
for children





## Extracting Forceps "English Pattern"



**1035**  
Fig. 38  
lower incisors &  
canines for children



**1036**  
Fig. 39  
upper molars  
for children



**1037**  
Fig. 39R  
upper molars right  
for children



**1040**  
Fig. 39L  
upper molars left  
for children



**1038**  
Fig. 39A  
upper molars  
for children



**1039**  
Fig. 40  
lower molars  
for children



## Extracting Forceps "English Pattern"



**1041**  
Fig. 41  
upper roots

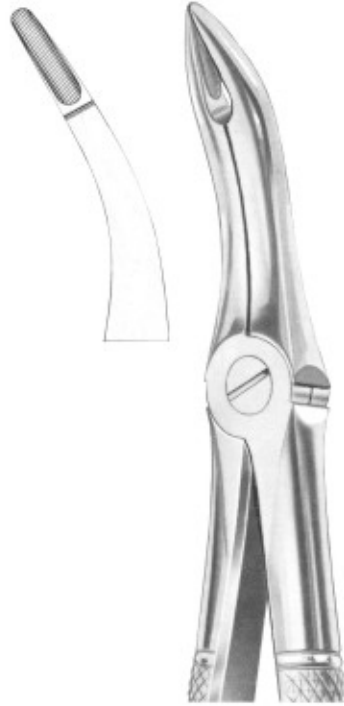

**1042**  
Fig. 44  
upper roots



**1043**  
Fig. 45  
lower roots

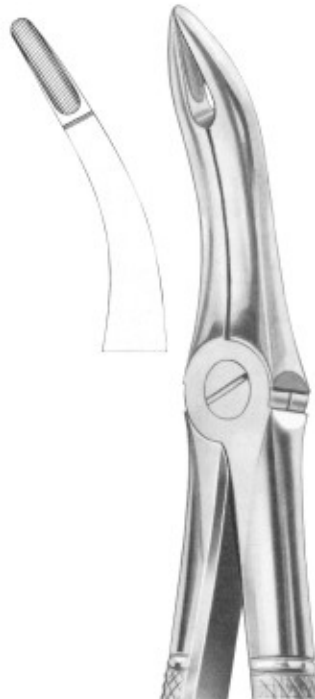

**1044**  
Fig. 48  
lower roots

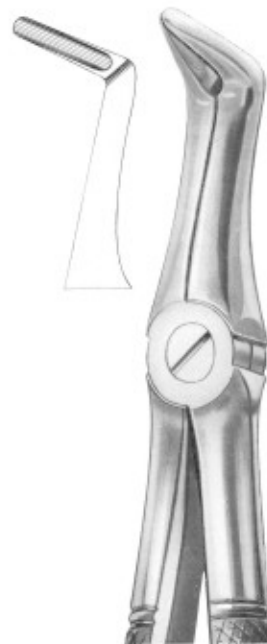

**1045**  
Fig. 49  
upper roots



**1046**  
Fig. 50  
upper roots





## Extracting Forceps “English Pattern”



**1047**  
Fig. 51  
upper roots



**1048**  
Fig. 51A  
upper roots



**1049**  
Fig. 51L  
upper roots



**1050**  
Fig. 52  
upper roots



**1051**  
Fig. 52A  
upper teeth  
and resection



**1052**  
Fig. 51S  
upper roots  
for children



## Extracting Forceps "English Pattern"



**1053**  
Fig. 54  
for separating  
upper molars



**1054**  
Fig. 55  
for separating  
upper molars



**1055**  
Fig. 56  
for separating  
lower molars

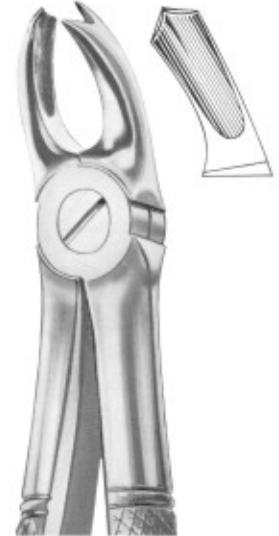

**1056**  
Fig. 65R  
upper molars  
right



**1057**  
Fig. 65L  
upper molars left



**1058**  
Fig. 67  
upper third molars

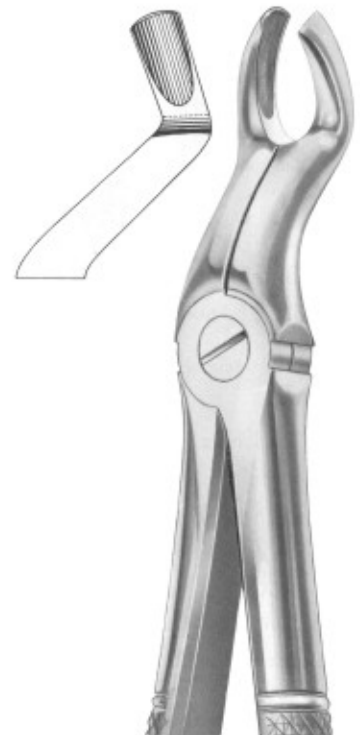

**1059**  
Fig. 67A  
upper third molars



# Burnishers



1870  
21 Acorn



1871  
Fig. 2-1B

1872  
Fig. 2-34



1873  
Fig. 2-1C

1874  
Fig. 2-6-28



1875  
Fig. 2-30

1876  
Fig. 2-6-30



1877  
Fig. 2-7-29

1878  
PKT 1



1879  
Fig. 2-7-30

1880  
PKT 2



1881  
Fig. 3-4T



1882  
Fig. 3

1883  
PKT 3



1884  
PFI 21

1885  
PKT 3P



1886  
Pitts Pado 19

1887  
PKT 4



1888  
Pitts Pado 18

1889  
PKT 5





# Wax Carvers



**1890**  
HOLLENBACK  
Fig. 3



**1891**  
HOLLENBACK  
Fig. 3S

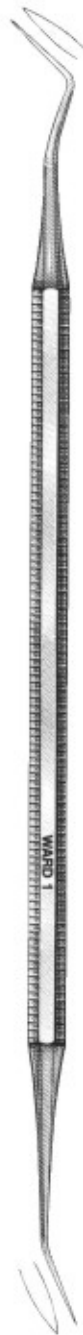

**1892**  
WARD  
Fig. 1



**1893**  
WARD  
Fig. 2

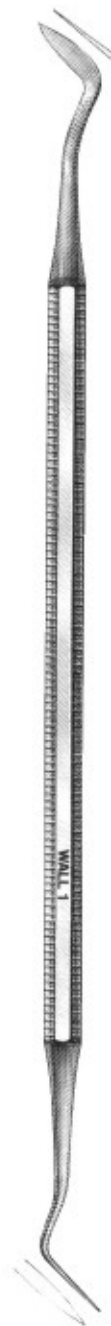

**1894**  
WALL  
Fig. 1



**1895**  
WALL  
Fig. 3



**1896**  
Fig. 3/6  
Cleoid/Discoïd



**1897**  
Fig. 89/92  
Cleoid/Discoïd



# Carvers



**1898**  
1.5mm Cleoid Discoid (Shown with GTX Finish)



**1899**  
2mm Cleoid Discoid



**1901**  
3mm Cleoid Discoid



**1900**  
GOLLOBIN  
Fig. 1



**1903**  
FRAHM  
Fig. 2-3 (off-angle)



**1902**  
HOLLENBACK  
Fig. 1/2



**1903**  
FRAHM  
Fig. 2-3 (off-angle)



**1904**  
HOLLENBACK  
Fig. 3



**1905**  
Interproximal 1



**1906**  
THOMPSON (Fig. 3)  
(1/2 Hollenback Hoe & Wall 3)



**1907**  
Interproximal 1



**1908**  
THOMPSON (Fig. 5)  
(1/2 Hollenback Hoe & Tanner 5)



**1909**  
Baum Interproximal



**1910**  
THOMPSON (Fig. 8)  
(3mm Cleoid & Wall 3)



**1911**  
Sho A Carver



**1912**  
THOMPSON (Fig. 9)  
(Hollenback 3 & Wall 3)



**1913**  
Thompson 2



**1914**  
WARD  
Fig. 2





# Carvers, Chisels



**1915**  
Composite Interproximal



**1916**  
TANNER  
Fig. 5



**1917**  
TANNER  
Fig. 6



**1920**  
University of Minnesota  
Fig. 1



**1921**  
University of Minnesota  
Fig. 2



**1918**  
THARP  
Fig. 1



**1919**  
THOMPSON  
Fig. 1



**1922**  
UPR  
Fig. 1



**1923**  
WALL  
Fig. 3

## Contour Carbide Carvers - Finishing



**1924**  
Contour Carbide (Fig. 1-2)



**1925**  
Cleoid Discoid



**1926**  
Contour Carbide (Fig. 10-11)

## Chisels



**1927**  
1.5mm Bin-Angle (15-8-8)



**1928**  
1.5mm Straight (15)



**1930**  
1.5mm Wedelstaedt (15-15-3)



**1929**  
1mm Wedelstaedt (10-15-3)



**1931**  
2mm Wedelstaedt (20-15-3)





# Composite Placement

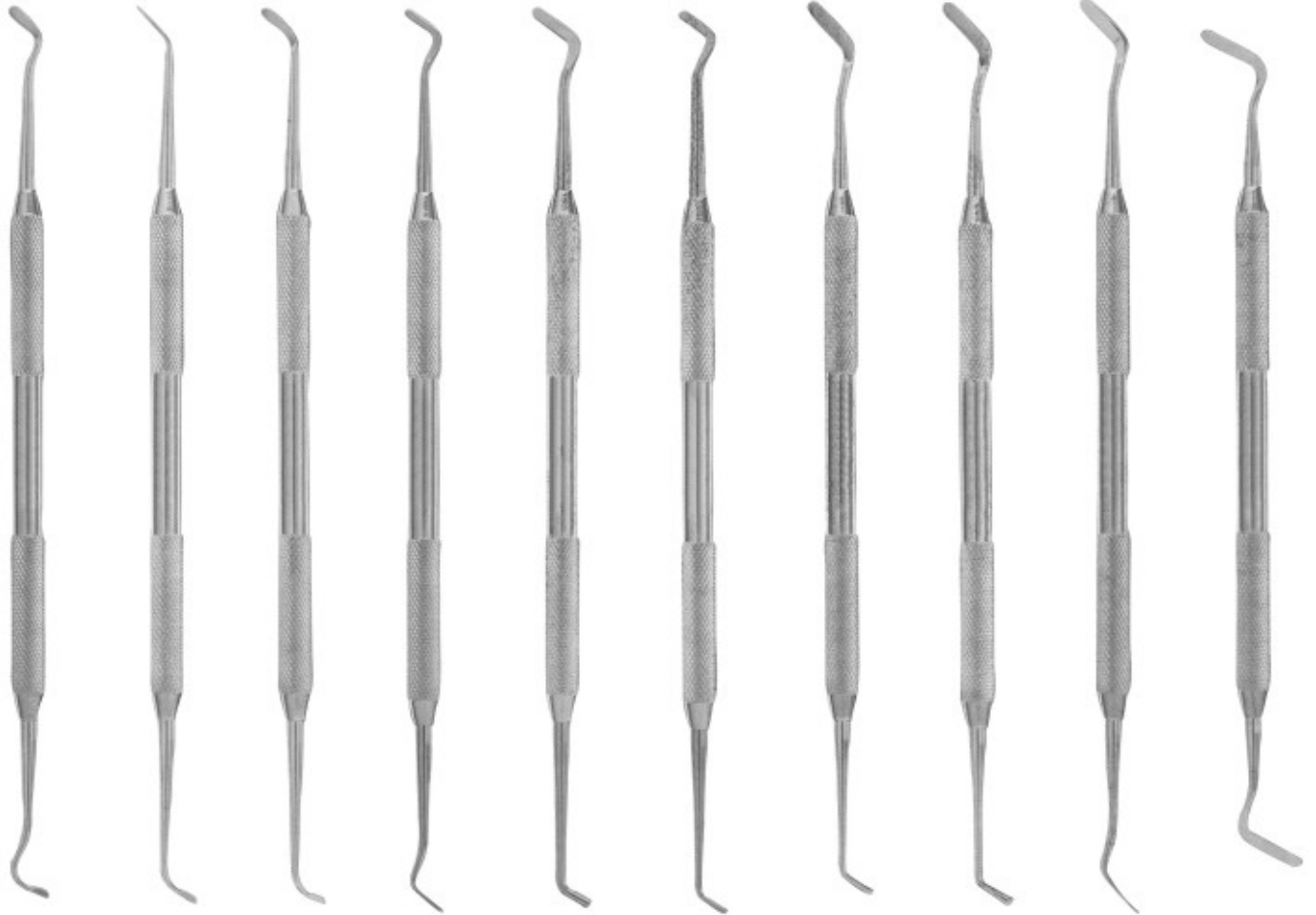

1932  
F-Type 1

1933  
F-Type 2

1934  
F-Type 3

1935  
F-Type 4

1936  
F-Type 5

1937  
F-Type 6

1938  
G-Type 1

1939  
G-Type 2

1940  
G-Type 3

1941  
G-Type 4

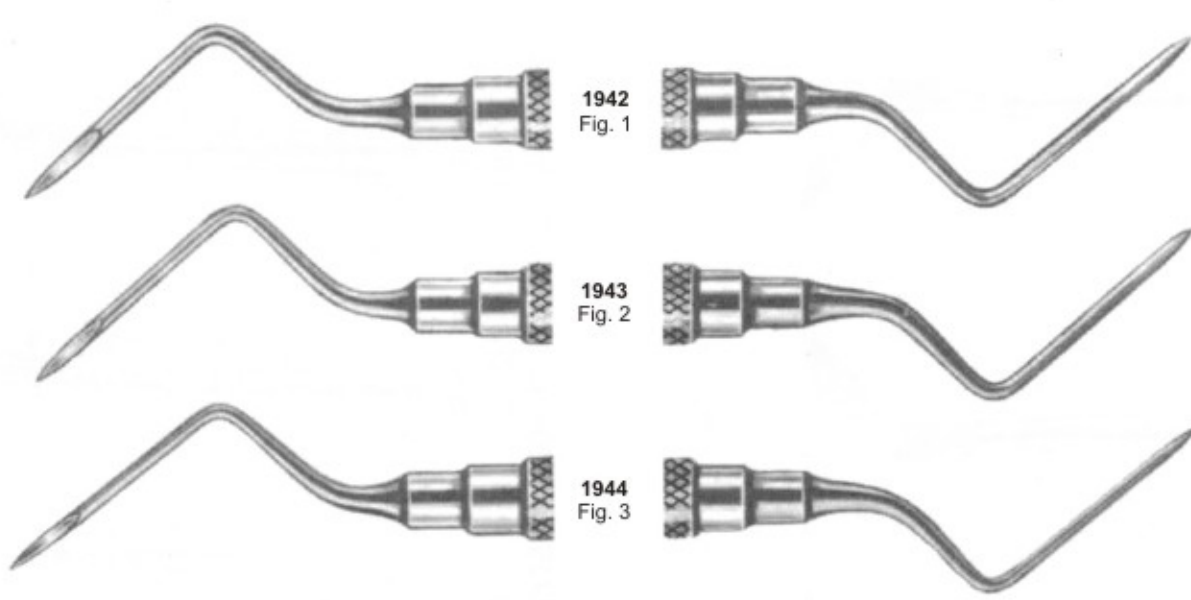

1942  
Fig. 1

1943  
Fig. 2

1944  
Fig. 3



# Composite Placement



1945  
Fig. 2



1946  
Fig. 3 (off-set blade)



1947  
Fig. 4



1948  
Fig. 5

1954  
Fig.12



1949  
Fig. 6



1950  
Fig.7



1951  
Fig.8

1955  
Fig.15



1952  
Fig.9



1953  
Fig.11



1956  
JORDAN  
Fig. 2



1957  
FREEDMAN  
Fig. 1



1958  
FREEDMAN  
Fig. 2



1959  
FREEDMAN  
Fig. 3



1960  
Dr. Dan



1961  
SIMON  
Fig. 2



## K - Type

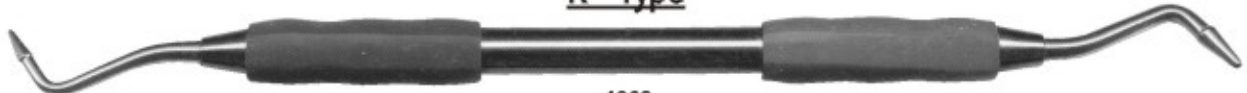

1962  
K-Type 1



1963  
K-Type 2



1965  
K-Type 4



1964  
K-Type 3



1966  
K-Type 5



1967  
K-Type 6 Carbide



## Plastic Filling Instruments

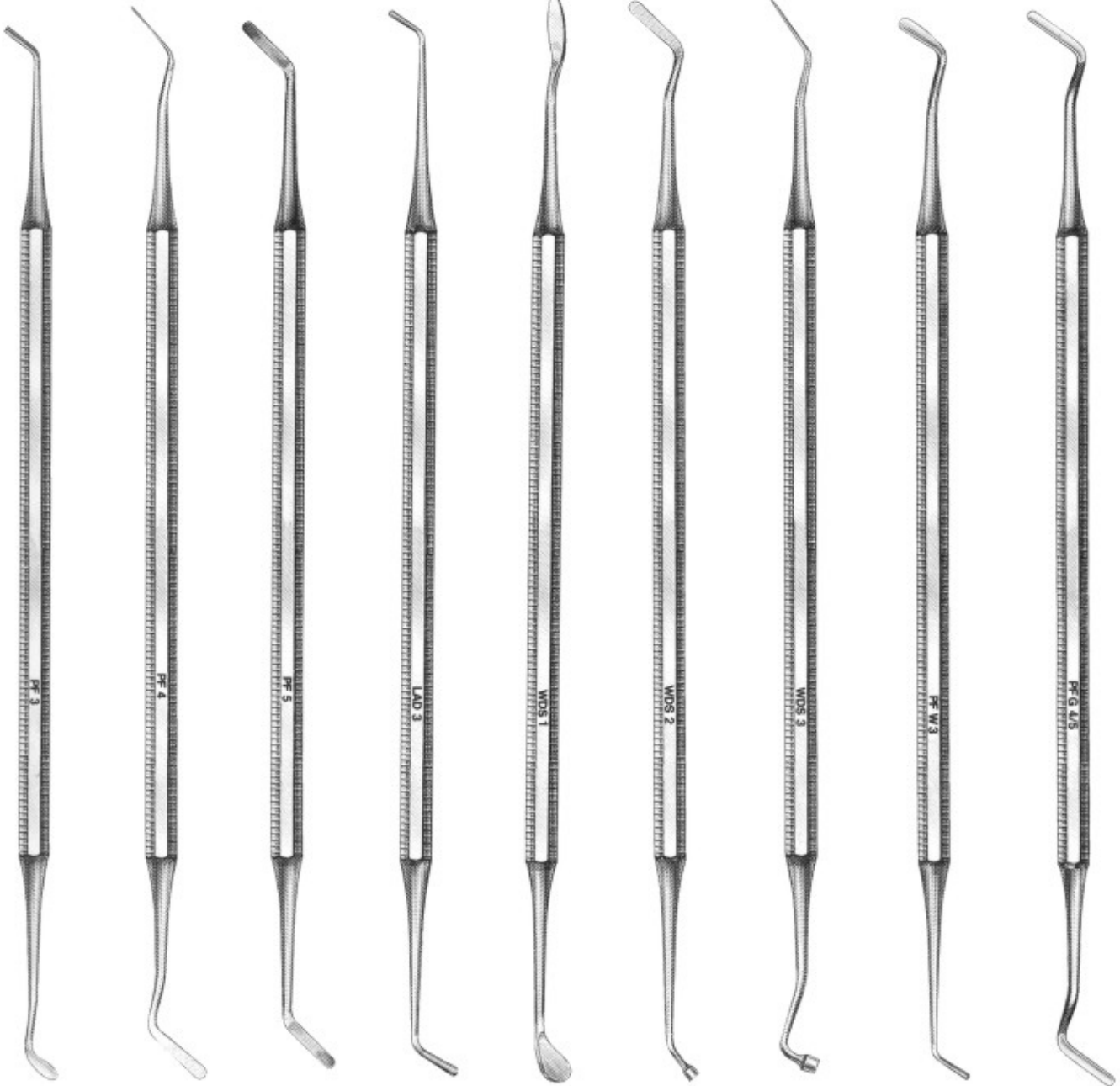

**1968**  
No.3

**1969**  
No.4

**1970**  
No.5

**1971**  
LADMORE  
Fig. 3

**1972**  
WOODSON  
Fig. 1

**1973**  
WOODSON  
Fig. 2

**1974**  
WOODSON  
Fig. 3

**1975**  
W-3

**1976**  
Gregg  
4/5





# Plastic Filling Instruments



1977  
Fig. 5-7



1978  
Fig.1



1979  
Fig. 3



1983  
GLICK  
Fig.1



1980  
Fig. 4



1984  
P8



1981  
Fig. 5-7



1985  
WOODSON  
Fig. 1



1982  
Fig. 8A



1986  
WOODSON  
Fig. 2



1987  
WOODSON  
Fig. 3





## Curettes



**1988**  
GRACEY  
GC 1-2



**1989**  
GRACEY  
GC 3-4



**1990**  
GRACEY  
GC 5-6



**1991**  
GRACEY  
GC 7-8

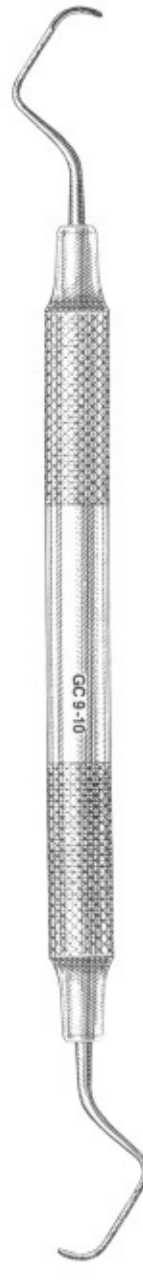

**1992**  
GRACEY  
GC 9-10



**1993**  
GRACEY  
GC 11-12



**1994**  
GRACEY  
GC 13-14



## Gracey Curettes



**1995**  
G1-2



**1996**  
G3-4



**1997**  
G5-6



**1998**  
G7-8

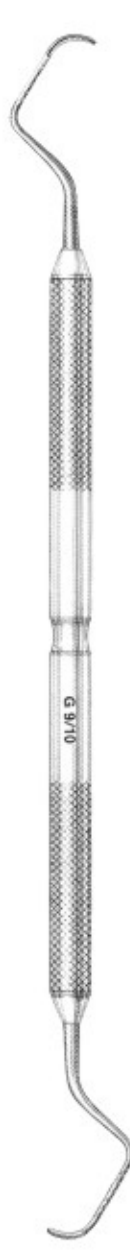

**1999**  
G9-10



**2000**  
G11-12

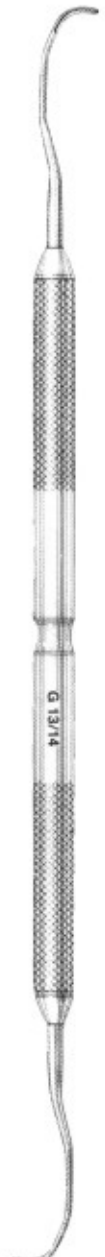

**2001**  
G13-14





## Extracting Forceps "English Pattern"



**1060**  
Fig. 67 1/2R  
upper third molars  
right



**1061**  
Fig. 67 1/2L  
upper third molars  
left



**1062**  
Fig. 68  
lower roots



**1063**  
Fig. 68A  
lower roots



**1064**  
Fig. 73  
lower molars



**1065**  
Fig. 73R  
lower molars right



**1066**  
Fig. 73L  
lower molars left



## Curettes # 4 Handle

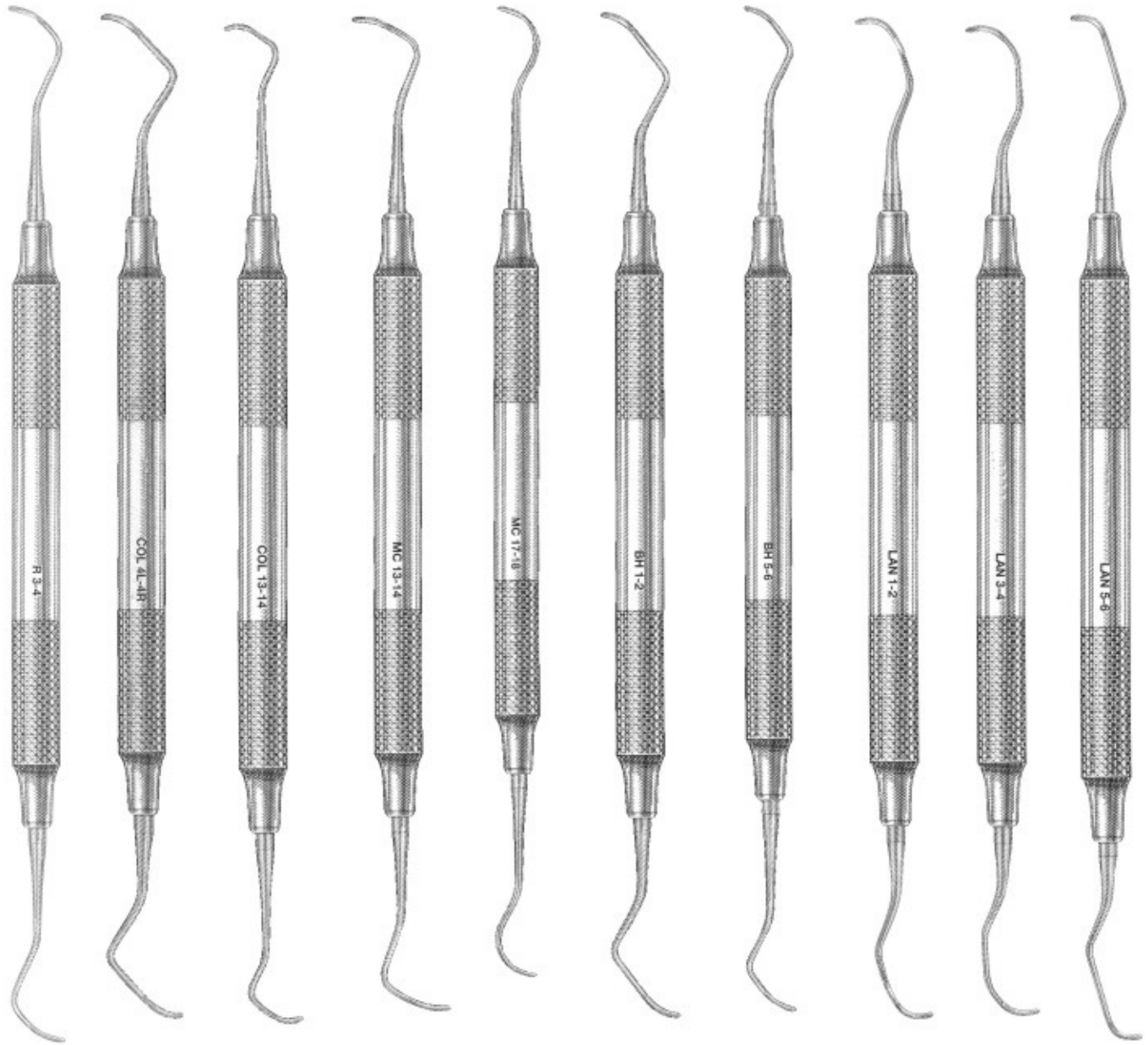

**2002**  
RULE  
3-4

**2003**  
COLUMBIA  
4R-4L

**2004**  
COLUMBIA  
13-14

**2005**  
MCCALLS  
13-14

**2006**  
MCCALLS  
17-18

**2007**  
BARNHART  
1-2

**2008**  
BARNHART  
5-6

**2009**  
LANGER  
1-2

**2010**  
LANGER  
3-4

**2011**  
LANGER  
5-6



## Curettes

### COLUMBIA CURETTES



2012  
4L-4R

2013  
13-14

2014  
2L-2R

### MCCALLS CURETTES



2015  
13-14

2016  
13S-14S

2017  
17-18

2018  
17S-18S





## Curettes

### GOLDMAN FOX



**2019**  
GF1 Universal Scaler



**2020**  
GF2 Curette



**2021**  
GF3 Curette



**2022**  
GF4 Curette



**2023**  
GF5 Hoe



**2024**  
GF6 Hoe



## Curettes

### GOLDMAN FOX



**2025**  
GF 7 Knife



**2026**  
GF 8 Spear Knife

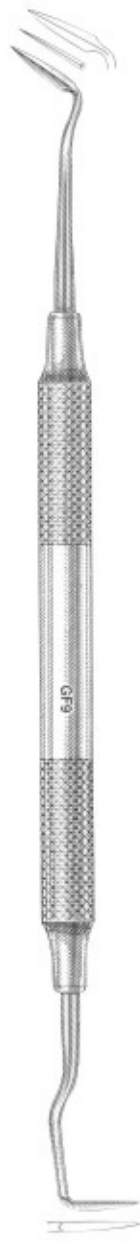

**2027**  
GF 9 Knife Scaler

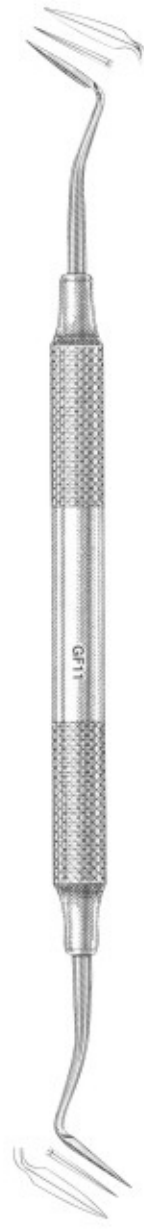

**2028**  
GF 11 Spear Knife



**2029**  
GF 21 Sharp Spoon /  
Small Scaler



## Knives, Interproximal Files



**2030**  
Kirkland 15 / 16



**2031**  
Ordan 1 / 2

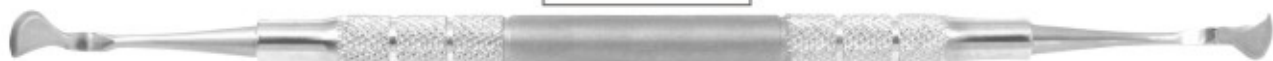

**2032**  
Buck 3 / 4

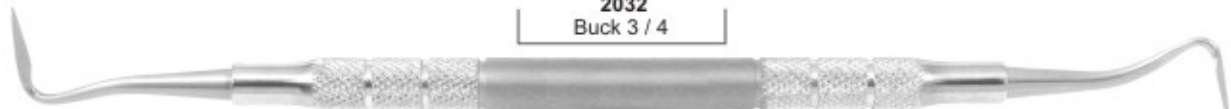

**2033**  
Buck 5 / 6



**2034**  
Goldman-Fox 7



**2035**  
Goldman-Fox 8



**2036**  
Goldman-Fox 9



**2037**  
Goldman-Fox 11



**2038**  
CK 3 (Crane)

### Interproximal Files

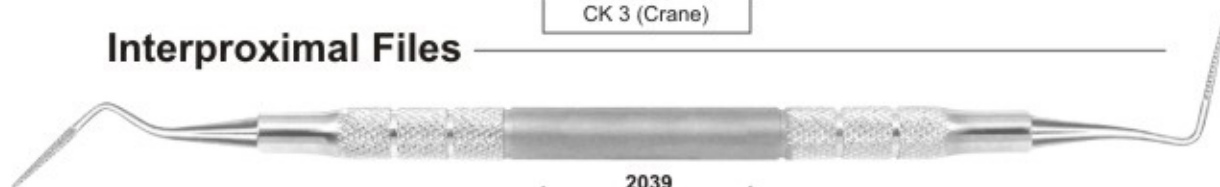

**2039**  
Sugarman 1S-2S

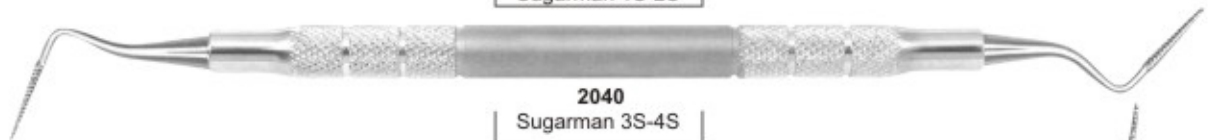

**2040**  
Sugarman 3S-4S

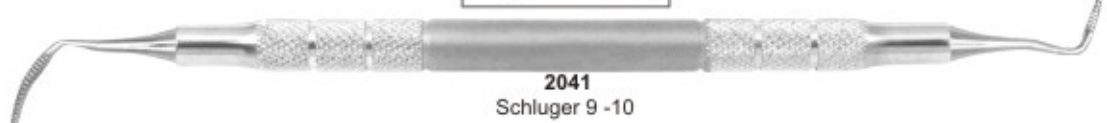

**2041**  
Schluger 9 -10



**2042**  
Buck 11 - 12





## Curettes, Root Planning Curettes



**2043**  
COLUMBIA (2L-2R)



**2044**  
MCCALL (13-14)



**2045**  
MCCALL (17S-18S)

### Root Planning Curettes



**2046**  
Root Plane (1-2)



**2047**  
Root Plane (5-6)

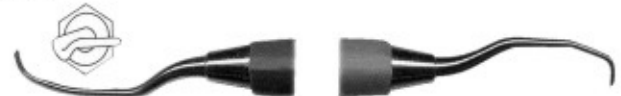

**2049**  
Root Plane (11-12)



**2048**  
Root Plane (7-8)

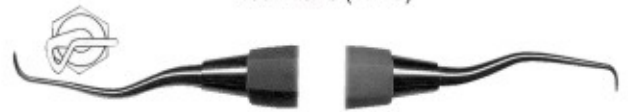

**2050**  
Root Plane (13-14)



**2051**  
Petite (1-2)



**2052**  
Petite (11-12)



**2053**  
Petite (5-6)

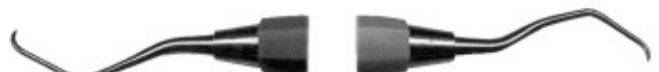

**2054**  
Petite (13-14)



# Curettes



2055  
BARNHART (1-2)



2056  
BARNHART (5-6)



2065  
COLUMBIA (4L-4R)

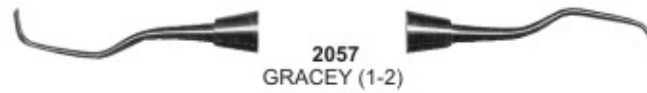

2057  
GRACEY (1-2)

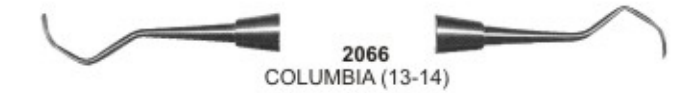

2066  
COLUMBIA (13-14)



2058  
GRACEY (3-4)



2067  
LANGER (1-2)

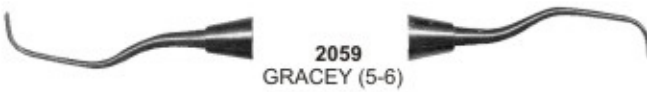

2059  
GRACEY (5-6)



2068  
LANGER (3-4)



2060  
GRACEY (7-8)



2069  
LANGER (5-6)



2061  
GRACEY (9-10)



2070  
MCCALL (13-14)



2062  
GRACEY (11-12)



2071  
MCCALL (13S-14S)



2063  
GRACEY (13-14)



2072  
MCCALL (17-18)



2064  
GRACEY (2L-2R)



2073  
MCCALL (17S-18S)



2074  
RULE (3-4)



# Dental Products



Silicon Handles-Reusable

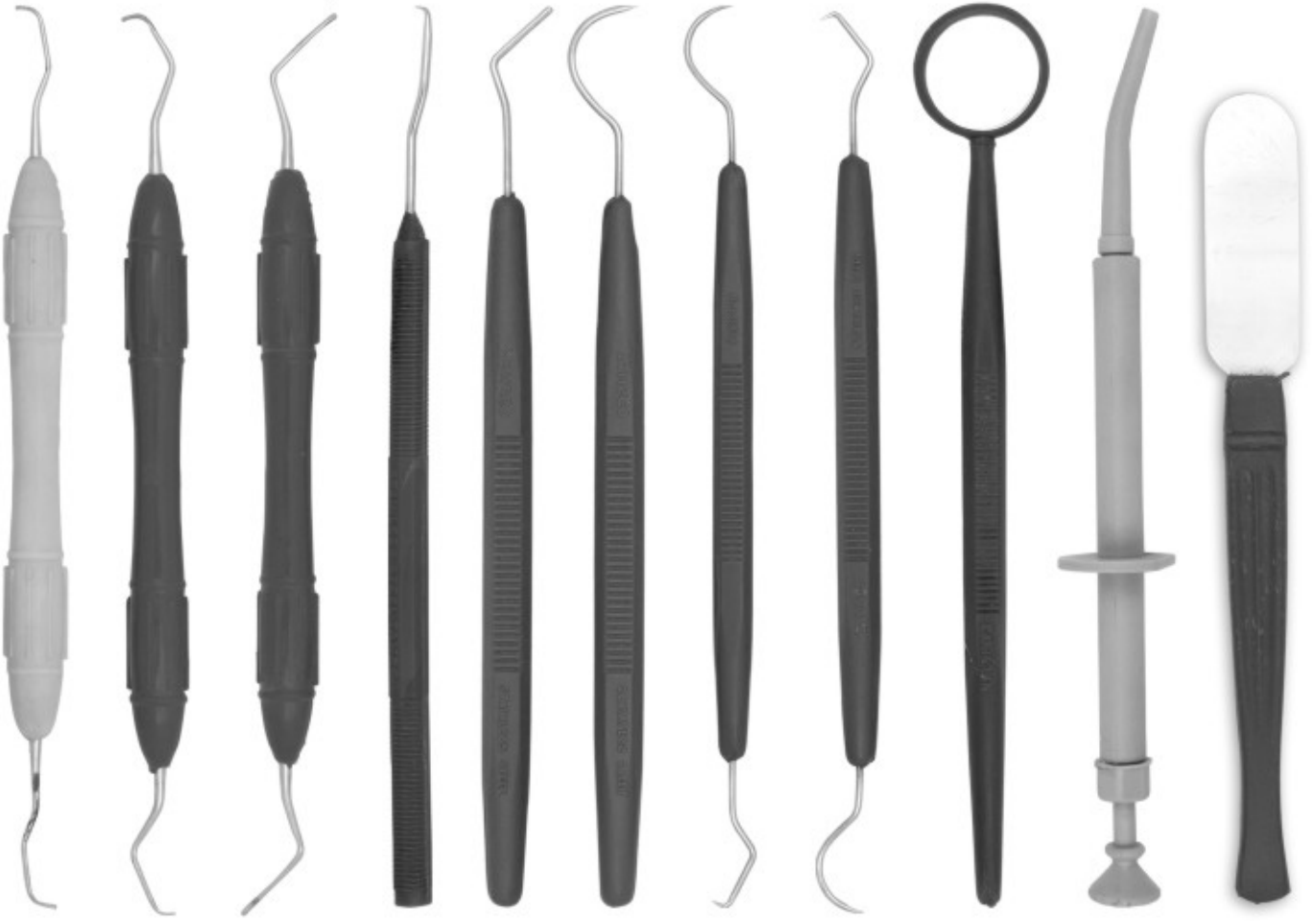

2075

2076

2077

2078

2079

2080

2081

2082

2083

2084

2085



2086



2087



2088



2089



2090





Comfort Grip  
Vinyl - Covered Insulating Handles

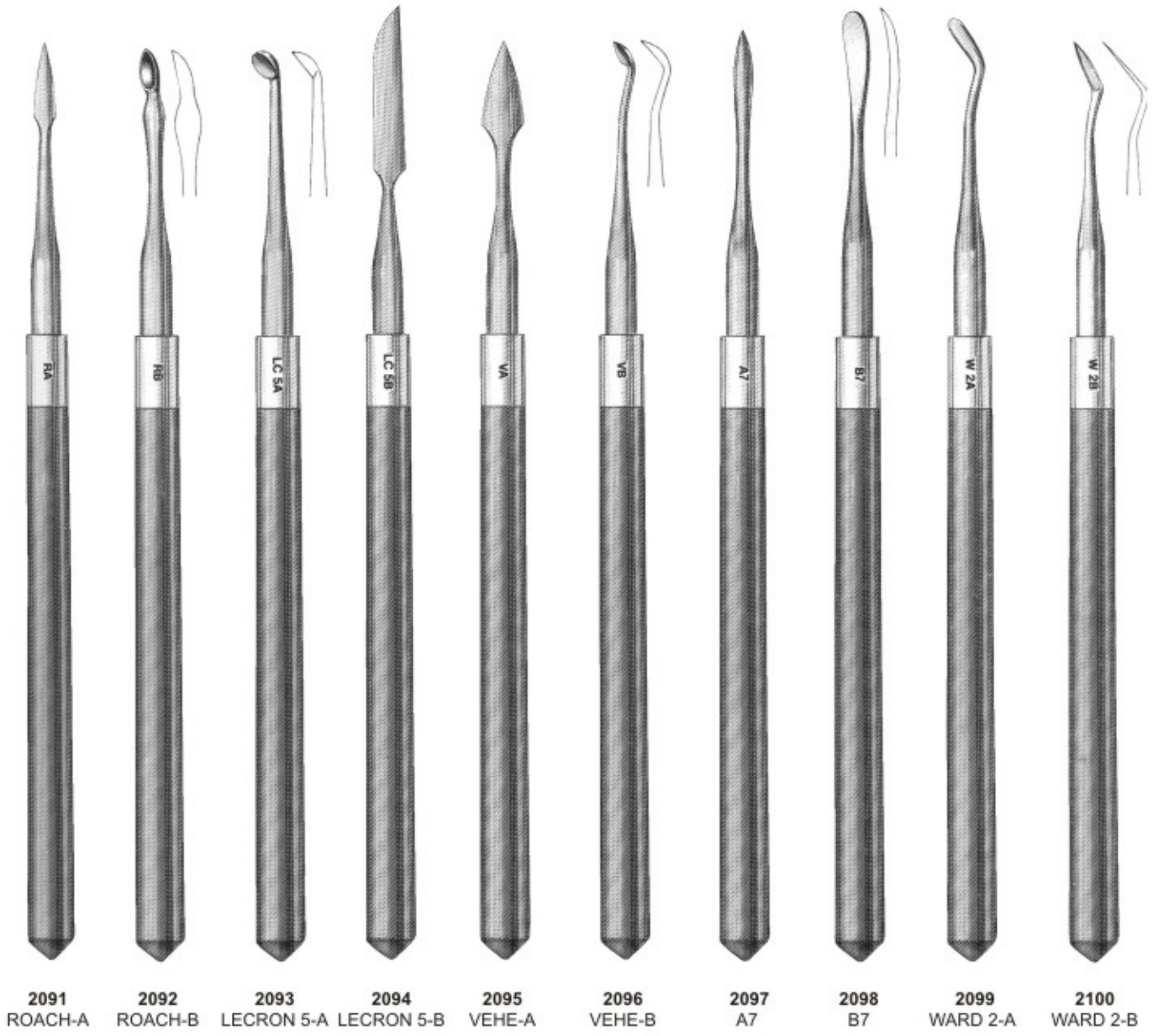



# Wax, Porcelain & Cement Instruments



## P.K. THOMAS

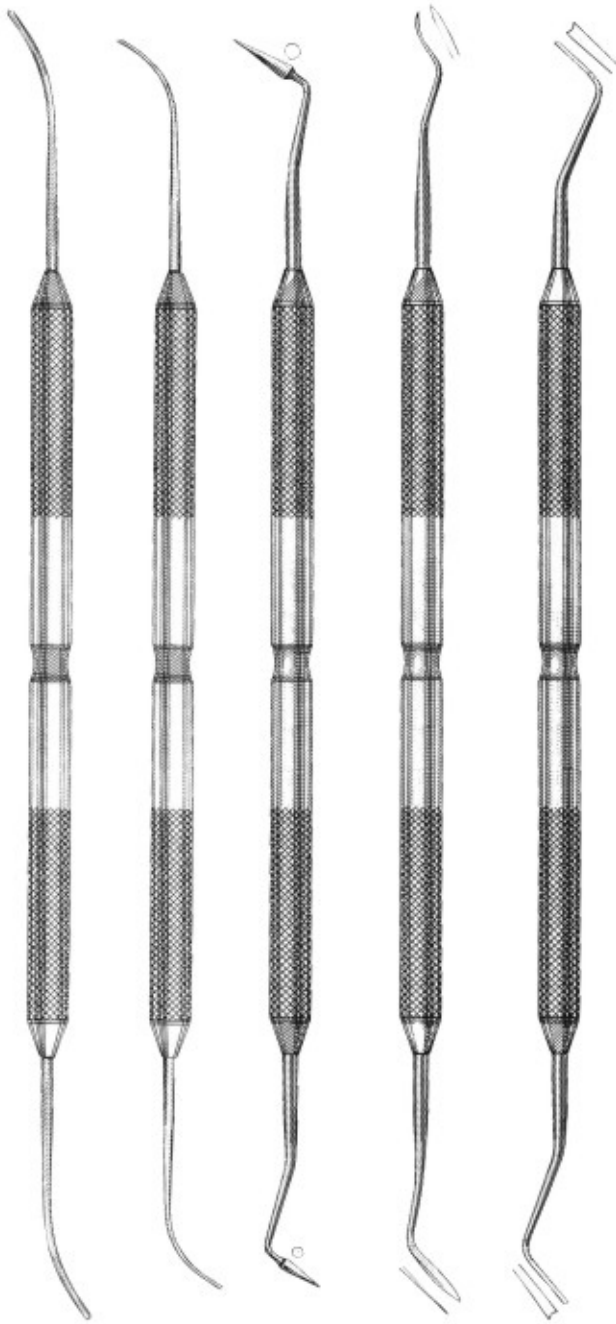

2101  
PKT 1

2102  
PKT 2

2103  
PKT 3

2104  
PKT 4

2105  
PKT 5

Set of 5 instruments

## WAX CARVERS

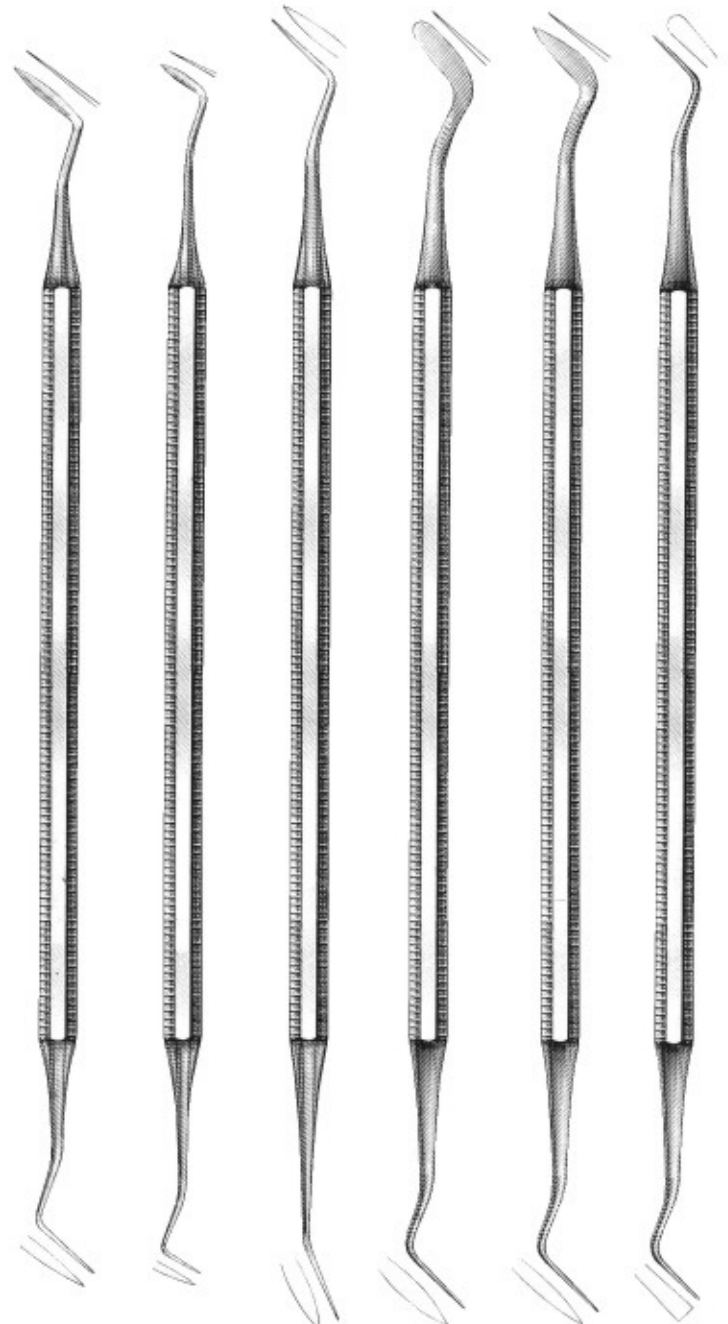

2106  
Hollenback 3

2107  
Hollenback 3S

2108  
WARD 1

2109  
WARD 2

2110  
WALL 1

2111  
WALL 3



## Extracting Forceps “English Pattern”



**1067**  
Fig. 73A  
lower molars



**1068**  
Fig. 73S  
lower molars



**1069**  
Fig. 73B  
lower molars for children



**1072**  
Fig. 73K  
lower molars  
for children



**1070**  
Fig. 74  
lower roots



**1071**  
Fig. 74D  
lower roots





# Wax & Modeling Carvers, Cement Spatulas

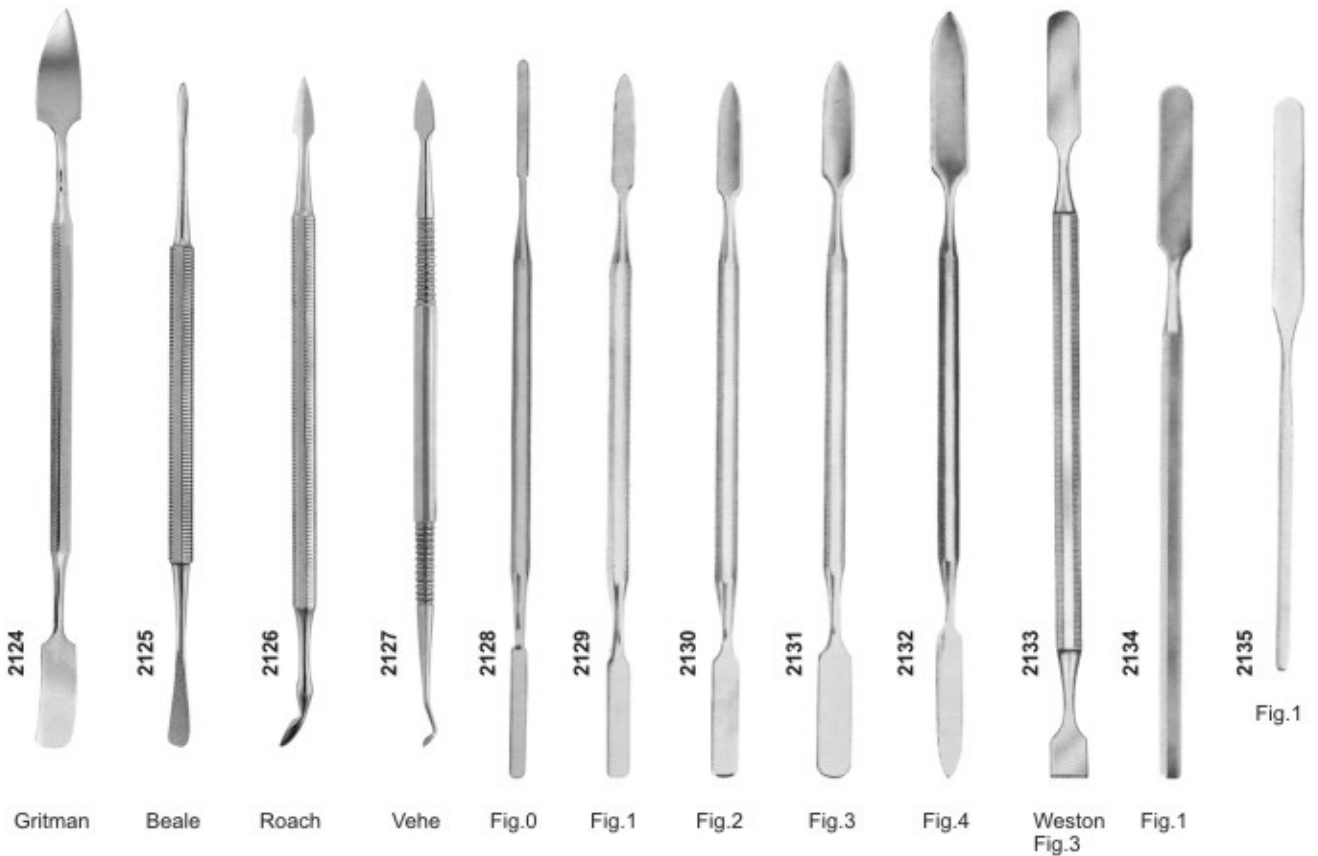
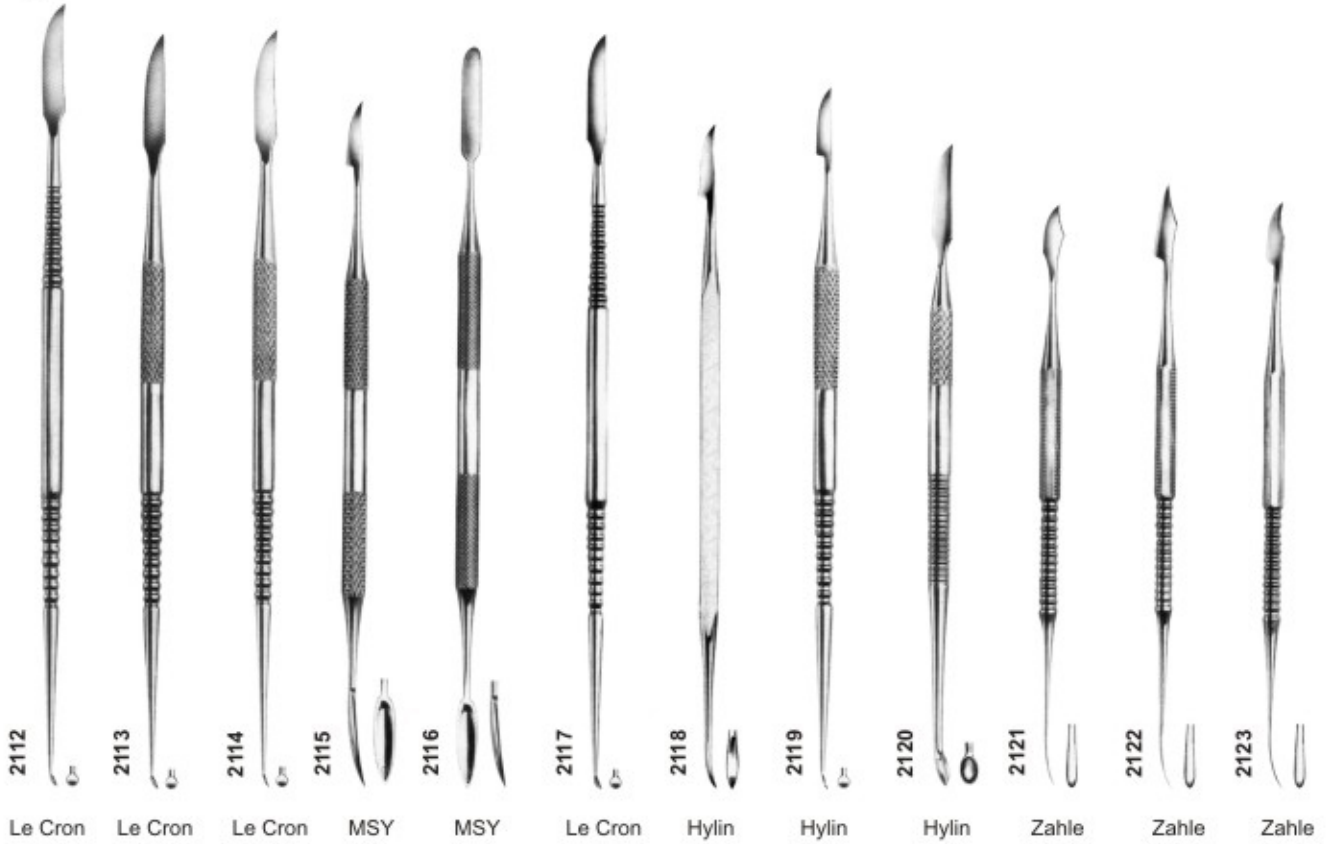



## WAX & PORCELAIN CARVERS

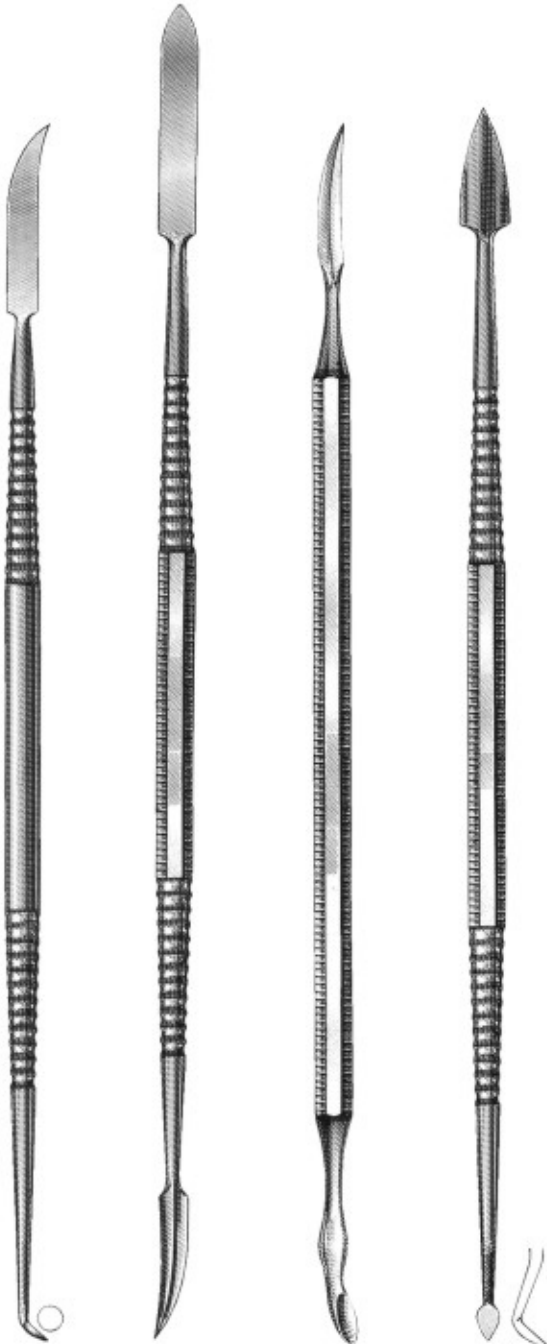

2136  
LECRON  
Inlay

2137  
REEVES

2138  
VEHE  
Wax

2139  
ROACH  
Wax

## WAX SPATULAS

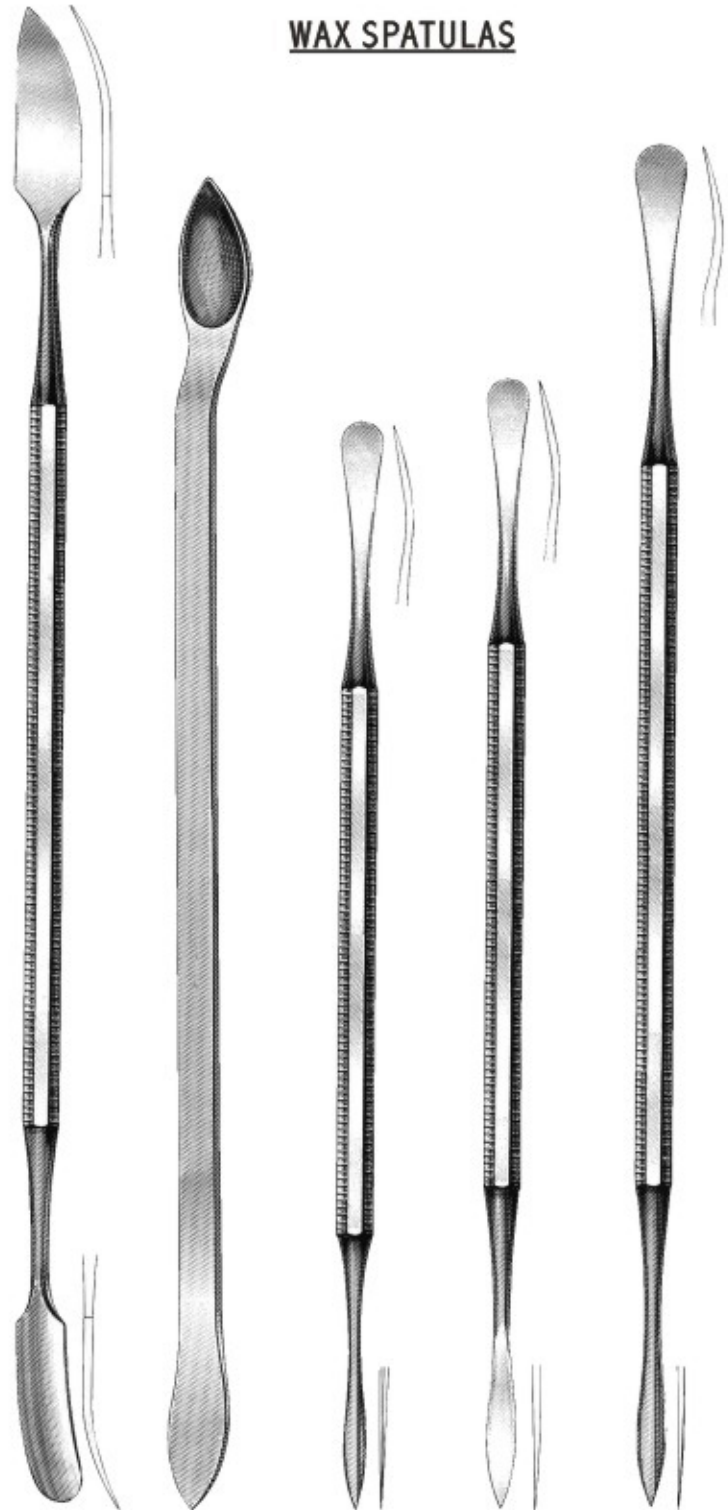

2140  
W-31

2141  
W-5

2142  
W-7

2143  
W-7A

2144  
W-7G



# Cement Spatulas



2145  
AGATHE



2146  
C-7



2147  
C-5



2148  
C-313



2149  
C-24A Rigid



2150  
C-24 Flexible



2151  
C-24 Flexible



2152  
24



2153  
A6



2154  
7 Wax



2155  
26



2156  
All Metal Spatulas with High Polish  
Stainless Steel Blade



2157  
31





# Spatulas





# Spatulas

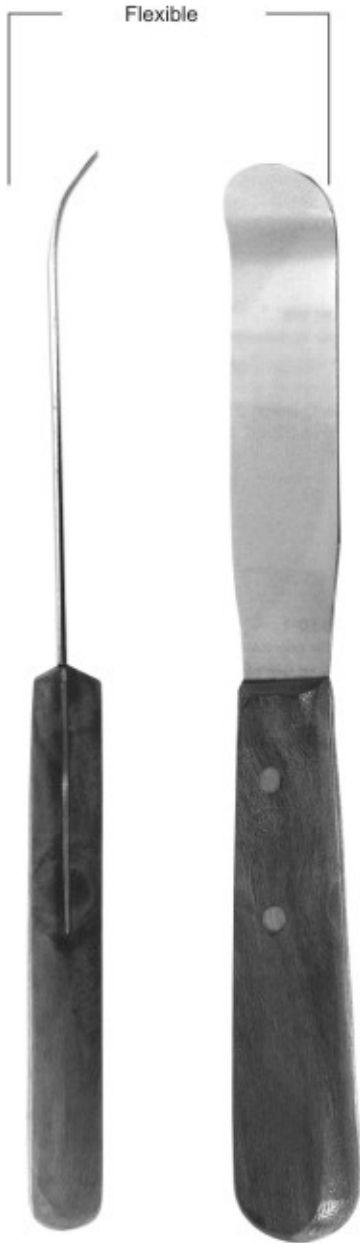

2164  
Fig. 7  
19.5 cm



2165  
Fig. 8  
20 cm

2166  
Fig. 9  
22.5 cm



# Files, Hoes & Knives



## FILES



2167  
Hirshfeld 3-7



2168  
Hirshfeld 5-11



2169  
Hirshfeld 9-10

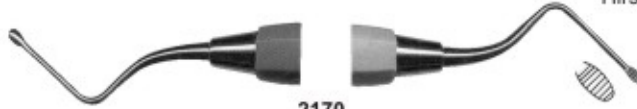

2170  
Orban 10-11

## HOES



2171  
Orban 6-7

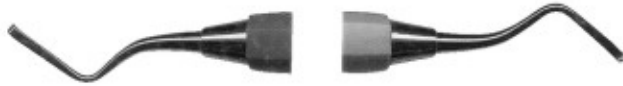

2172  
Orban 8-9



2173  
UWH 18-19



2174  
UWH 16-18



2175  
UWH 20-21



2176

## KNIVES

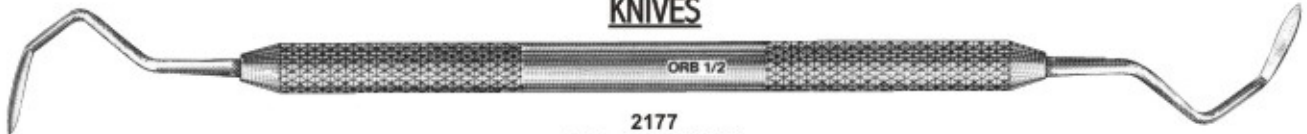

2177  
Orban Knife (1-2)



2178  
1 SE



2179  
2-3



2180  
Kirkland 13-13L



2181  
Knife Orban 1-2 TT DEO





## Wax Knives



**2182**  
Fahnenstock  
Fig. 1  
12,5cm



**2183**  
Fahnenstock  
Fig. 2  
17cm



**2184**  
Lessmann  
Fig. 1  
12,5cm



**2185**  
Lessmann  
Fig. 2  
17cm



**2186**  
Con scodellino  
Fig. 1  
12,5cm



**2187**  
Con scodellino  
Fig. 2  
17cm



**2188**  
Ermert



**2189**  
Ermert



## Wax Knives & Plaster Knives



**2190**  
18 cm  
7 1/8"



**2191**  
18 cm  
7 1/8"



**2192**  
17 cm  
6 3/4"  
Gritman



**2193**  
17 cm  
6 3/4"  
Medicon



**2194**  
Fig. 1  
17 cm



**2195**  
22 cm  
8 3/4"



**2196**  
22 cm  
8 3/4"



**2197**  
Gritman  
Fig. 2  
17 cm



**2198**  
Fig. 3  
16 cm



**2199**  
Fig. 4  
16 cm



# Crane-Kaplan, Chisels



## CRANE-KAPLAN



**2200**  
Ck1  
Pocket Marker



**2201**  
Ck2  
Pocket Marker



**2202**  
Knife



**2203**  
Dissector



**2204**  
Scaler

## OCHSENBEIN



**2205**  
Ochsenbein  
Fig. 1



**2206**  
Ochsenbein  
Fig. 2



**2207**  
Ochsenbein  
Fig. 4

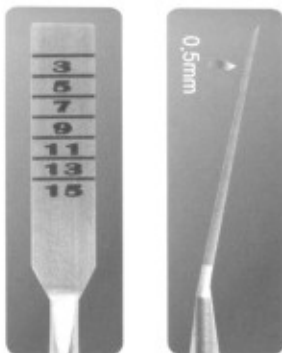

Split Chisel Set



**2208**  
Split Chisel  
6 mm Curved



**2209**  
Split Chisel  
6 mm Straight



**2210**  
Split Chisel  
4 mm Curved



**2211**  
Split Chisel  
4 mm Straight





# Bone Currettes



**2212**  
No. 1



**2213**  
No. 2



**2214**  
No. 4



**2215**  
No. 5L



**2216**  
No. 6R



**2217**  
No. 75



**2218**  
No. 2/4



**2219-A**  
Miller  
11 cm



**2219-B**  
Lucas  
CL 84



**2219-C**  
Lucas  
CL 85

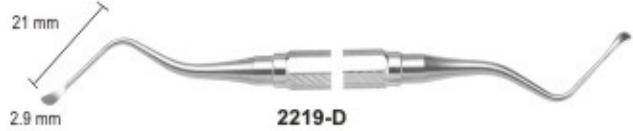

**2219-D**  
Lucas  
CL 86

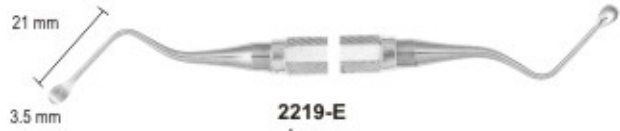

**2219-E**  
Lucas  
CL 87



**2219-F**  
Lucas  
CL 88

**100% actual size**

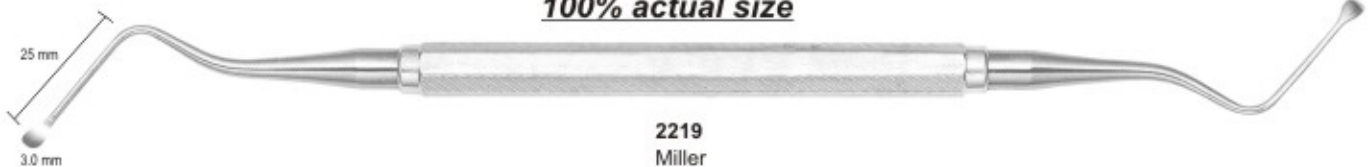

**2219**  
Miller  
10 cm



## Extracting Forceps “English Pattern”



**1073**  
Fig. 74M  
lower roots



**1074**  
Fig. 74N  
lower roots



**1075**  
Fig. 74XN  
lower roots and  
crowded incisors



**1078**  
Fig. 76N  
upper roots



**1076**  
Fig. 75  
lower premolars



**1077**  
Fig. 76  
upper roots



# Bone Files

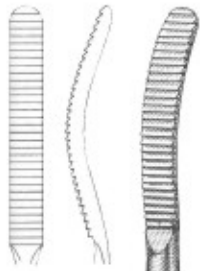

**2220**  
No. 10

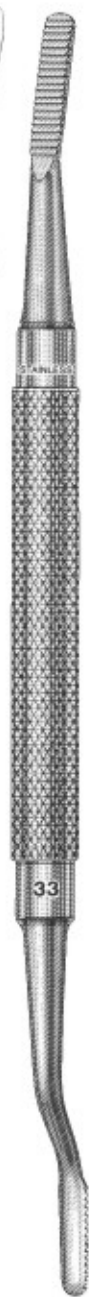
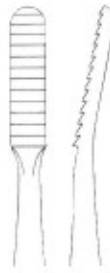

**2221**  
No. 33

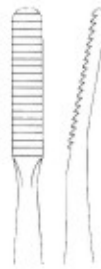

**2222**  
MILLER  
No. 33

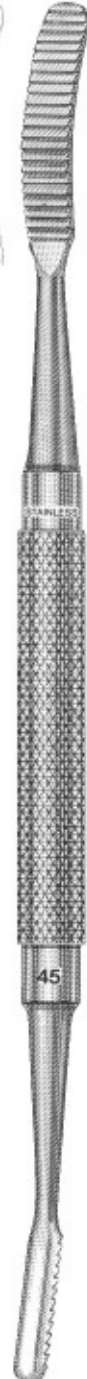
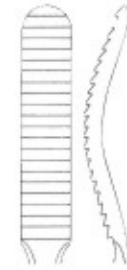

**2223**  
MILLER  
No. 64

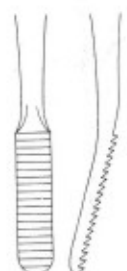
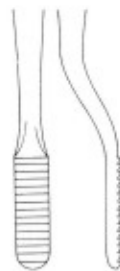
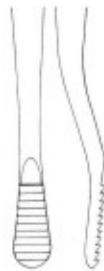





## Bone Files

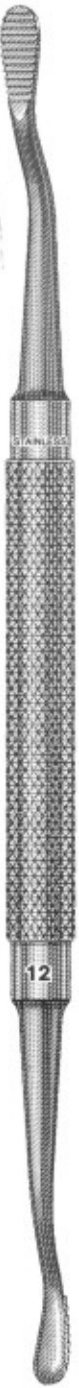

**2224**  
HOWARD  
No. 12



**2225**  
HOWARD  
No. 12A



**2226**  
HOWARD  
No. 12CA



**2227**  
POLOKOFF  
No. 1



## Bone Chisels

### GARDNER



**2228**  
GARDNER  
No. 1

**2229**  
GARDNER  
No. 2

**2230**  
GARDNER  
No. 5

**2231**  
GARDNER  
No. 5R

### WAKEFIELD



**2232**  
WAKEFIELD  
No. 1W

**2233**  
WAKEFIELD  
No. 2W



# Bone Chisels, Bone Mallets



## Bone Chisels and Gouges

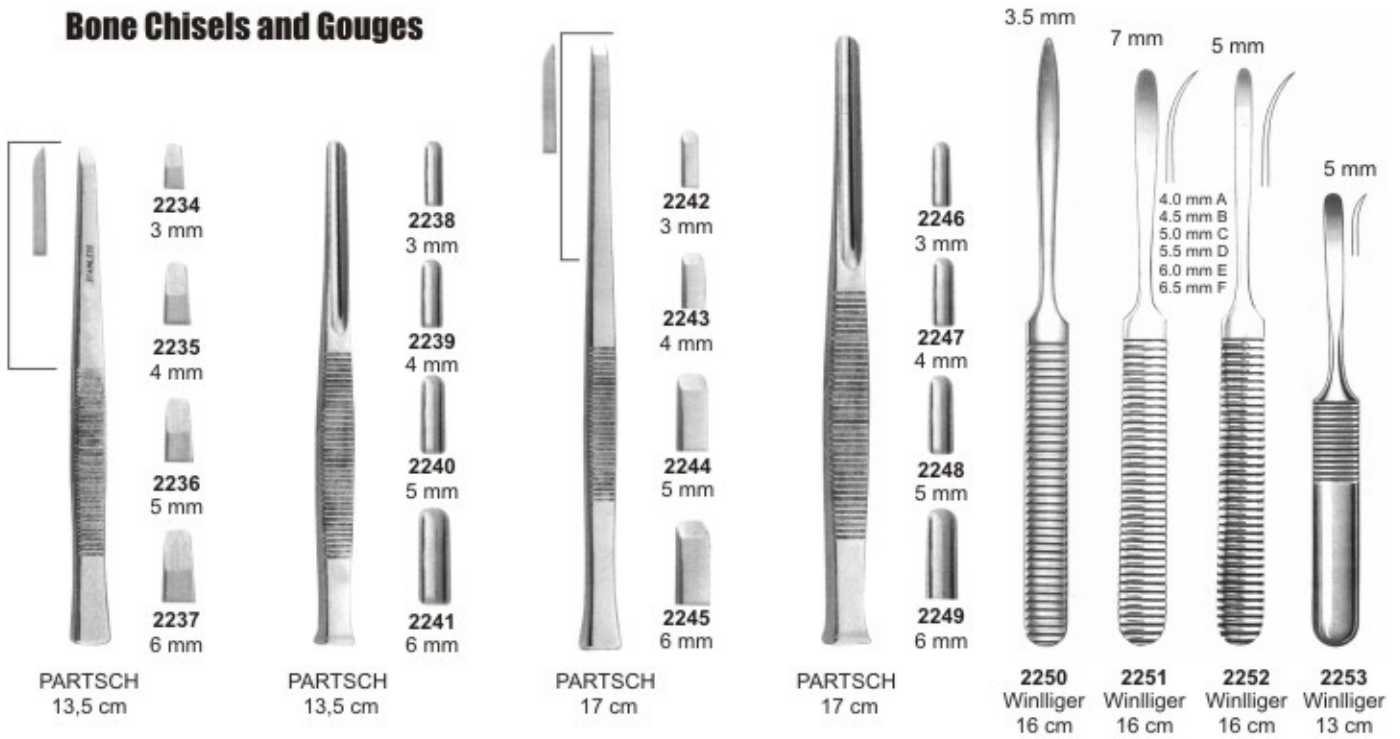

## Martelli chirurgici Mallet

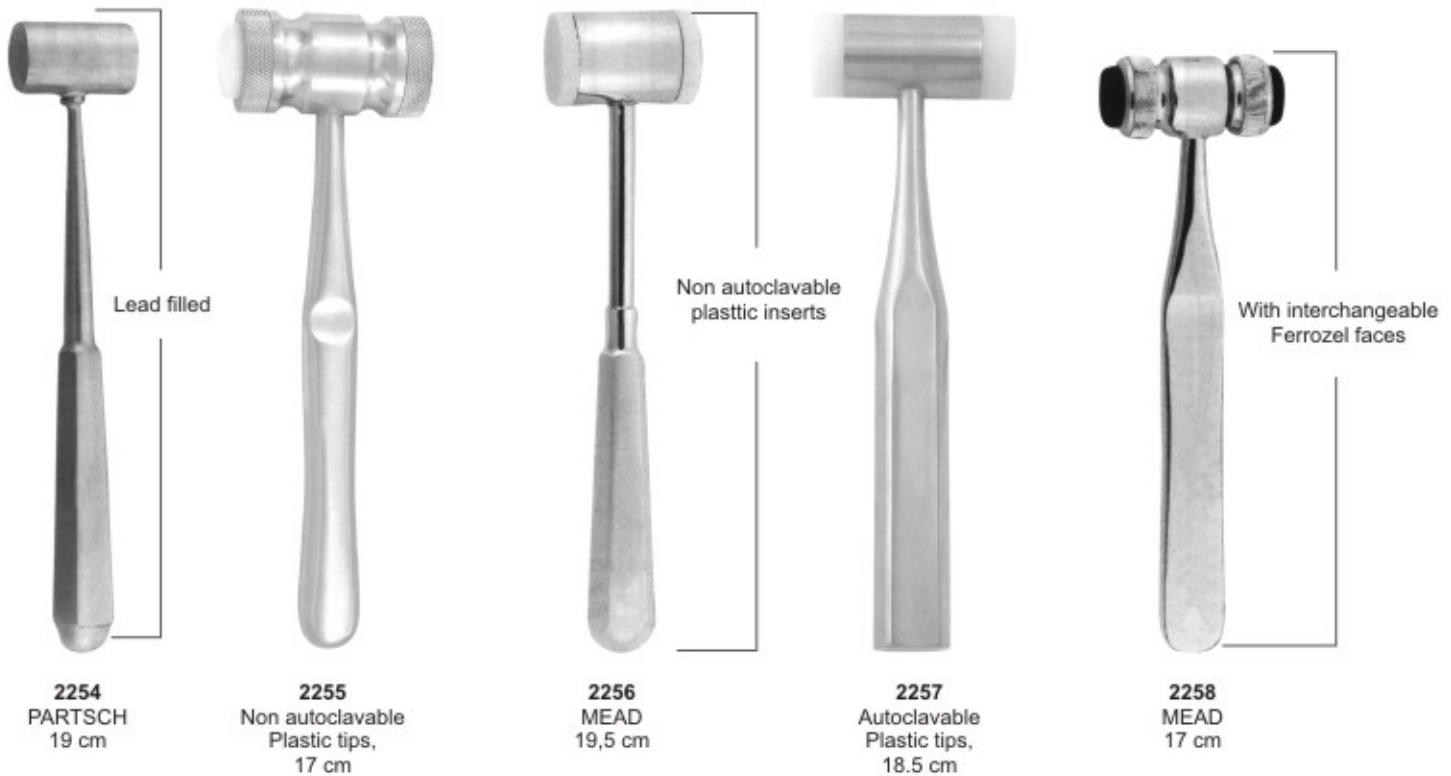





# Crown Removers

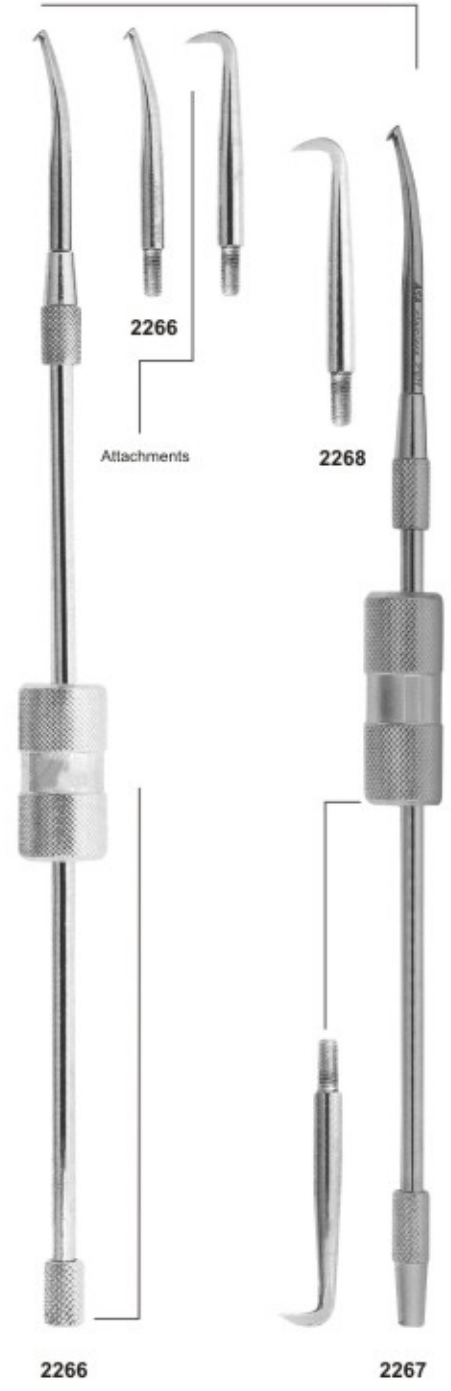



# Crown Instruments



Fig.3

**2269**  
Crown Remover

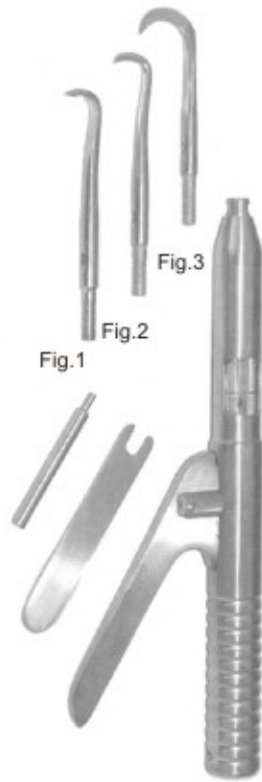

Fig.1

Fig.2

Fig.3

**2270**  
Crown Remover



**2271**  
single loop  
with adapter



2272

2273

KEY/9 ADAPTER/8

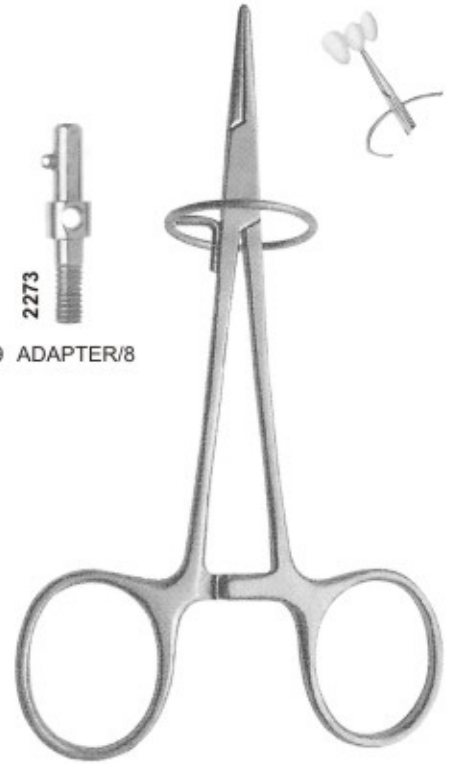

**2274**  
Crown & Bridge Holding Forceps  
With Support Ring



**2275**  
WYNMAN  
Crown Gripper, CARB-N-SERT

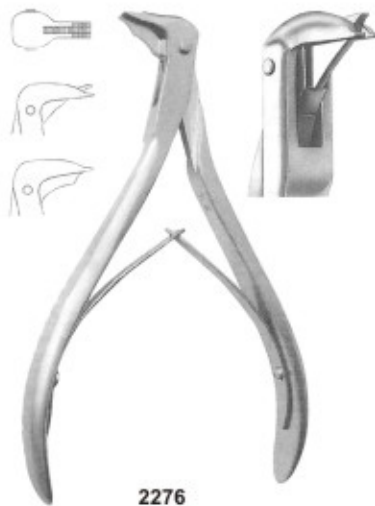

**2276**  
Crown opener

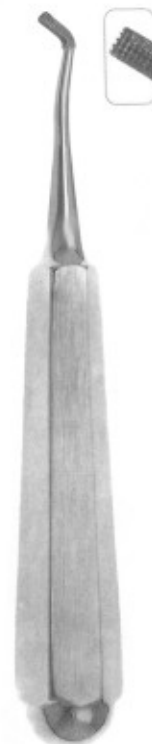

**2277**  
Mershon  
14.5 cm/5 7/8"



**2278**  
Universal  
Hollow Handle



**2279**  
Fig.2

**2280**  
Fig.3

**2281**  
Fig.4





## Crown Instruments



**2282**  
Plaster Shear  
210 mm



**2283**  
Crown Removing Plier  
14 cm



**2284**  
MONTFORT  
18 CM



**2285**  
BOHM  
16 cm



**2286**  
Telescope Crown  
Plier, Diamond coated  
13.0 cm



**2287**  
Telescope Crown  
Plier, Diamond coated  
13.0 cm



**2288**  
Telescope Crown Plier  
13.0 cm gerieften Maul  
15.0 cm gerieften Maul  
13.0 cm gelatts Maul  
15.0 cm gelatts Maul



**2289**  
Telescope Crown  
Plier, Fine  
15.0 cm





# Implants Instruments



**2290**  
1P  
150 mm



**2291**  
Fig. 1  
155 mm

Ø 2 mm



1P  
150 mm

Ø 3 mm



1T  
150 mm

Ø 1.60 mm



1  
155 mm



4  
155 mm

Ø 2.7 mm

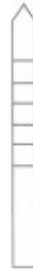

2P  
150 mm

Ø 4 mm



2T  
150 mm

Ø 1.90 mm



2  
155 mm



5  
155 mm

Ø 3.25 mm

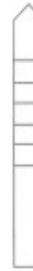

3P  
150 mm

Ø 5 mm



3T  
150 mm

Ø 2.80 mm



3  
155 mm



6  
155 mm

Ø 3.8 mm

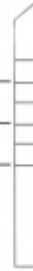

4P  
150 mm

10 mm  
14 mm  
18 mm

8 mm  
12 mm  
16 mm



# Implants Instruments



**2292**  
Fig. 1B  
165 mm

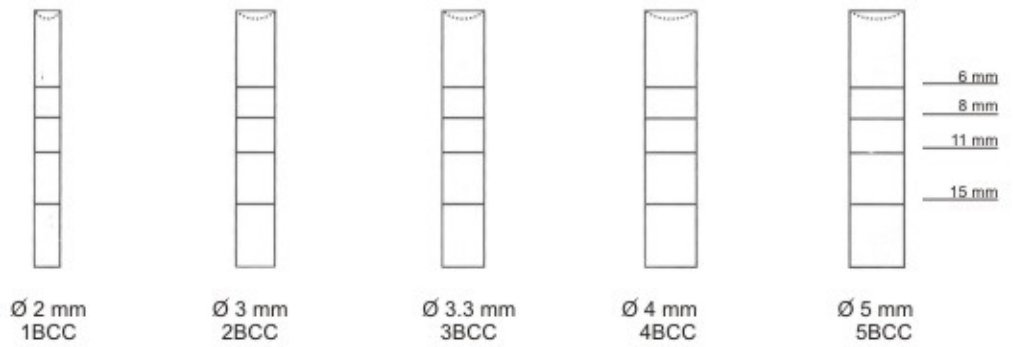
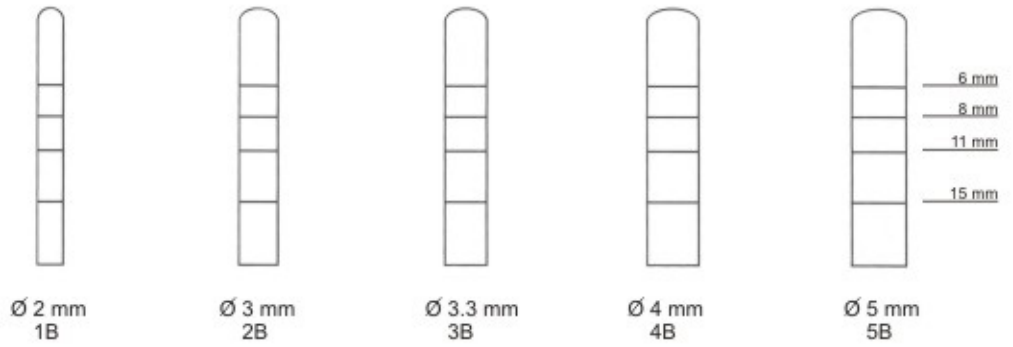

**2293**  
Fig. 1  
155 mm

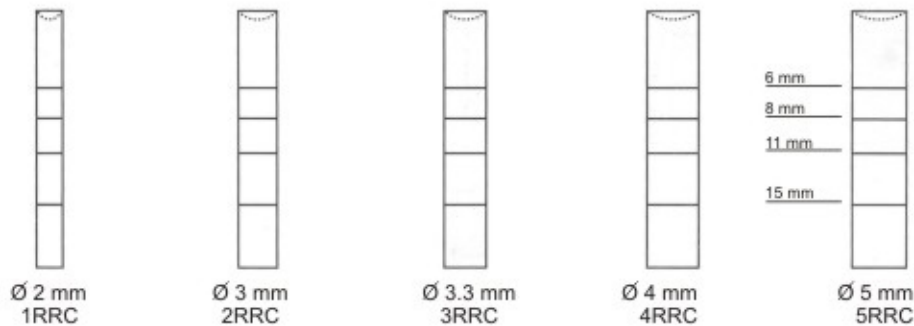
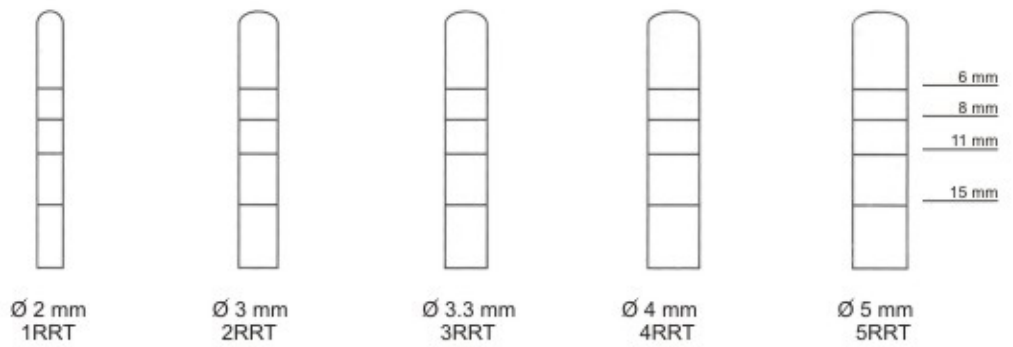



# Implants Instruments

## Endo guns for retrograds.

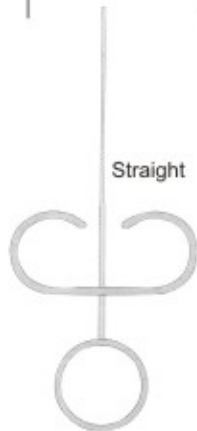

**2294**  
Ø 1.2 mm  
130 mm



Carry any mixed materials to perforations, apical or difficulty to access sites.



**2295**  
Ø 1.8 mm  
130 mm



## Bone Injectors



**2296**  
Ø 2.5 mm  
150 mm



**2297**  
Ø 4.4 mm  
150 mm



**2298**  
Ø 7 mm  
150 mm



**2299**  
Ø 2.5 mm  
150 mm



**2300**  
Ø 4.4 mm  
150 mm



Bone well

**2301**  
Ø 35 mm  
h 35 mm



**2302**  
Grinders for autogenous



**2303**  
Bone Mill Forcep  
17.0 cm





## Extracting Forceps “English Pattern”



**1079**  
Fig. 76S  
upper roots



**1080**  
Fig. 79  
lower third molars



**1081**  
Fig. 79A  
lower third molars



**1082**  
Fig. 81  
lower premolars  
and roots



# Suction Tubes, Bone Pluggers & Rongeurs



## Suction Tubes

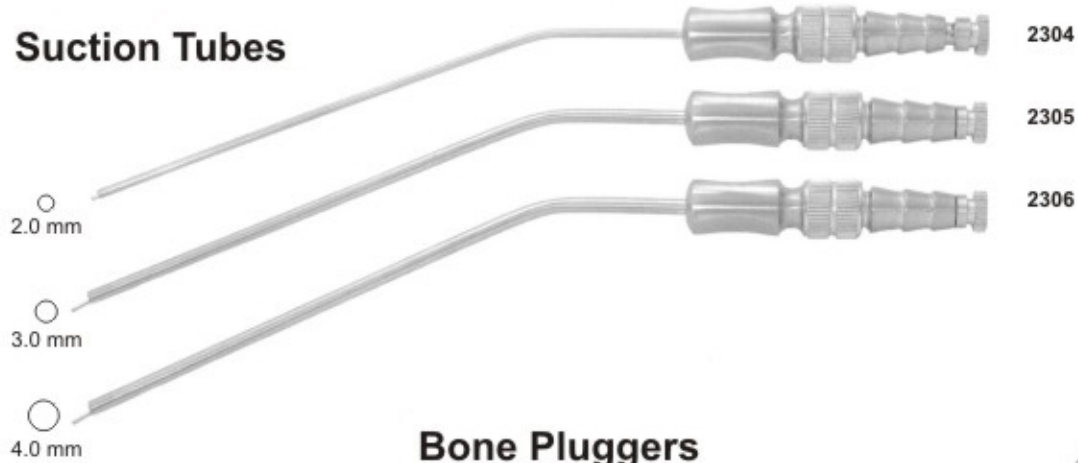

## Bone Pluggers



## Kerrison Rongeurs



- ( 1.5 mm inside ) 2311
  - ( 2.0 mm inside ) 2312
  - ( 3.0 mm inside ) 2313
  - ( 4.0 mm inside ) 2314
  - ( 4.5 mm inside ) 2315
- 16.5 cm**

- ( 1.0 mm inside ) 2316
  - ( 2.0 mm inside ) 2317
  - ( 2.50 mm inside ) 2318
- 16.5 cm**



# Implants Instruments

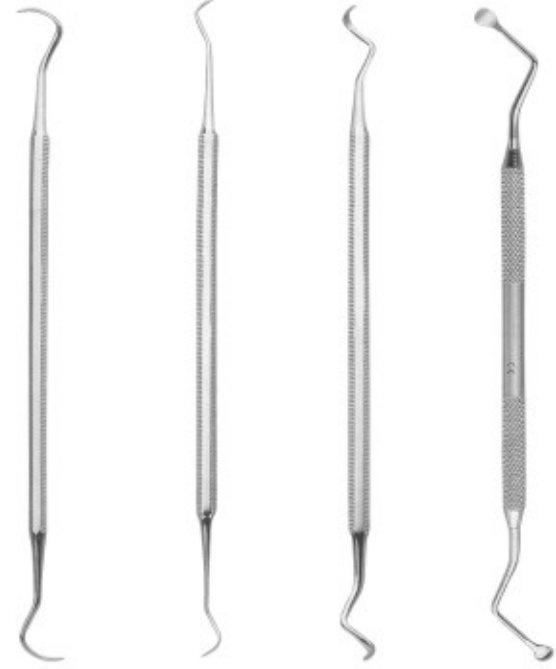

**2319**  
Fig. 1  
170 mm

**2320**  
Fig. 2  
175 mm

**2321**  
Fig. 3  
170 mm

**2322**  
LUCAS  
Fig. 88  
170 mm

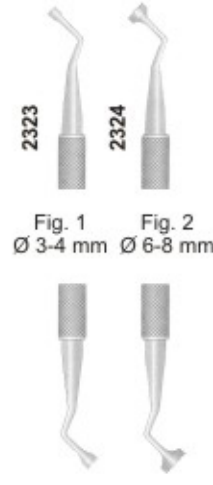

**2323**  
Fig. 1  
Ø 3-4 mm

**2324**  
Fig. 2  
Ø 6-8 mm

**Bone Compactors.**

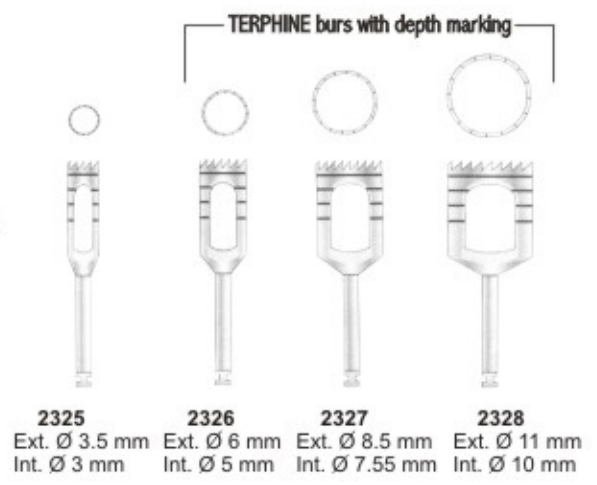

**TERPINE burs with depth marking**

**2325**  
Ext. Ø 3.5 mm  
Int. Ø 3 mm

**2326**  
Ext. Ø 6 mm  
Int. Ø 5 mm

**2327**  
Ext. Ø 8.5 mm  
Int. Ø 7.55 mm

**2328**  
Ext. Ø 11 mm  
Int. Ø 10 mm

## Sinus lift instruments



**2329**  
Fig.1

**2330**  
Fig.2

**2331**  
Fig.3

**2332**  
Fig.4

**2333**  
Fig.5

**2334**  
Fig.6

**2335**  
Fig.7

**2336**  
Fig.8

**2337**  
Fig.9





# Suction Tubes



		Canula, Curved 2338
2.0 mm		Canula, Curved 2339
3.0 mm		Canula, Curved 2340
4.0 mm		Canula, Curved 2341
		Canula, straight 2342
		Canula, Curved 2343
		Canula, Curved 2344
2.0 mm		Canula, Curved 2345
3.0 mm		Canula, Curved 2346
4.0 mm		Canula, Curved 2347 3.0 mm A 4.0 mm B 5.0 mm C



# Measuring Instruments



**2348**  
BOLEY Gauge



**2349**  
ZURICHER  
130 mm



**2350**  
VERNIER  
12 cm



**2351**  
VERNIER



**2352**  
VERNIER Gauge



**2353**  
VERNIER Gauge



**2355**  
Finger Ruler



**2354**  
LWANSON  
Crown Gauge



**2356**  
LWANSON  
Crown Gauge



**2357**  
Sliding Gauge  
10 cm



**2358**  
Spring Bow Divider  
6" Radius



**2359**  
ELECTRONIC  
DIGITAL CALIPERS  
VERNIER  
Gauge



**2360**  
ALBEE



**2361**  
Height Gauge  
Wick Type  
4.5mm  
4.0mm  
5.0mm  
3.5mm



# Bone Gauge & Measuring Instruments



**2362**  
Bone Gauge



**2363**  
Bone Caliper  
15 cm



**2364**  
Castroviejo



**2365 B**  
Straight



**2365 A**  
Castroviejo  
Curved



**2366 C**  
Castroviejo  
Straight

**2366 D**  
Curved



**2367**  
Gauge

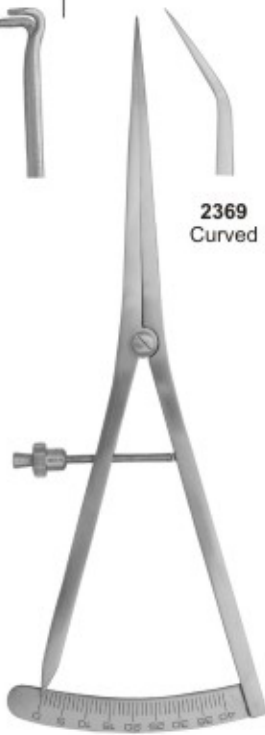

**2368**  
Castroviejo  
Straight



**2369**  
Curved



**2370**  
Castroviejo  
Straight



**2371**  
Curved



**2373**  
Boone - Gauge



**2372**  
Castroviejo



**2374** **2375**  
Curved Straight



**2376**  
Bracket Gauge. Ant/Post







# Amalgam Guns & Carriers



**2377**  
Medium-Large  
20 cm



**2378**  
Medium-Jumbo  
20 cm



**2379**  
Large-Jumbo  
20 cm



**2380**  
Jumbo-Jumbo  
20 cm



**2381**  
Regular-Jumbo  
Silicon Grip  
20 cm

Ø2 mm



**2382**  
Medium  
15.5 cm

Ø2.5 mm



**2383**  
Large  
15.5 cm

Ø3 mm



**2384**  
Jumbo  
15.5 cm



**2385**  
145 mm



**2386**  
130 mm



Ø2 mm



Ø2 mm  
**2387**  
Straight  
15 cm



Ø mm  
**2388**  
15 cm



**2389**  
15 cm  
90°



**2390**  
Amalgam Well  
Non Skid Base  
Ø3.5 mm



## Retainers, Bands, Strip Holder Clips, Napkin Holder

### Retainers



**2391**  
No. 1

**2392**  
No. 8

**2393**  
No. 9

### "Tofflemire" Type Retainers



**2394**  
JUNIOR-CA

**2395**  
SENIOR-CA

**2396**  
UNIVERSAL

### Tofflemire Bands

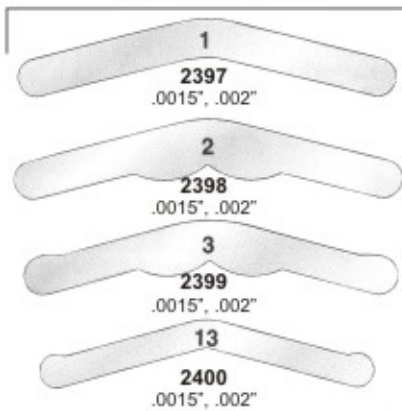

**2401**  
X-Ray Holder  
Small



Set of 10  
**2402**  
Film Hanger

### Napkin Holders



**2403**  
BALL CHAIN

**2404**  
NON-CHILL  
Clear Plastic

### Strip Holders

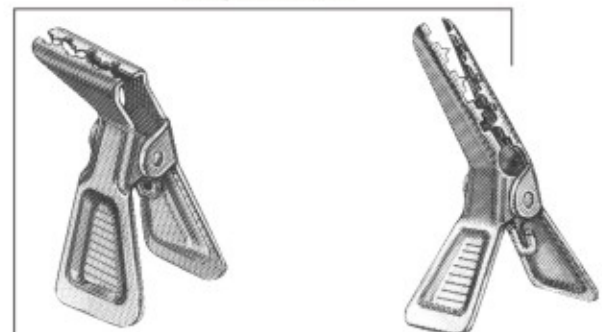

**2408**  
Strip Holder Clip  
90°

**2409**  
Strip Holder Clip  
45°

**2405**  
Finger Protector  
Small

**2406**  
Medium

**2407**  
Large



## Rubber Dam Instruments



**2410**  
IRORY  
Light weight, 170 mm



**2411**  
BREWER  
175 mm



**2412**  
BREWER  
175 mm



**2413**  
WHITE  
175 mm



**2414**  
IVORY  
170 mm



**2415**  
AINSWORTH  
Rubber Dam Punch  
170 mm



**2416**  
AINSWORTH  
Rubber Dam Punch  
170 mm



**2417**  
AINSWORTH  
Rubber Dam Punch  
170 mm

### Articulating Paper Forceps



**2421**  
MILLER  
Articulating  
Forceps  
15 cm



**2422**  
MILLER  
Articulating  
Forceps  
15 cm



**2418**  
"IV" Type  
Rubber Dam Punch  
160 mm



**2419**  
Plastic Rubber Dam  
Frame 242

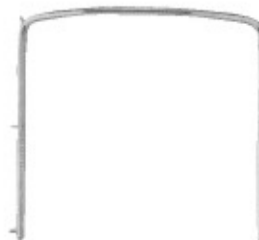

**2420**  
Rubber Dam Holder  
Stainless Steel Pins





# Rubber Dam Clamps



## LOWER MOLARS



2423  
76D-W3



2424  
76D-3



2429  
76D-7A



2430  
76D-7

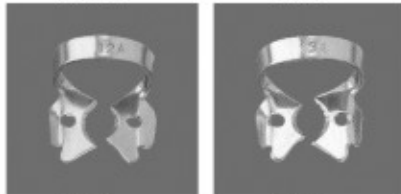

2435  
76D-12A



2436  
76D-13A

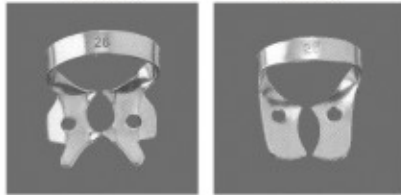

2441  
76D-26



2442  
76D-28



2445  
76D-W8A



2446  
76D-8A

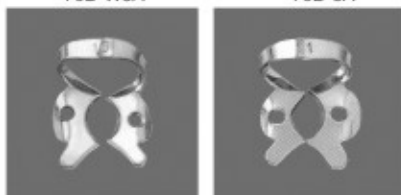

2447  
76D-10



2448  
76D-11



2451  
76D-24



2452  
76D-25

## UPPER MOLARS



2425  
76D-4



2426  
76D-5



2431  
76D-8



2432  
76D-26N



2437  
76D-30



2438  
76D-31



2443  
76D-201



2444  
205

## MOLARS



2449  
76D-14



2450  
76D-118



2453  
76D-27



2454  
76D-56



2455  
76D-14A

## PREMOLARS

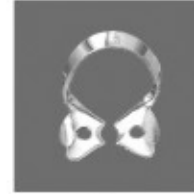

2427  
76D-0



2428  
76D-1



2433  
76D-2A



2434  
76D-2



2439  
76D-27N



2440  
76D-29

## ANTERIOR



2456  
76D-00



2457  
76D-1A



2458  
76D-9



2459  
76D-212



# Aspirating Syringes

4969/CO



4969/F



4969/CV



**2460**  
ml 1,8  
EU



**2461**  
ml 1,8  
EU/AM



**2462**  
ml 1,8  
EU/AM



**2463**  
Fig. 1  
ml 1,8  
EU



**2464**  
Fig. 1  
ml 1,8  
EU



**2465**  
SS INOX  
All inox & autoclavable  
black plastic handle  
passive automatic  
aspiration.



**2466**  
Fig. 1  
ml 1,8  
EU/Am



**2467**  
Fig. 1  
ml 1,8  
EU/Am



**2468**  
Fig. 1  
ml 1,8  
EU/Am



**2469**  
ml 1,2  
EU/Am



## Extracting Forceps "English Pattern"



**1083**  
Fig. 86A  
lower molars



**1084**  
Fig. 86B  
lower molars



**1085**  
Fig. 86C  
lower molars



**1086**  
Fig. 87  
lower molars



**1087**  
Fig. 91  
for separating  
lower molars



**1088**  
Fig. 99  
lower molars





# Syringes

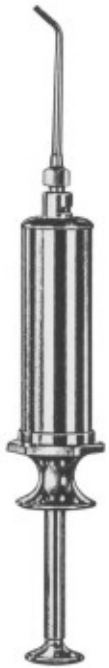

**2470**  
Water Syringe  
complete with  
1 cannula (Lure-Lock)



**2471**  
Water Syringe  
complete with  
1 cannula (Lure-Lock)



**2472**  
Metal Water Syringe  
self-filling, with 1  
cannula (Lure-Lock)



**2473**  
Sparrel Barrel with  
plunger suitable for  
syringes



**2474**  
Cannula, only, with  
Luer-Lock connector  
suitable for syringes



**2475**  
Articulating  
Barrel Syringe



**2476**  
ml 1,8



**2477**  
ml 1,8



**2478**



**2479**



**2480**



**2481**  
Fig. 1  
ml 1,8 EU



**2485**  
Fig. 1  
ml 1,8 EU



**2482**  
Water  
point



**2483**  
Water  
point



**2484**  
Water  
point



# Dental Tweezers



**2486**  
ADSON  
Curved 14 cm



**2487**  
ADSON  
1X2 / 12 cm



**2488**  
ADSON  
12 cm



**2489**  
MICRO ADSON  
15 cm



**2490**  
STANDARD  
14,18,25 cm



**2491**  
CUSHING  
18 cm



**2492**  
Curved



**2493**  
SELECT  
15,18,20 cm



**2494**



**2495**  
MCINDOE  
15 cm



**2496**  
GILLIES  
15 cm

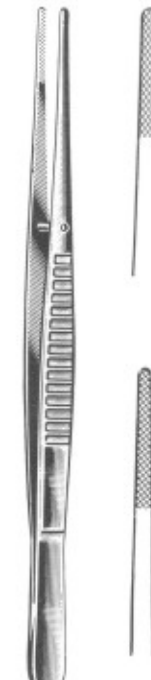

**2497**  
WAUGH  
15,20 cm

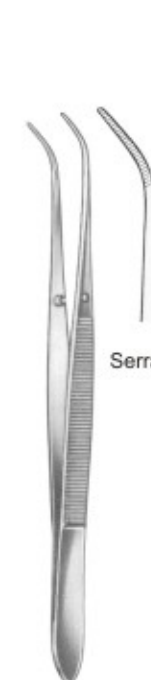

Serrated

**2498**  
PERRY  
13 cm



**2499**  
KOPP  
15.5 cm



## Dental Tweezers



**2500**  
COLLEGE  
15 cm



smooth



**2501**  
COLLEGE  
15 cm



serrated



**2502**  
COLLEGE  
15 cm



smooth



**2503**  
COLLEGE  
15 cm



serrated



**2504**  
COLLEGE  
15 cm



smooth



**2505**  
COLLEGE  
15 cm



serrated



**2506**  
COLLEGE  
15 cm



smooth



**2507**  
COLLEGE  
15 cm



serrated





## Dental Tweezers



**2508**  
MERIAM  
16 cm



smooth



**2509**  
MERIAM  
16 cm



serrated



**2510**  
MERIAM  
16 cm



smooth



**2511**  
MERIAM  
16 cm1



serrated



**2512**  
MERIAM  
16 cm



smooth



**2513**  
MERIAM  
16 cm



serrated



**2514**  
MERIAM  
16 cm



smooth



**2515**  
MERIAM  
16 cm



serrated



# Dental Tweezers



**2516**  
COLLEGE  
14.5 cm, 5<sup>3</sup>/<sub>4</sub>"



serrated



**2517**  
FLAGG  
16 cm, 6<sup>1</sup>/<sub>4</sub>"



serrated



**2518**  
FLAGG  
16 cm, 6<sup>1</sup>/<sub>4</sub>"



smooth



**2519**  
LANDGRAF  
15 cm, 6"



serrated



smooth



**2520**  
15,5 cm, 6<sup>1</sup>/<sub>8</sub>"



smooth



**2521**  
15.5 cm, 6<sup>1</sup>/<sub>8</sub>"



con cierre



**2522**  
LONDON-COLLEGE  
15 cm, 6"



serrated



**2523**  
LONDON-COLLEGE  
15 cm, 6"



smooth



**2524**  
LONDON-COLLEGE  
15 cm, 6"



serrated



**2525**  
LONDON-COLLEGE  
15 cm, 6"



smooth



# Dental Tweezers



**2526**  
LONDON-COLLEGE  
15 cm, 6"



**2527**  
LONDON-COLLEGE  
15 cm, 6"



con cierre



**2528**  
MERIAM  
16 cm, 6 1/4"



serrated



smooth

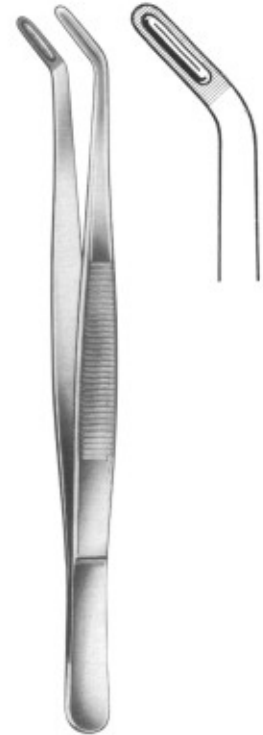

**2529**  
ALLEN  
18 cm, 7 1/8"



**2530**  
ALBRECHT  
16 cm, 6 1/4"



**2531**  
ALBRECHT  
16 cm, 6 1/4"



**2532**  
16 cm, 6 1/4"



**2533**  
16 cm, 6 1/4"



**2534**  
16 cm, 6 1/4"





## Sterilizing & Lab Instruments

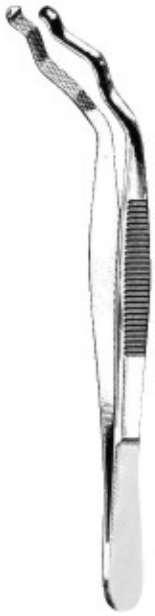

**2535**  
DAVIS  
6"



**2536**  
Grasping Forceps  
6 1/4"



**2537**  
Mesh Bur & Diamond Holder  
Large, 2 1/8" Diameter



**2538**  
Soldering Tweezers  
6 1/4"



**2539**  
Narrow Fine  
4 3/4"



**2540**  
Super Fine  
4 3/8"



**2541**  
Fine Curved  
4 1/2"



**2542**  
Bonding Bracket  
Holder  
136 mm



**2543**  
Bonding Bracket  
Holder  
135 mm



**2544**  
Bonding Bracket  
Holder  
135 mm



**2545**  
Bonding Bracket  
Holder  
140 mm



# Endodontic Forceps



**2546**  
Endo Forceps  
4 3/4"



**2547**  
PEETS Forceps  
4 3/4", Useful For  
Removing Broken  
Instruments

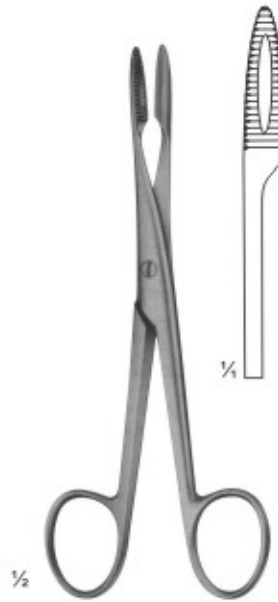

**2548**  
Without Ratchet  
145 mm

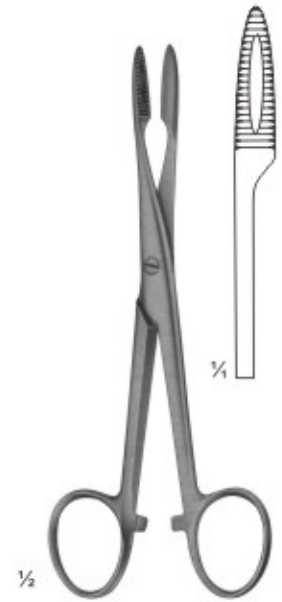

**2549**  
With Ratchet  
145 mm



**2550**  
CRILE  
140 mm

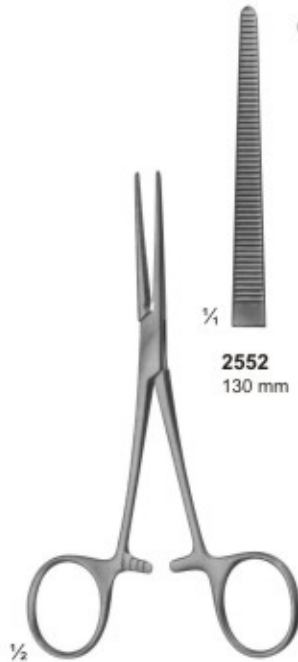

**2551**  
PEAN  
Slender type

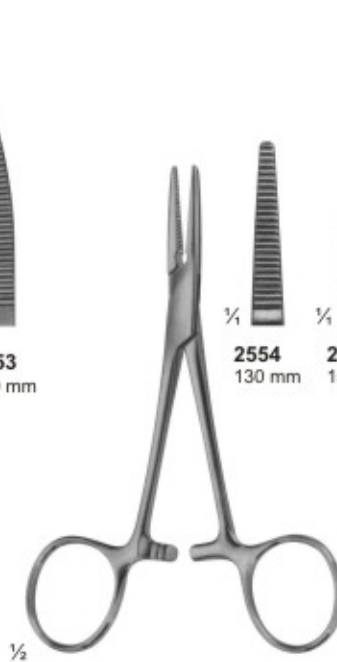

**2554**  
SPENCER-WELLS



**2552**  
130 mm



**2553**  
140 mm



**2554**  
130 mm



**2555**  
150 mm



**2556**  
130 mm



**2557**  
150 mm



# Tissue Forceps



**2558**  
BABY-ALLIS  
5", Straight  
4x5 teeth extra delicate



**2559**  
ALLIS  
6", Straight  
4x5 teeth extra delicate



**2560**  
ALLIS  
6", Straight  
4x5 teeth extra delicate



**2561**  
1x2 teeth  
6"



**2562**  
SEMKIN  
6", Straight,  
1x2 teeth



**2563**  
ADSON  
4 3/4"  
1x2 teeth



**2564**  
BROWN-ADSON  
4 3/4"  
7x7 teeth



**2565**  
BROWN  
6"  
8x8 teeth



**2566**  
RUSSIAN  
6"  
8x8 teeth



**2567**  
Extra-Delicate,  
Straight, 4"  
1x2 teeth





## Hemostatic Forceps, Towel Clamps, Napkin Hold



**2568**  
HALSTED-MOSQUITO  
Straight, Curved, 5"



**2569**  
HALSTED-MOSQUITO  
Straight, Curved, 5"  
1x2 teeth



**2570**  
HALSTED-MOSQUITO  
Jaws 45 Angled on Flat, 5"  
Extra Delicate



**2571**  
KELLY  
5 1/2", Straight



**2572**  
JONES  
3 1/2"



**2573**  
BACKHAUS  
3 1/2"



**2574**  
BACKHAUS  
5 1/4"



**2575**  
LORNA  
Non Perforated  
3 1/2"



## Extracting Forceps "English Pattern"



**1089**  
Fig. 101  
upper premolars  
and roots



**1090**  
Fig. 100  
upper roots



**1091**  
Fig. 99 1/4  
lower molars



**1092**  
Fig. 99 1/2  
lower molars



# Retractors, Depressors, Mouth Gags



**2576**  
DENHART



**2577**  
DENHARDT  
Mouth Gag With  
Silicon Inserts,  
Interchangeable  
Size: 125 mm

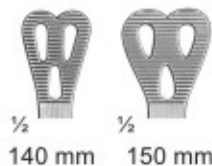

**2578**  
WIEDER  
Tongue depressor  
**2579** 140mm  
**2580** 150mm



**2583**  
WEITLANER  
Sharp  
130 mm

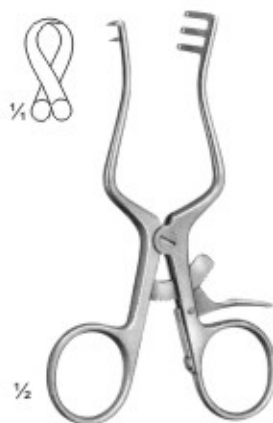

**2584**  
WEITLANER  
Sharp  
110 mm

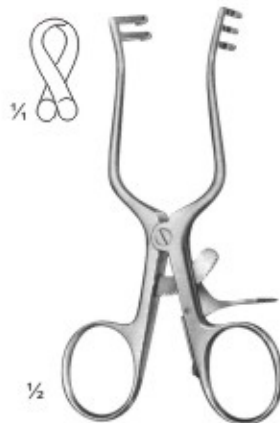

**2585**  
WEITLANER  
Semi-Sharp  
110 mm



**2581**  
TOBOLD  
Tongue depressor  
Size: 145 mm



**2582**  
ANDREW  
Tongue depressor  
Size: 110 mm



**2586**  
MOLT  
Pediatric



**2587**  
MOLT  
Child



**2588**  
MOLT  
Adult



**2589**  
FERGUSSON-ACKLAND  
Mouth Gag  
Size: 145 mm



**2590**  
ROSER KOENIG  
Mouth Gag  
Size: 160mm / 185mm





# Lip & Cheek Retractors



**2591**  
140 mm



**2592**  
BRUENINGS  
190 mm



**2593**



**2594**



**2595**



**2596**



**2597**



**2598**



**2599**  
Mouth Gag with  
Tongue Depressor  
11.0 cm  
13.0 cm  
15.0 cm



**2600**  
Mouth Gag without  
Tongue Depressor  
11.0 cm  
13.0 cm  
15.0 cm



**2601**  
Jennings, Mouth Gag  
11.0 cm  
13.0 cm  
15.0 cm



**2602**



**2603**



# Lip & Cheek Retractor

- 30 x 4 mm A
- 23 x 7 mm B
- 24 x 11 mm C
- 29 x 10 mm D
- 30 x 11 mm E
- 32 x 14 mm F
- 40 x 11 mm G
- 42 x 10 mm H
- 50 x 11 mm I
- 55 x 11 mm J
- 60 x 11 mm K
- 70 x 11 mm L
- 70 x 14 mm M



**2604**  
LANGENBECK  
210 mm



**2605**  
KOCHER-LANGENBECK  
215 mm



**2606**  
BUCHS  
205 mm



38 x 18 mm

**2607**  
KOCHER  
230 mm



**2608**  
MIDDELDORPF



**2609**  
15 x 15 mm  
220 mm



**2610**  
20 x 22 mm  
215 mm



**2611**  
28 x 28 mm  
235 mm



**2612**  
KOCHER  
230 mm



**2613**  
COLLIN  
150 mm



**2614**  
ROUX  
Set  
165 mm



## Sterilizing Forceps



**2615**  
Sterilizing Forcep Curved  
20 cm A  
25 cm B  
30 cm C



**2616**  
Sterilizing Forcep Straight  
20 cm A  
25 cm B  
30 cm C



**2617**  
Sterilizing Forcep  
30 cm



**2618**  
Becht Tweezer



**2619**  
Sterilizing Forcep  
23 cm A  
30 cm B



**2620**  
Sterilizing Forcep  
20 cm







# Tissue Retractors & Hooks



**2621**  
3 sharp prongs



**2622**  
2 sharp prongs  
6"



**2623**  
2 sharp prongs  
6"



**2624**  
FOMON  
145 mm



**2625**  
ALM  
70 mm



**2626**  
SENN  
3 sharp prongs  
6 3/8"



**2627**  
TOENNIS  
Dura Retractor  
150mm



**2628**  
JOSEPH  
165 mm



**2629**  
GILLIES  
180 mm



## Orthodontic Pliers



**2630**  
Light Wire Cutter



**2631**  
Wire Cutter



**2632**  
Posterior Band Remover  
Long



**2633**  
Posterior Band Remover  
Short

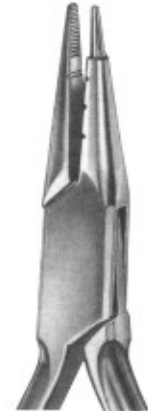

**2634**  
Jarabak Plier  
Short



**2635**  
Distal End Cutter  
Safety End Cutter



**2636**  
Distal End Cutter



**2637**  
Kim's Plier



**2638**  
Loop Forming Plier



**2639**  
Tweed Arch Bending Plier



**2640**  
Utility Plier



**2641**  
Bonding Bracket Remover



**2642**  
Lingual Arch Plier



**2643**  
Light Wire Plier



**2644**  
Wire Cutter  
12.5 cm



## Orthodontic Pliers



**2645**  
Fig. 101  
Wire Bending



**2646**  
Fig. 118  
PEESO  
Collar

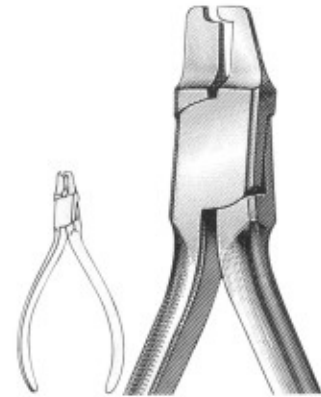

**2647**  
Fig. 417  
Crown Shell

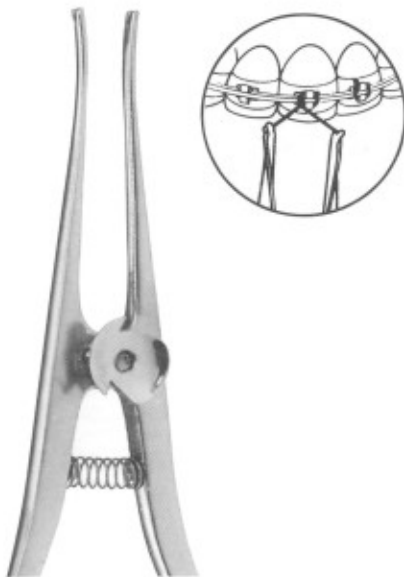

**2648**  
STEINER  
150 mm  
Ligature Pliers

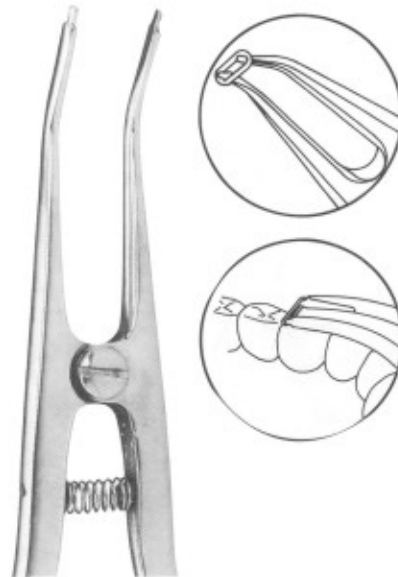

**2649**  
Separating Pliers Elastics  
150 mm



**2650**  
121-Lab & Office





## Orthodontic Pliers



**2651**  
How Plier-Titanium Alloy  
With special coated beaks

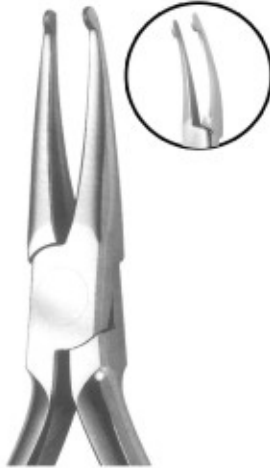

**2652**  
How Plier  
Tips are 1/8"(3.2mm)  
diameter



**2653**  
How Plier  
Tips are 1/8"(3.2mm)  
diameter



**2654**  
How Plier-Small  
Tips are 3/32"(2.4mm)  
diameter

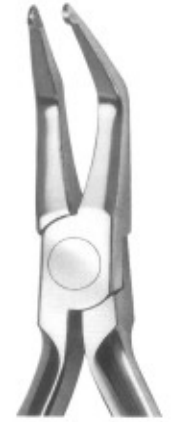

**2655**  
How Plier-Offset  
Tips are 1/8"(3.2mm)  
diameter



**2656**  
Weingart Utility Plier  
-Titanium Alloy  
with special coated beaks

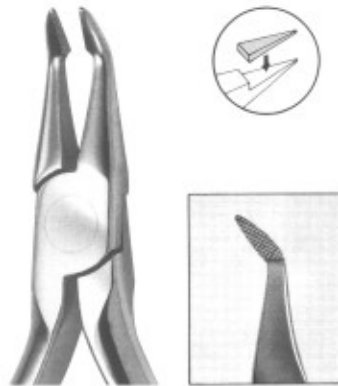

**2657**  
Weingart Utility Plier  
New type of the Weingart Utility Plier  
designed for a more precise operation.

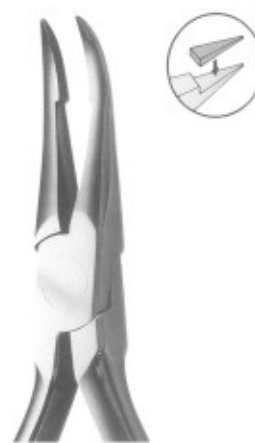

**2658**  
Weingart Utility Plier

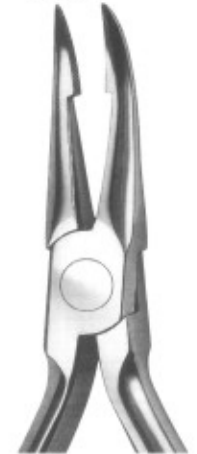

**2659**  
Weingart Utility Plier

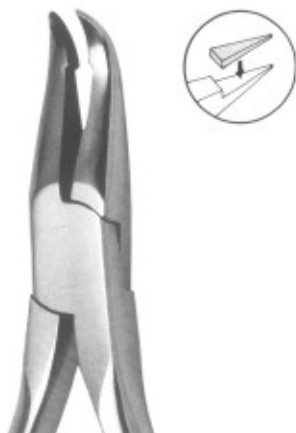

**2660**  
Weingart Utility Plier

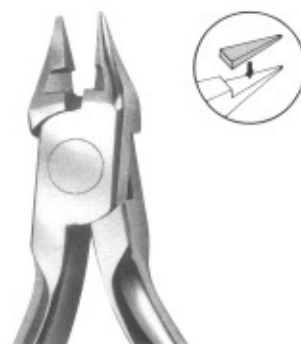

**2661**  
Bird Beak Plier With Cutter  
**Maximum Bending &  
Cutting Capacity:**  
Wires up to .032"



**2662**  
Bird Beak Plier  
**Maximum Bending Capacity:**  
Wires up to .032"



**2663**  
Bird Beak Plier  
**Maximum Bending  
Capacity:**  
Wires up to .030"



# Orthodontic Pliers



**2664**  
TWEED (Fig. 98)  
13 cm, 5 1/8"  
Tweed Loop Omega Pliers.



**2665**  
TWEED - (Fig. 90)  
14 cm, 5 1/2"



**2666**  
O'BRIEN - (Fig. 97)  
14 cm, 5 1/2"

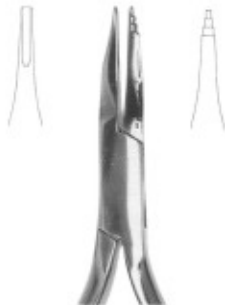

**2667**  
TWEED (Fig. 96)  
14 cm, 5 1/2"

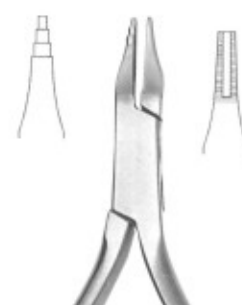

**2668**  
TWEED (Fig. 95)  
13.5 cm, 5 1/4"



**2669**  
SCHWARZ (Fig. 29)  
12.5 cm, 5"



**2670**  
NANCE (Fig. 80)  
13 cm, 5 1/8"

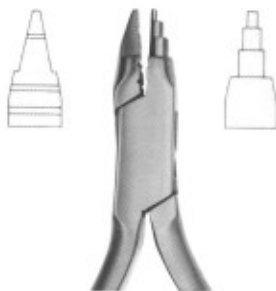

**2671**  
YOUNG (Fig. 55)  
13 cm, 5 1/8"



**2672**  
SCHWARZ (Fig. 30)  
13 cm, 5 1/8"



**2673**  
Optical Plier (Fig. 53)  
14 cm, 5 1/2"

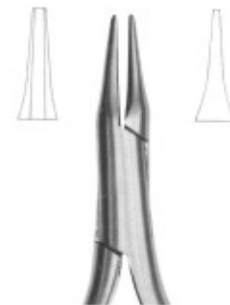

**2674**  
Schwarz (Fig. 79)  
13.5 cm, 5 1/4"



# Orthodontic Pliers



**2675**  
NANCE (Fig. 56)  
12.5 cm, 5"  
Wire bending Pliers



**2680**  
14.0 cm  
Goslee Contouring Plier



**2676**  
JOHNSON (Fig. 59)  
13.5 cm, 5 1/4"  
Contouring Plier.



**2677**  
REYNOLDS (Fig. 61)  
13 cm, 5 1/8"  
Contouring Plier.



**2678**  
De La Rosa (Fig. 34)  
12.5 cm, 5"  
Contouring Plier, Non-Grooved



**2679**  
De La Rosa (Fig. 35)  
12.5 cm, 5"  
Contouring Plier, Grooved



**2681**  
14.0 cm  
Goslee Contouring Plier

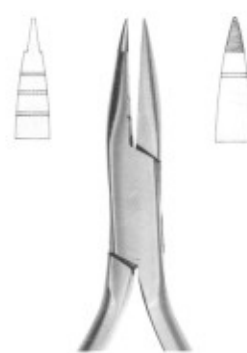

**2682**



**2683**  
Fig. 58  
12.5 cm, 5"  
Lingual Arch Bending Plier



**2684**  
Frevort/Tweed (Fig. 51)  
12.5 cm, 5"  
Tweed Arch Plier/Standard Jaw



**2685**

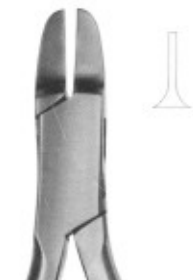

**2686**  
ANGLE (Fig. 52)  
13 cm, 5 1/8"  
Arch Forming Plier





## Extracting Forceps "English Pattern"



**1093**  
Fig. 102  
upper molars right



**1094**  
Fig. 103  
upper molars left



**1095**  
Fig. 105  
lower incisors



**1096**  
Fig. 106  
lower incisors



**1097**  
Fig. 103  
upper canines



## Orthodontic Pliers



**2687**  
Fig. 60  
13 cm, 5 1/8"  
Wire & Clasp Bending Pliers



**2688**  
Fig. 60  
13 cm, 5 1/8"  
Wire & Clasp Bending Pliers

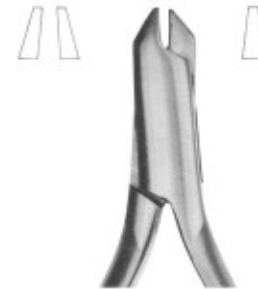

**2689**  
Aderer (Fig. 57)  
12 cm, 4 3/4"  
Wire & Clasp Bending Pliers



**2690**  
49 e 49 TC  
14 cm, 5 1/2"  
Band Removing Plier, short pad



**2691**  
50 e 50 TC  
14 cm, 5 1/2"  
Band Removing Plier, long pad



**2692**  
Fig. 84  
14.5 cm, 5 3/4"  
Band pinshing & ligature locking plier, serrated



**2693**  
Fig. 72  
14 cm, 5 1/2"  
Band pinshing & ligature locking plier, serrated



**2694**  
BRACKET (Fig. 82)  
13.5 cm, 5 1/4"  
Direct Bonding Bracket Remover



**2695**  
BRACKET (Fig. 83)  
13.5 cm, 5 1/4"  
Direct Bonding Bracket Remover



# Orthodontic Pliers



**2696**  
38c, 38TC  
13.5 cm, 5 1/4"  
Contouring closing loop pliers,  
wire bending, cutter.

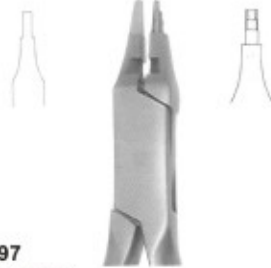

**2697**  
40c, 40TC  
13.5 cm, 5 1/4"  
Contouring pliers light wire pliers  
grooved with cutter.



**2698**  
Fig. 81  
12.5 cm, 5"  
Sling clasp & wire bending plier



**2699**  
Fig. 28  
14 cm, 5 1/2"  
Sling clasp & wire bending plier.



**2700**  
Fig. 21  
13 cm, 5 1/8"  
Light wires pliers, grooved



**2704**  
46c - 46 TC  
ADAMS - N. 139c  
12.5 cm, 5"  
Bird beak with cutter.



**2701**  
ADAMS, 23, 23TC  
12.5 cm, 5"  
Sling clasp & wire bending plier.



**2702**  
ADAMS (Fig. 33)  
12.5 cm, 5"  
For retaining elements.



**2703**  
ADAMS (Fig. 44)  
12.5 cm, 5"  
Sling clasp & wire bending plier.



**2705**  
Universal Wire Bending  
Pliers (ADAMS) 47 TC, N.64  
12.5 cm, 5"  
Sling clasp & wire bending plier.



**2706**  
86c, 86 TC  
Angle Bird Beak - N.138  
12.5 cm, 5"  
Sling clasp & wire bending plier.





## Orthodontic Cutters With T.C.



Ø 1.0 mm  
(0.40")

**2707**  
Fig. 18 TC  
15 cm, 6"



Ø 1.0 mm  
(0.40")

**2708**  
Fig. 92 TC  
14 cm, 5 1/8"



Ø 0.4 mm  
(0.16")

**2709**  
Fig. 91 TC  
13 cm, 5 1/8"



Ø 0.4 mm  
(0.16")

**2710**  
Fig. 99 TC  
13 cm, 5 1/8"



Ø 0.4 mm  
(0.16")

**2711**  
Fig. 94 TC  
13 cm, 5 1/8"  
Angled at 15° with or  
without spring on \  
the handles.



**2712**  
Fig. 85 TC  
13 cm, 5 1/8"



**2713**  
Fig. 87 TC  
13 cm, 5 1/8"



**2714**  
Fig. 85 TC  
Angled at 15  
13 cm, 5 1/8"



**2715**  
ADAMS 87 TC  
Angled at 15  
13 cm, 5 1/8"



## Orthodontic Distal & Cutters





# Pliers for Orthodontic & Prosthetics



**2721**  
UNIVERSAL  
150 mm



**2722**  
WALDSACHS  
155 mm



**2723**  
ADERER  
125 mm



**2724**  
NANCE  
125 mm



**2725**  
REYNOLDS  
125 mm



**2726**  
HOW  
145 mm



**2727**  
HOW  
140 mm



**2731**  
FURRER  
150 mm



**2728**  
WALDRON  
125 mm

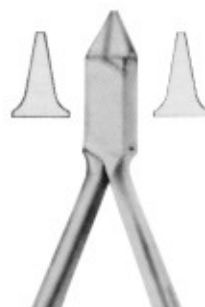

**2729**  
ADAMS  
125 mm



**2730**  
ANGLE  
125 mm

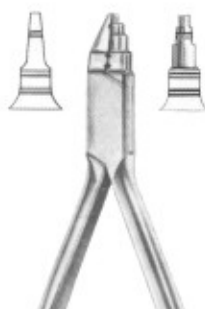

**2732**  
YOUNG  
130 mm



**2733**  
NANCE  
130 mm





## Pliers for Orthodontic & Prosthetics



**2734**  
LANGEBECK  
125 mm



**2735**  
LANGEBECK  
140 mm



**2736**  
LANGEBECK  
130 mm



**2737**  
PEESO  
125 mm



**2738**  
GOSLEE  
125 mm



**2739**  
FISCHER  
140 mm



**2740**  
FISCHER  
140 mm



**2741**  
JOHNSON  
130 mm

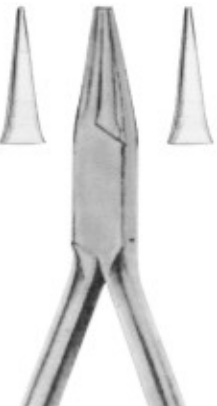

**2742**  
MSY  
130 mm



**2743**  
MC KELLOPS  
155 mm



**2744**  
ANDRESEN  
130 mm



**2745**  
SCHWARZ  
130 mm



## Rongeurs



**2746**  
BLUMENTHAL  
6", 30°, Standard

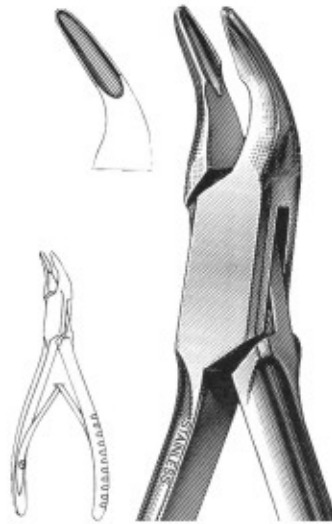

**2747**  
MINI-BLUMENTHAL  
6", 45°

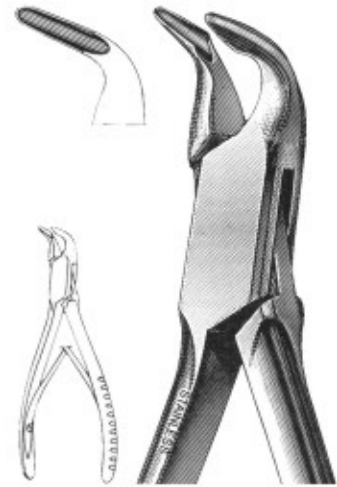

**2748**  
MINI-BLUMENTHAL  
6", 90°

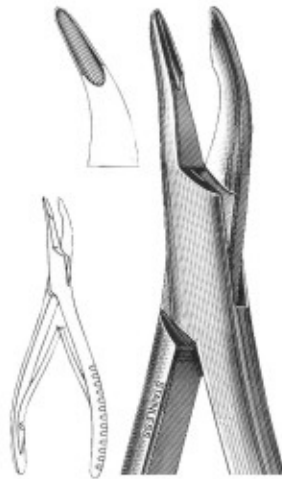

**2749**  
BLUMENTHAL  
7", 30°

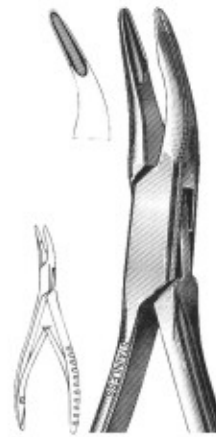

**2750**  
MINI-BLUMENTHAL  
4 1/2", 30°

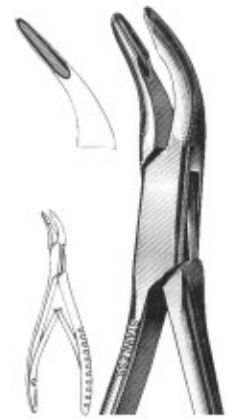

**2751**  
MINI-BLUMENTHAL  
4 1/2", 45°



# Rongeurs



**2752**  
CLEVELAND  
No. 5-Side Cutting,  
6 3/4"

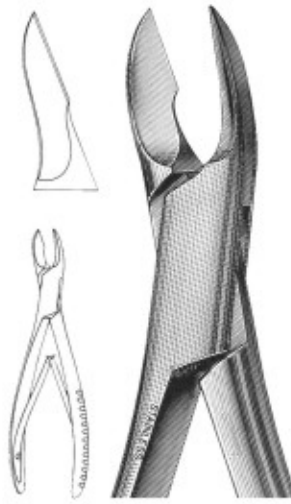

**2753**  
CLEVELAND  
No. 5A-Side Cutting,  
6 1/2"

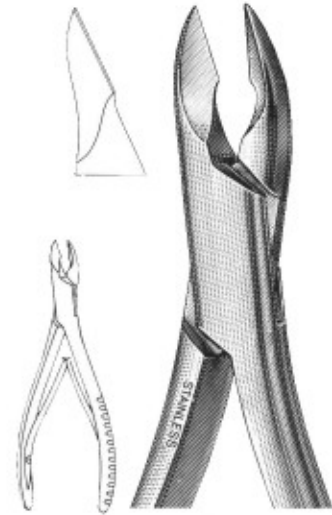

**2754**  
CLEVELAND  
No. 5S-Side Cutting,  
6"

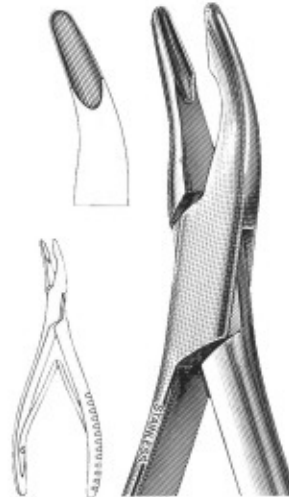

**2755**  
No. 1A-MEAD  
6 1/2"

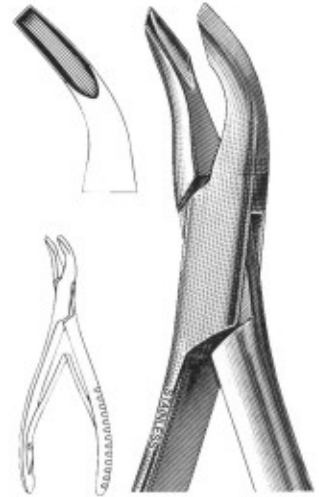

**2756**  
MEAD, Square  
No. 2A  
Tips, 6 1/2"

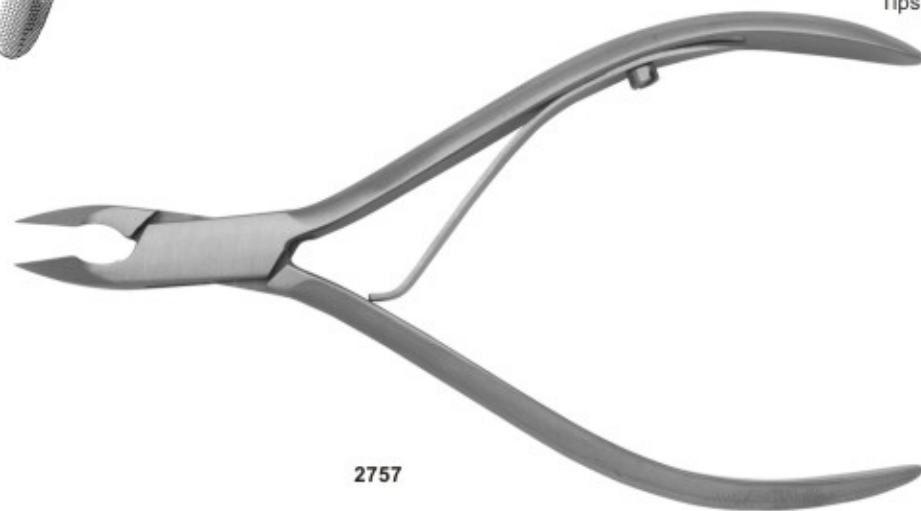

**2757**





# Rongeurs



**2757**  
FRIEDMAN  
5 1/2"

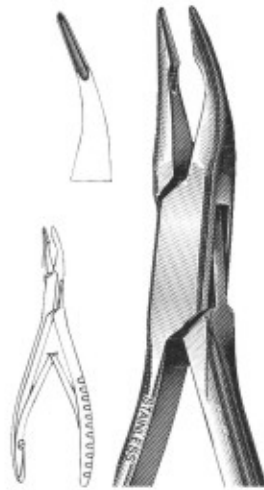

**2758**  
MICRO-FRIEDMAN  
5 1/2", 15° Curved Jaws

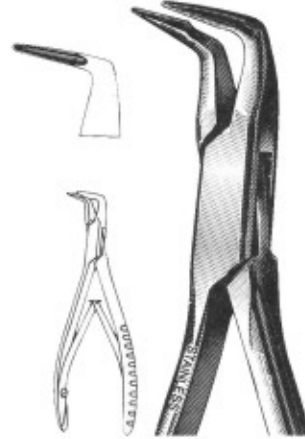

**2759**  
MICRO-FRIEDMAN  
Perio Rongeur, 5 1/2"

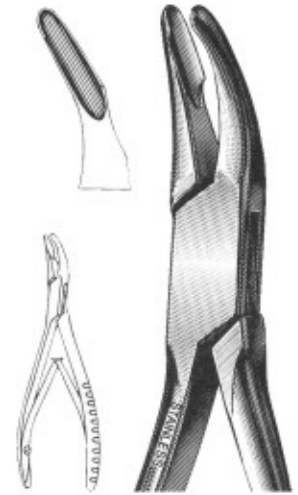

**2760**  
CLEVELAND  
No. 4 - 5 1/2"

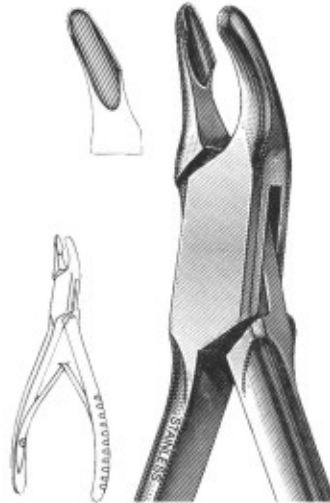

**2761**  
CLEVELAND  
No. 4A - 6 1/2"

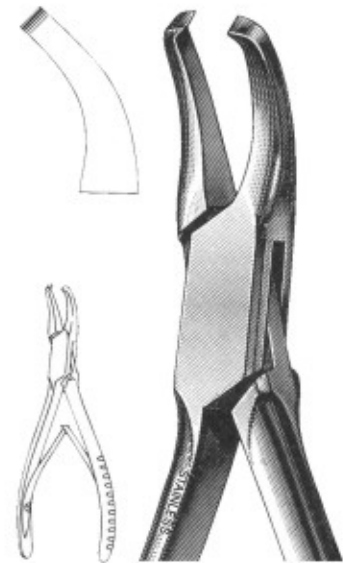

**2762**  
GARDNER  
No. 6A, End Cutting  
6 1/2"



## Rongeurs



**2763**  
BEYER  
Double Action,  
16,18 cm



**2764**  
No. 1  
6 1/2"

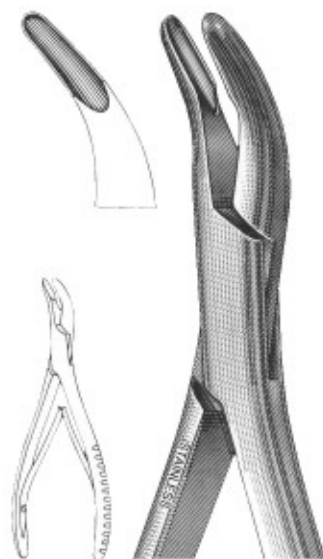

**2765**  
HARTMAN  
5 3/4"  
Strong Curve

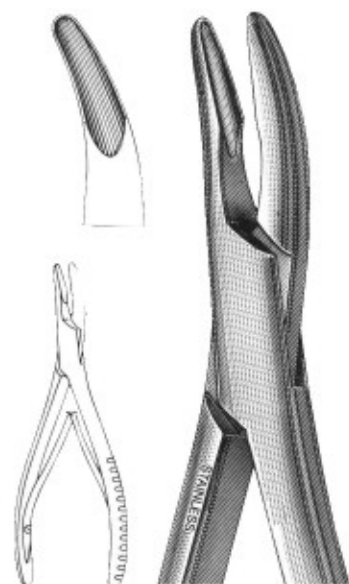

**2766**  
BANE  
Slight Curve  
7"



## Extracting Forceps "English Pattern"



**1098**  
Fig. 112  
upper roots

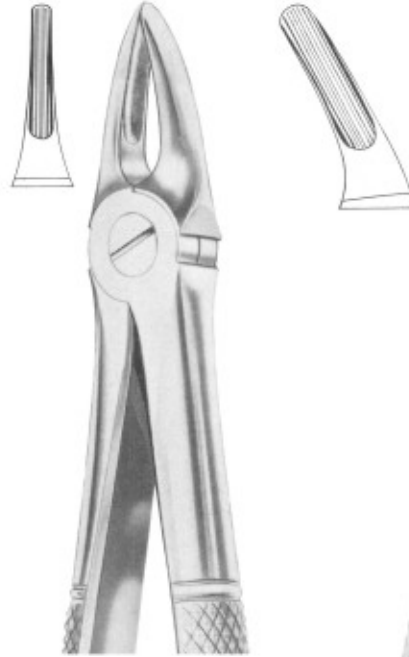

**1099**  
Fig. 113  
upper roots



**1101**  
Fig. 136  
upper premolars  
and roots



**1102**  
Fig. 137  
lower incisors  
and roots



**1100**  
Fig. 114  
upper roots



**1103**  
Fig. 143  
lower roots





## Needle Holders



**2767**  
COLLIER  
5", Fenestrated Jaws



**2768**  
DERF  
4 3/4"



**2769**  
WEBSTER  
Delicate Smooth Jaws  
5"



**2770**  
NEIVERT  
One Offset Ring  
5"



**2771**  
OLSEN-HEGAR  
5 1/2"



**2772**  
BAUMGARTNER  
5 1/2"



**2773**  
CRILE-WOOD  
6"



**2774**  
GARDNER  
5"



# Needle Holders



**2775**  
MAYO-HEGAR  
5"



**2776**  
CASTROVIEJO  
Smooth Jaws  
14 cm



**2777**  
CASTROVIEJO  
Smooth Jaws  
14 cm



**2778**  
CASTROVIEJO  
Smooth Jaws  
14 cm



**2779 A**  
18 cm



**2780 A**  
18 cm



**2781**  
BOYNTON  
5"



**2782**  
CRILE  
6"



**2783**  
MATHIEU  
5 1/2"



**2784**  
STEVENS  
6 1/2"



# Micro Surgery Set



**2785**  
Micro Scissor  
Straight, 155 mm



**2786**  
Micro Scissor  
Straight, 150 mm



**2787**  
Micro Scissor  
Curved, 150 mm



**2788**  
Micro Scissor  
Curved, 155 mm



**2789**  
CASTROVIEJO  
T.C.  
Straight, 180 mm



**2790**  
Retractor  
Fig.3  
165 mm



**2791**  
Micro Adson  
120 mm



**2792**  
GERALD  
Curved,  
180 mm



**2793**  
GERALD  
Straight,  
175 mm



**2794**  
Micro Adson  
160 mm



**2795**  
Micro Surgery Set 10 Pieces.





# Scissors

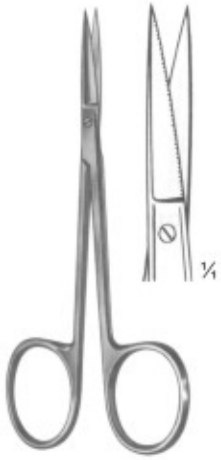

**2796**  
IRIS (Standard)  
Straight  
11.5 cm, 4 1/2"

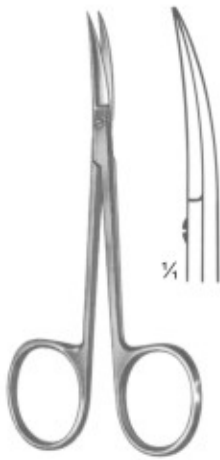

**2797**  
IRIS (Standard)  
Curved  
11.5 cm, 4 1/2"



**2798**  
STEVENS  
Dissecting Scissors  
Size: 115 mm

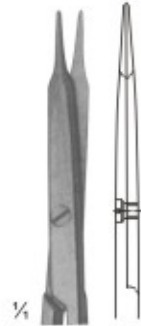

**2799**  
Sharp



**2800**  
Sharp



**2801**  
Blunt



**2802**  
Blunt



**2803**



**2804**  
JOSEPH  
Size: 150 mm

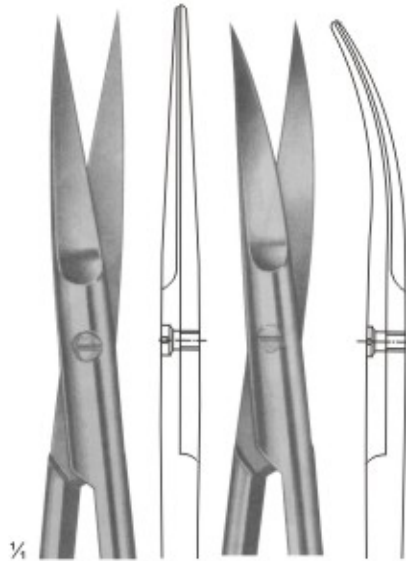

**2805**

**2806**

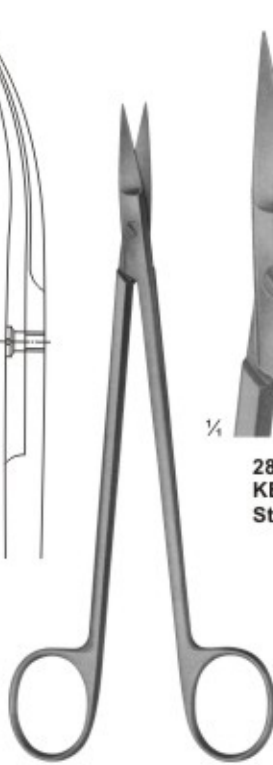

**2808**  
KELLY  
Straight

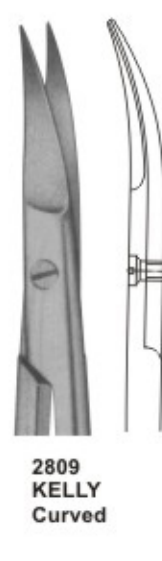

**2809**  
KELLY  
Curved

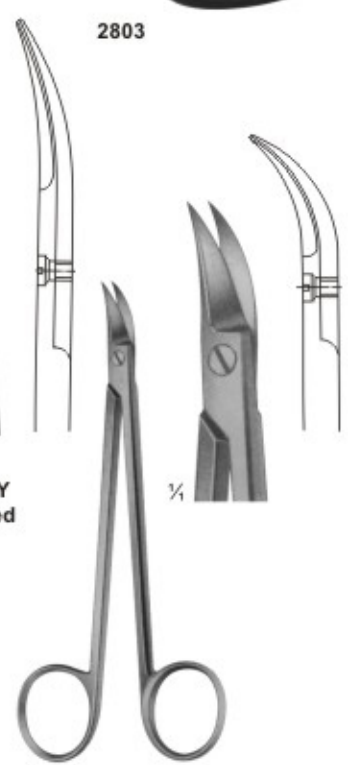

**2810**  
QUINBY  
Size: 130 mm



# Scissors



**2811**  
Standard - Types  
Size: 115 mm



**2812**  
DEEVER  
With flat lock



**2813**  
Size: 145 mm

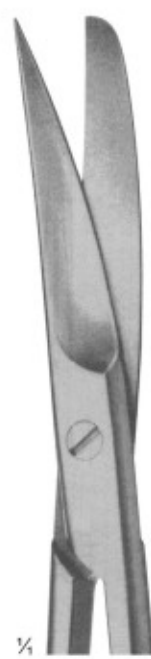

**2814**  
Size: 145 mm



**2815**  
Size: 145 mm

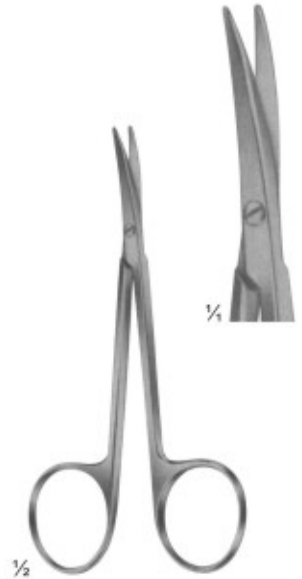

**2816**  
LITTLER  
Dissecting Scissors  
Size: 115 mm

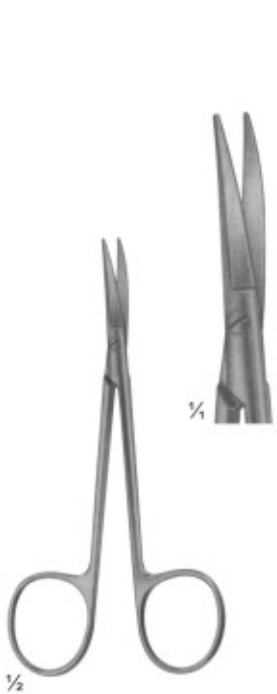

**2817**  
COTTLE  
Bulldog Scissors  
Size: 115 mm

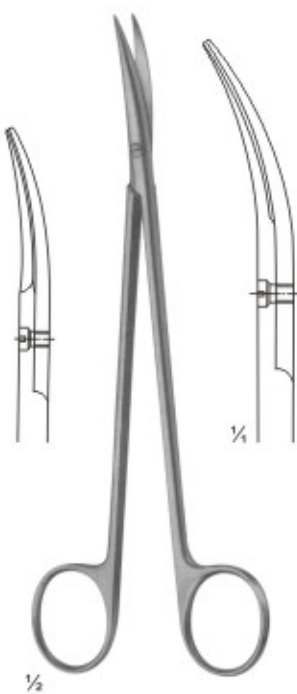

**2818**  
DE BAKEY  
Ateriotomy scissors  
Size: 175 mm

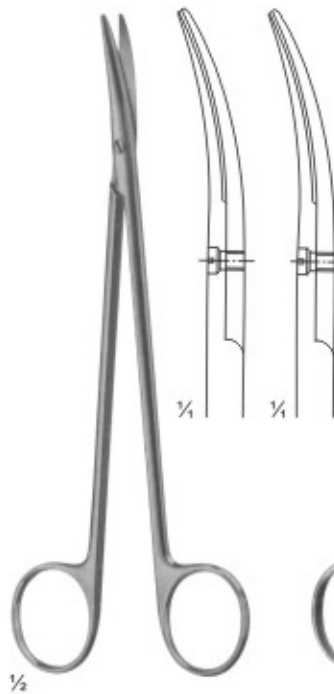

**2819**  
TOENNIS - ADSON  
Dissecting scissors  
Size: 175 mm

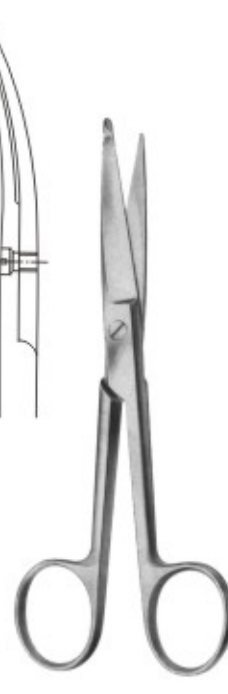

**2820**  
KNOWLES  
Size: 145 mm



**2821**  
LISTER



# Scissors

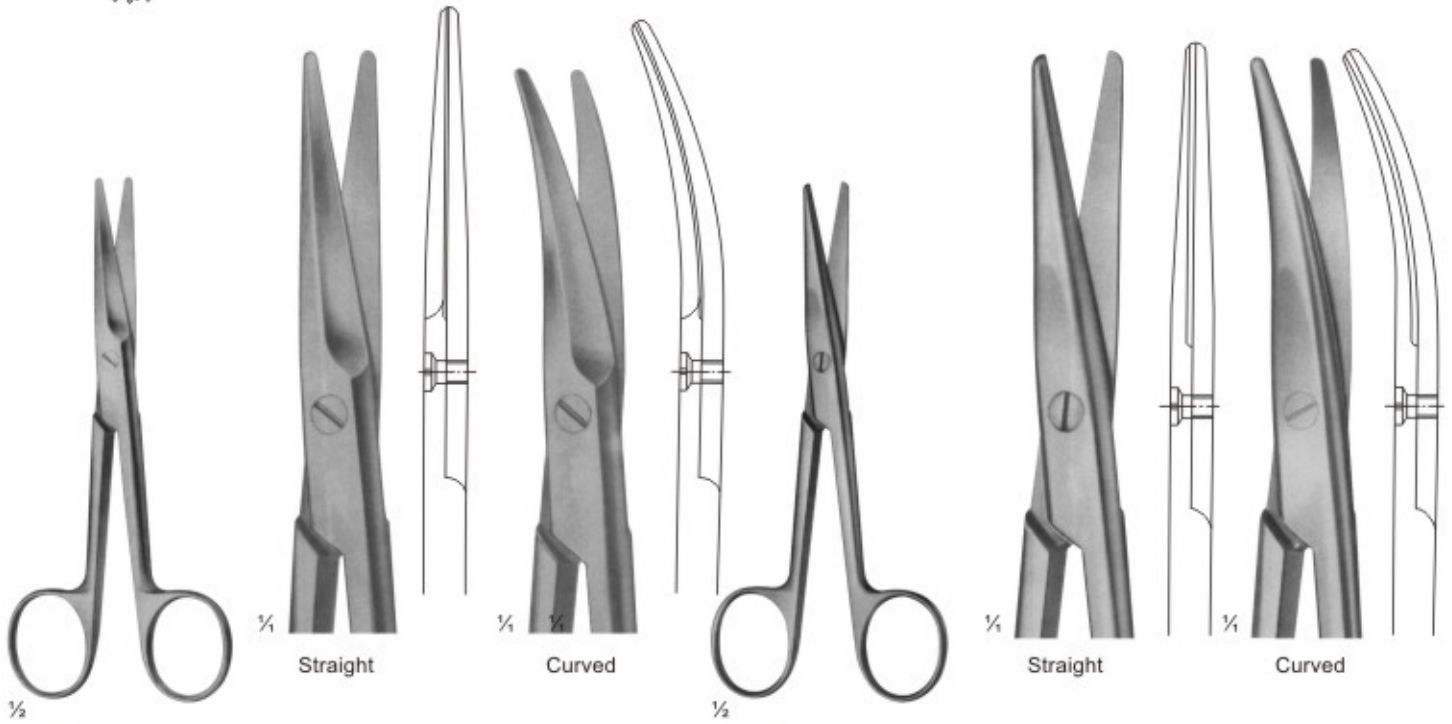

3/4  
**2822**  
MAYO (straight)  
Size: 140 mm

3/4  
**2823**  
MAYO-STILLE (straight)  
Size: 140 mm

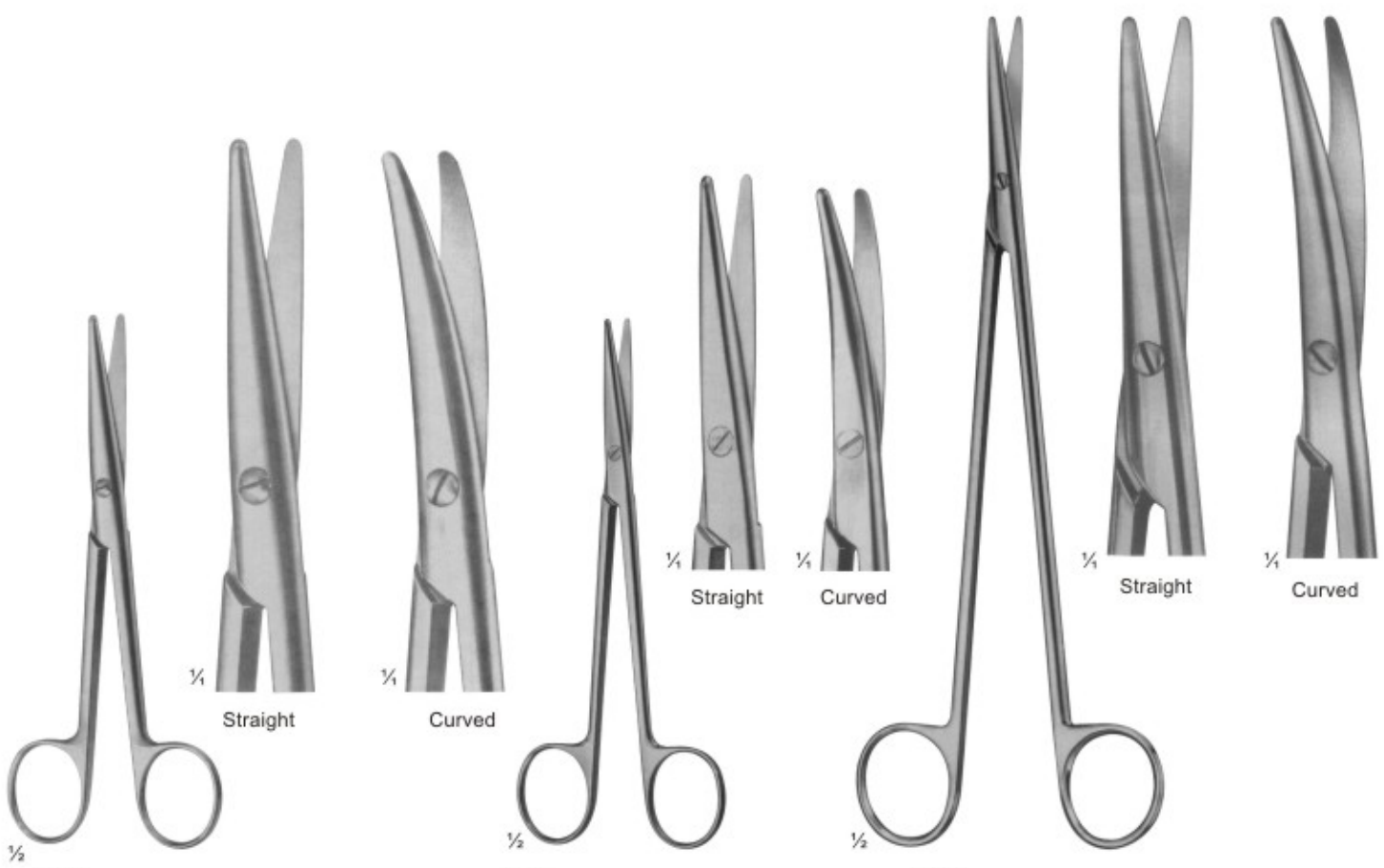

3/4  
**2824**  
STILLE  
Size: 140 mm

3/4  
**2825**  
METZENBAUM  
Size: 145 mm

3/4  
**2826**  
NELSON-METZENBAUM  
Size: 230 mm





# Scissors

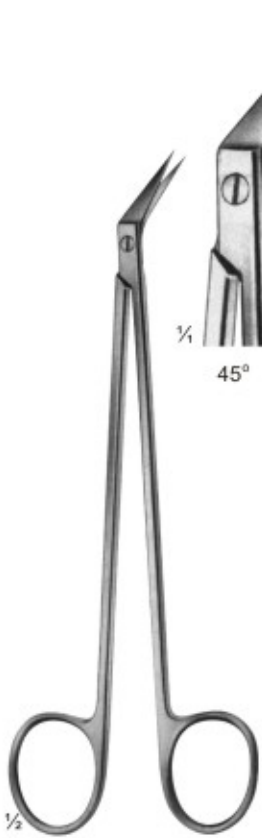

**2827**  
DE BAKEY  
Size: 155 mm



**2828**  
LOCKLIN  
Curved Sideways,  
1 Toothed Blade  
Size: 155 mm



**2829**  
LaGrange  
Double-Curved  
11.5 cm



**2830**  
Goldman-Fox  
Double-Curved  
13cm



**2831**  
SPENCER  
Size: 90 mm

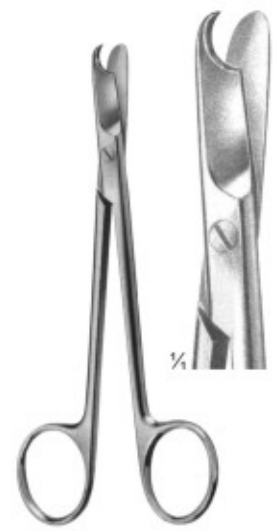

**2832**  
LITTAUER  
Size: 135 mm

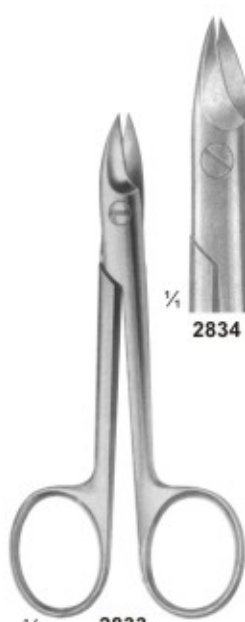

**2833**  
BEEBE  
Size: 110 mm

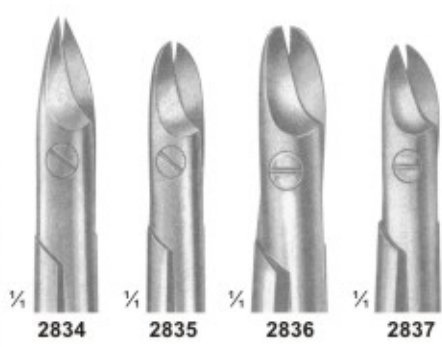

**2834**   **2835**   **2836**   **2837**



**2838**  
Dean  
17cm



**2839**  
1 Blade Serrated  
Size: 120 mm

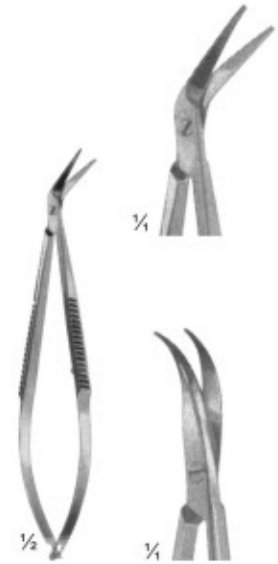

**2840**  
CASTROVIEJO  
Size: 90 mm



# Impression Trays



Made of 18/8 Stainless Steel, Solid, Set of 10

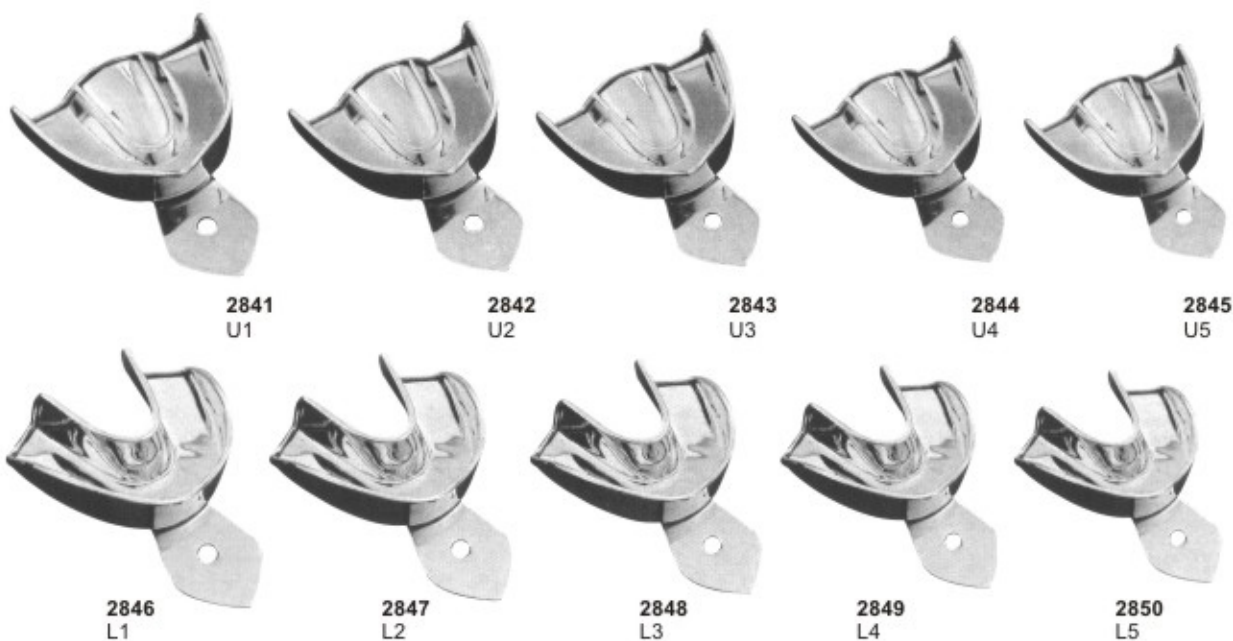

All The Above Impression Trays are Available in These 5 Sizes

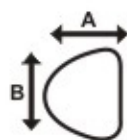

UPPER		U1	U2	U3	U4	U5
	A	62	60	53	54	52
B	83	75	73	69	68	

All Dimension are in mm

LOWER		L1	L2	L3	L4	L5
	A	63	61	57	60	53
B	82	81	78	74	71	

All Dimension are in mm

## Perforated, Set of 10

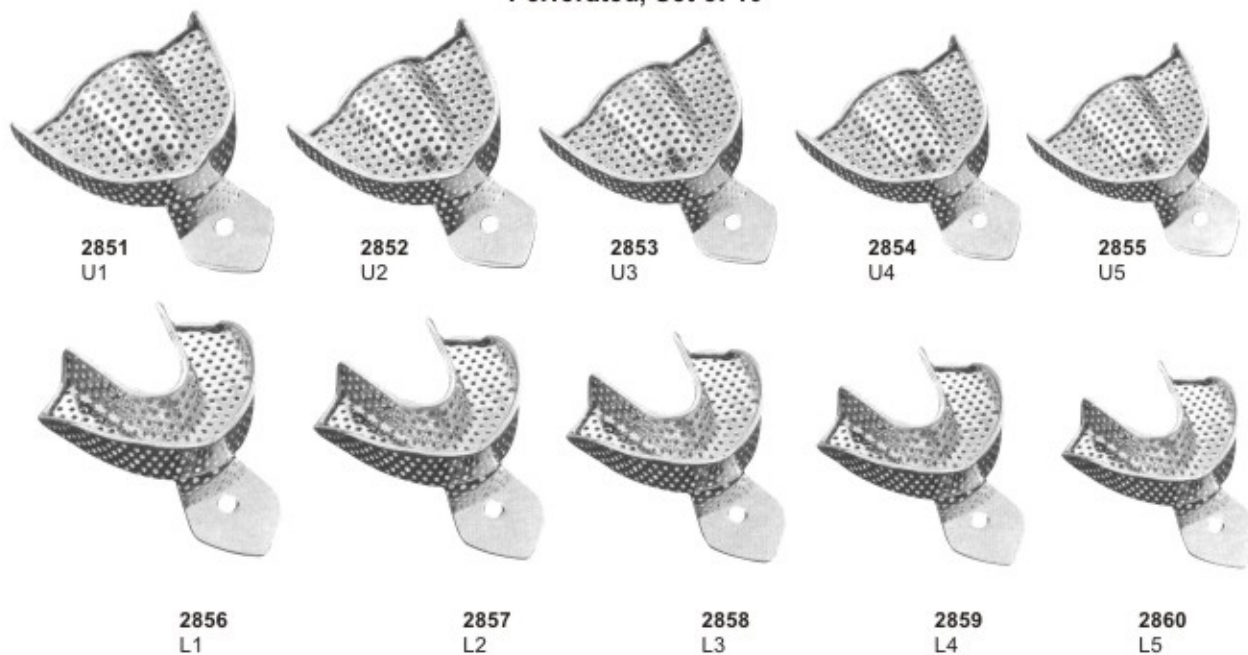





# Impression Trays



Made of 18/8 Stainless Steel, Solid Full Denture Set of 8

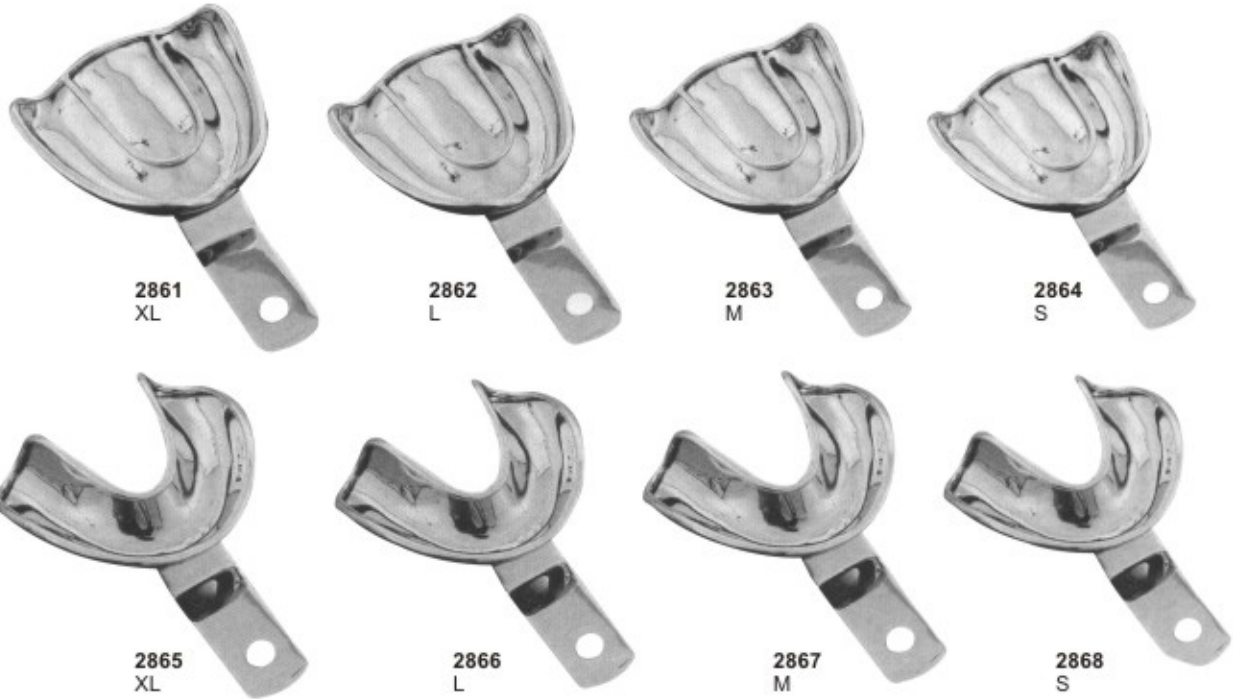

All The Above Impression Trays are Available in These 4 Sizes

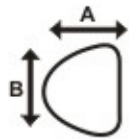

UPPER		XL	L	M	S
	A	70	67	64	60
B	79	76	70	73	

All Dimension are in mm

LOWER		XL	L	M	S
	A	64	64	60	57
B	86	70	73	70	

All Dimension are in mm

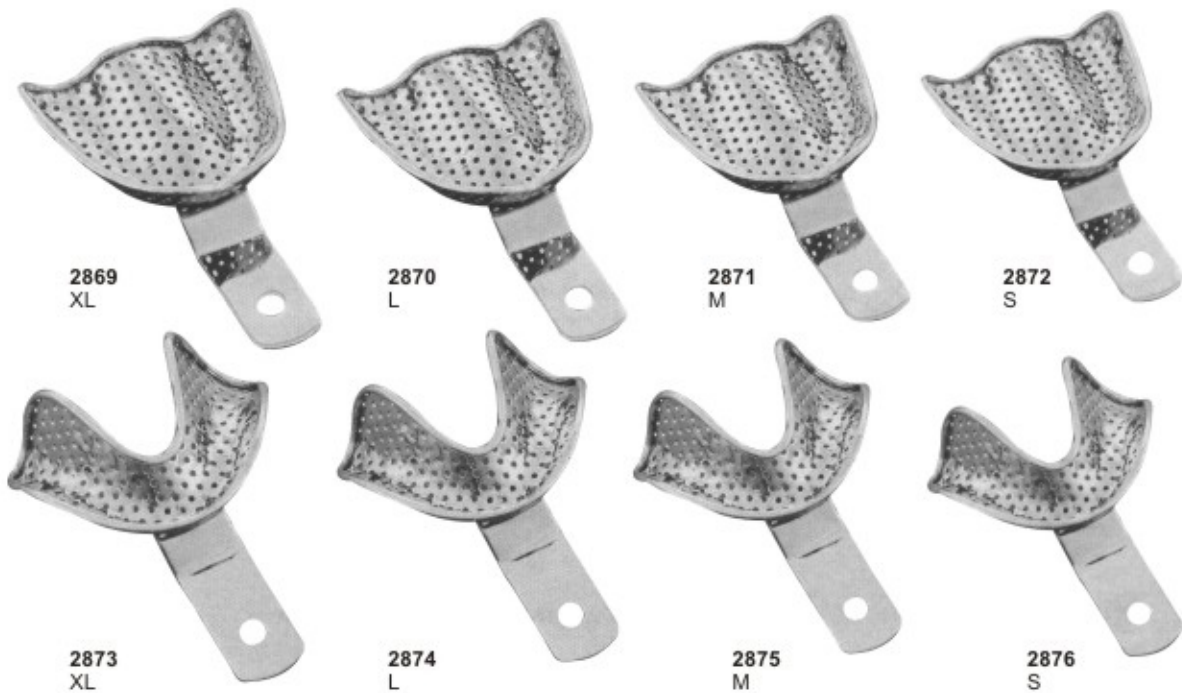

Perforated Full Denture Set of 8





# Impression Trays



Made of 18/8 Stainless Steel, Solid Set of 6



2877  
U1



2878  
U2



2879  
U3



2880  
L1



2881  
L2



2882  
L3

All The Above Impression Trays are Available in These 4 Sizes

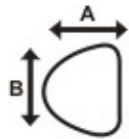

UPPER		U1	U2	U3
	A	67	64	57
B	81	71	70	

All Dimension are in mm

LOWER		L1	L2	L3
	A	60	57	54
B	81	79	76	

All Dimension are in mm

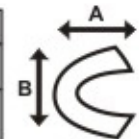

2883  
U1



2884  
7U2



2885  
U3



2886  
L1



2887  
L2



2888  
L3

Perforated Set of 6



## Extracting Forceps "English Pattern"



**1104**  
MEAD (MD 1)  
upper anteriors,  
roots, incisors, canines

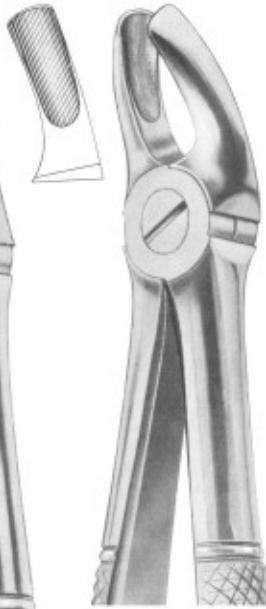

**1105**  
MEAD (MD 2)  
upper molars



**1106**  
MEAD (MD 3)  
lower roots

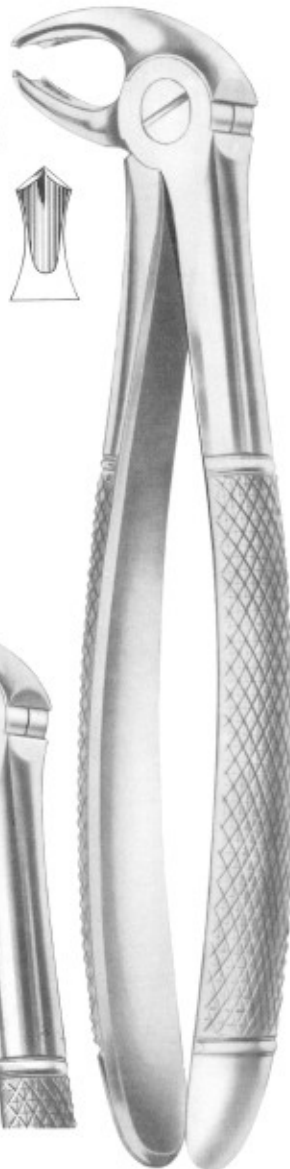

**1107**  
MEAD (MD 4)  
lower molars

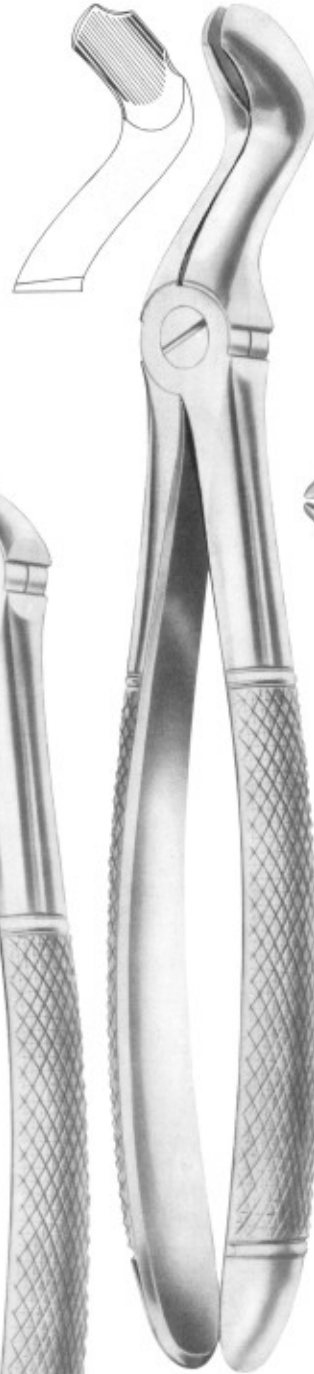

**1108**  
FELSCH (Fig. 210)  
upper third molars



**1109**  
HERTZ (Fig. 211)  
lower incisors



# Impression Trays



Made of 18/8 Stainless Steel, English Pattern Set of 8

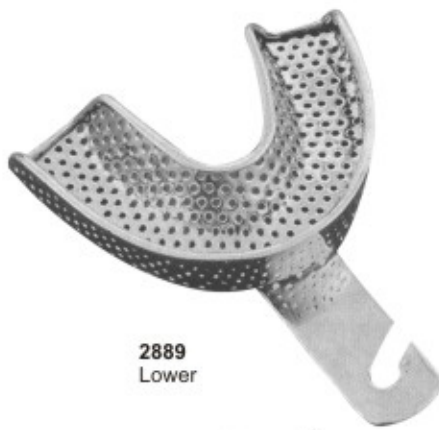

2889  
Lower



2890  
Upper

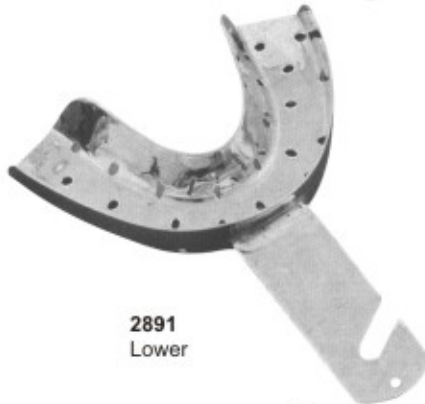

2891  
Lower



2892  
Upper



2893  
Lower



2894  
Upper

All The Above Impression Trays are Available in These 4 Sizes

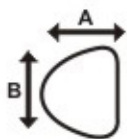

UPPER	Size	A	B	C
	0	67	50	12
	1	72	51	13
	2	78	55	15
	3	80	58	15

All Dimension are in mm

LOWER	Size	A	B	C
	0	70	50	14
	1	77	51	15
	2	79	55	15
	3	80	60	17

All Dimension are in mm







# Impression Trays



Made of 18/8 Stainless Steel, Solid Full Denture Set of 8



All The Above Impression Trays are Available in These 4 Sizes

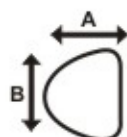

UPPER		XL	L	M	S
	A	70	67	64	60
B	79	76	70	73	

All Dimension are in mm

LOWER		XL	L	M	S
	A	64	64	60	57
B	86	70	73	70	

All Dimension are in mm

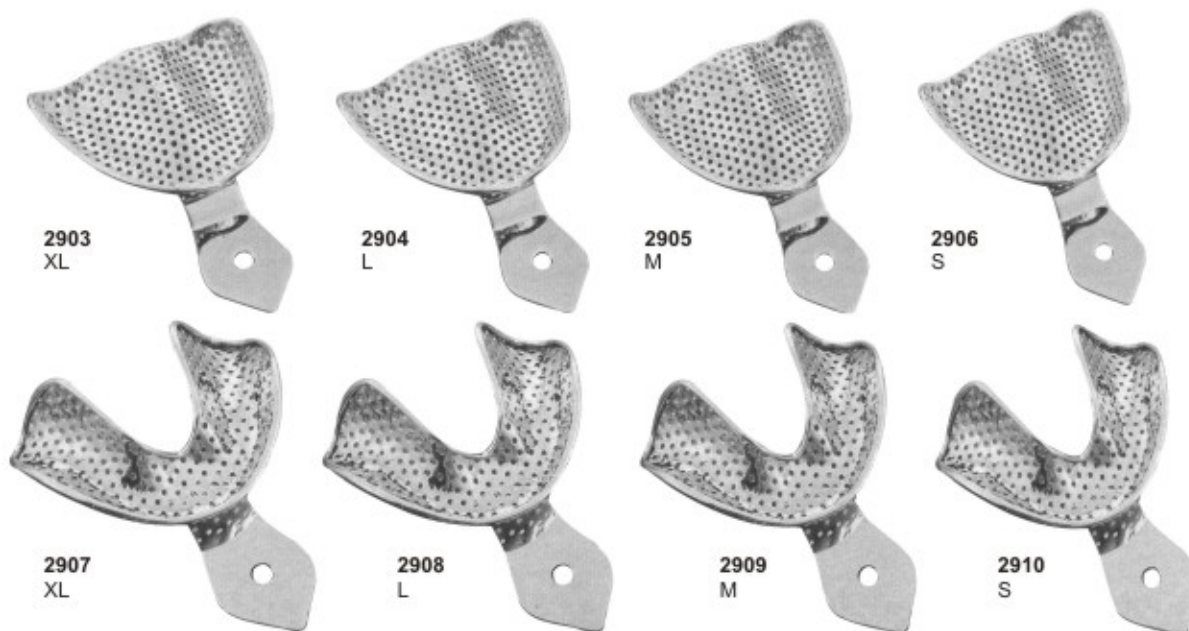

Made of 18/8 Stainless Steel, Perforated Full Denture Set of 8



## Impression Trays

Made of 18/8 Stainless Steel, Solid Full Denture Set of 8



2911  
U0



2912  
U1



2913  
U2



2914  
U3



2915  
L0



2916  
L1



2917  
L2



2918  
L3

Upper Sizes: 0,1,2,3

Depth of Tray: 15,9 mm, Height of Plate: 12,5 mm

Lower Sizes: 0,1,2,3

Depth of Tray: 12,9 mm

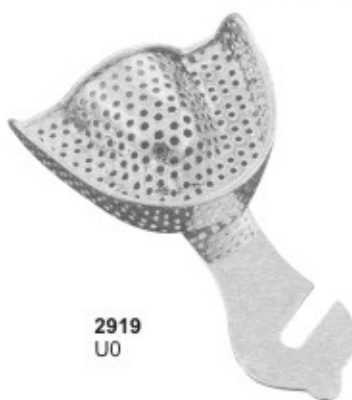

2919  
U0

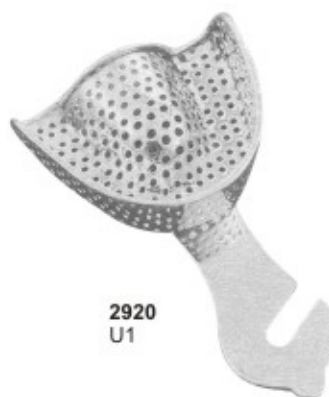

2920  
U1

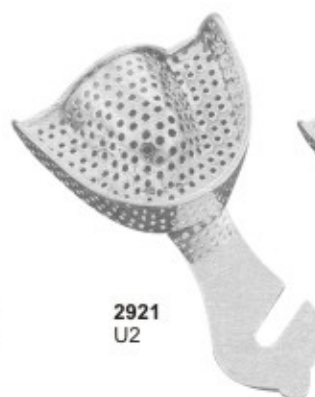

2921  
U2



2922  
U3



2923  
L0



2924  
L1

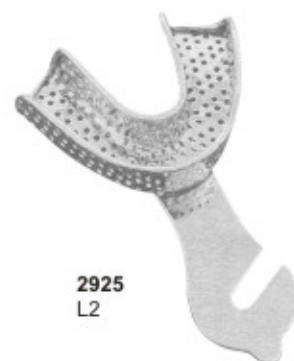

2925  
L2

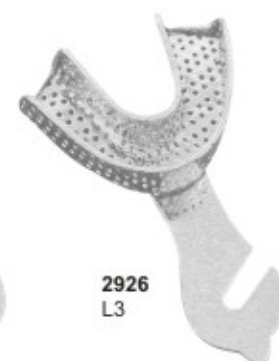

2926  
L3

Made of 18/8 Stainless Steel, Perforated Full Denture Set of 8





# Impression Trays



## Impression Trays For Crown & Bridge Work



2927  
U1P



2928  
L1P

**SOLID**



2929  
U1P

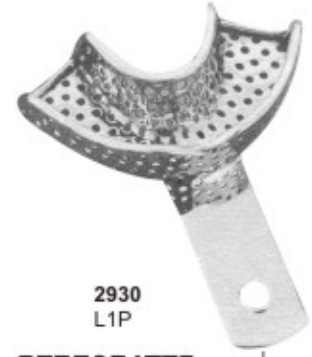

2930  
L1P

**PERFORATED**



2932  
Adjustable  
Perforated



2933  
Adjustable  
Solid

**PERFORATED**

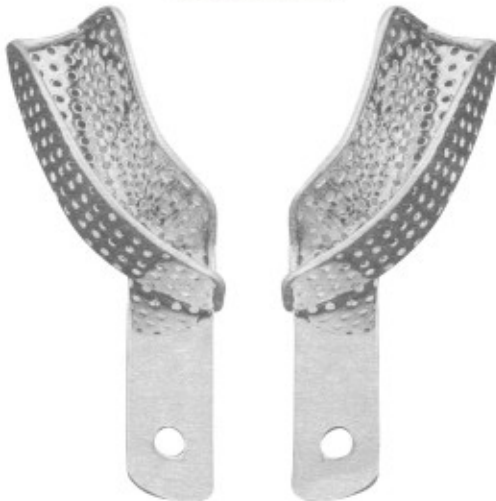

2931-A  
For upper right jaw  
For lower left jaw

2931-B  
For upper left jaw  
For lower right jaw

- Available in 4 sizes**
- 1.....44 mm
  - 2.....55 mm
  - 3.....60 mm
  - 4.....65 mm

**SOLID**



2931-C  
For upper right jaw  
For lower left jaw

2931-D  
For upper left jaw  
For lower right jaw

- Available in 4 sizes**
- 1.....44 mm
  - 2.....55 mm
  - 3.....60 mm
  - 4.....65 mm





# Articulators



2934



2935



2936



2937



2939



2938



## Articulators

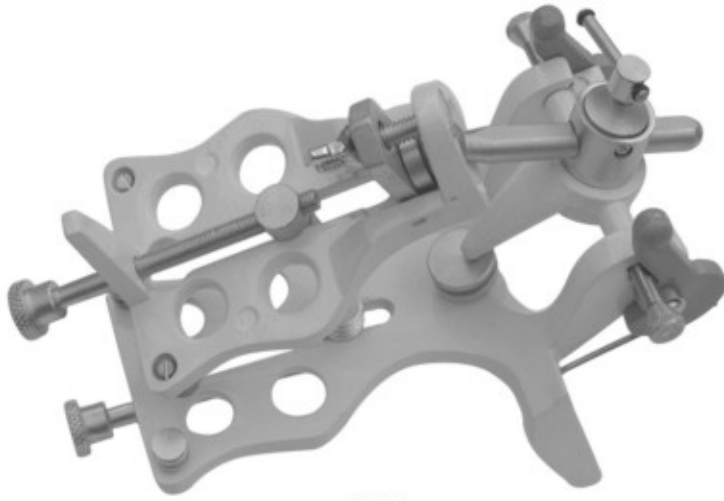

2940



2941



2942



2943



2944



2945



2946



2947



# Hollow Wares



**2948**  
Instruments Tray of 20 Pcs

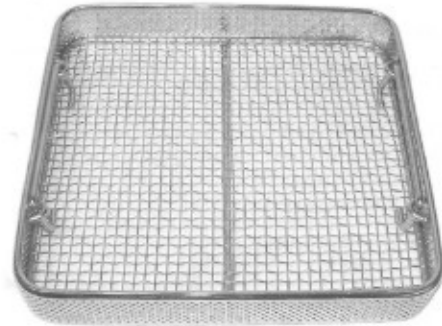

**2951**  
Instruments Riddle



**2949**  
Instruments Tray of 7 Pcs



**2949-A**  
Instruments Tray of 10 Pcs



**2950**  
Instruments Tray of 5 Pcs

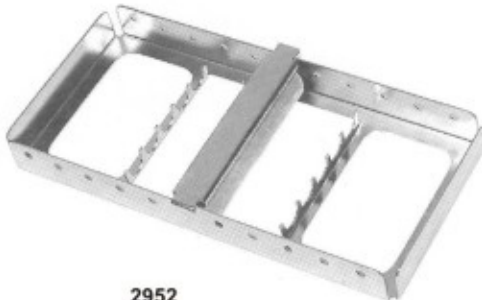

**2952**  
Instruments Tray of 5 Pcs

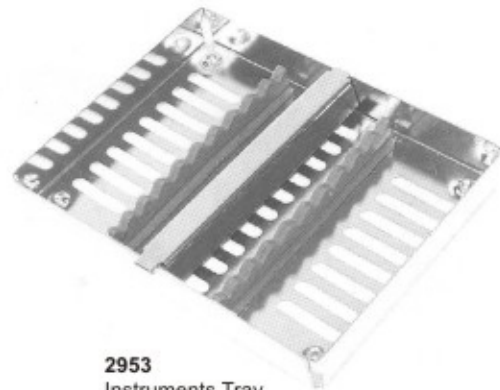

**2953**  
Instruments Tray



**2954**  
Instruments Tray  
Perforated



**2955**  
Instruments Tray  
Perforated Base



**2956**  
Instruments Tray  
Solid Base





# Hollowares

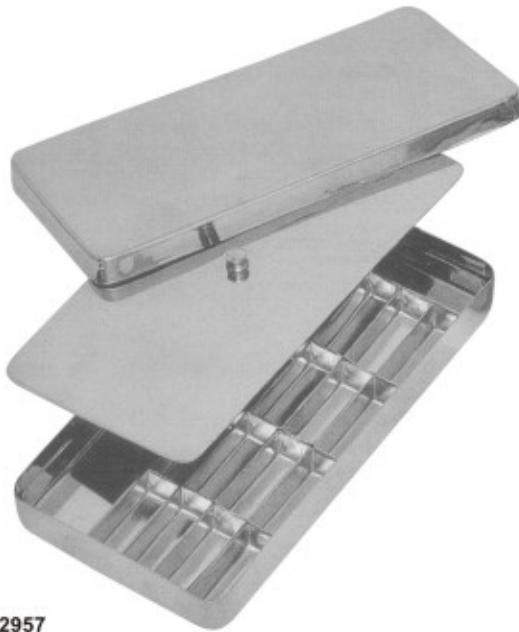

**2957**  
Pulpectomy Tray



**2958**  
Sterilizing Box  
Available Sizes:  
17x17x3 cm  
20x10x6 cm  
30x14x6 cm



**2959**  
Endo Tray Box



**2960**  
Finger Cup



**2961**  
Bur Box

**2962**  
Sterilizing Drum  
150x150mm  
175x175mm  
190x190mm  
200x140mm  
200x200mm  
240x120mm  
225x225mm  
240x240mm  
290x160mm



**2963**  
Sterilizing Drum  
280x240mm  
230x150mm  
300x250mm  
340x160mm  
350x250mm  
390x200mm  
380x300mm  
100x100mm  
150x120mm



## Sterilizing Boxes & Instruments Trays



**2964**  
Instruments Box



**2965**  
Instruments Box



**2966**  
Instruments Box



**2967**  
Instruments Sterilizer  
150x75 mm



**2968**  
Endodontic Box



**2969**  
Sterilizing Box  
320x120 mm



**2970**  
Instruments Tray



**2971**  
Instruments Tray



**2972**  
Instruments Tray  
(Perforated)



**2973**  
Instruments Tray  
Shallow(Mayo)



**2974**  
Scaler Tray  
20.0 x 10.0 x 1.5 cm



**2975**  
Scalers Tray



**2976**  
Scalers Tray



## Hollow Wares



2977

2978

2979

2980

Forcep and Thermometer Jars



2981

Cotton Holding Jar  
60x50 mm



2982  
Spitten Mug



2983  
Spirit Burner With Wick  
Stainless Steel 18/10  
Capacity: 150 ml, 60 ml



2984  
Spirit Burners With Wick  
Stainless Steel 18/10  
Capacity: 70ml



2985  
Dressing Jar



2986  
Dressing Jar



2987  
Irrigator (Douch Can)



2988  
Measuring Jug





## Wisdom Extracting Forceps



**1110**  
ROUTURIER (Fig. 212)  
( 22 ½ L )  
lower molars  
and wisdom left



**1111**  
ROUTURIER (Fig. 213)  
( 22 ½ R )  
lower molars  
and wisdom right



**1112**  
ROUTURIER (Fig. 214)  
( 22 ½ L )  
lower molars  
and wisdom left



**1113**  
ROUTURIER (Fig. 215)  
( 33 ½ R )  
lower molars  
and wisdom right



**1114**  
RESECTION FORCEPS  
( 216/Witzel )  
upper roots



# Hollow Wares



**2989**  
Sponge Bowl



**2990**  
Wash Basin  
300mm-350mm-400mm



**2994**  
Kick Bucket With Trolley



**2991**  
Sponge Bowl



**2992**  
Gallipot



**2993**  
Medicine Cup



**2995**  
Kidney Tray Shallow  
150mm-200mm-240mm-300mm



**2996**  
Kidney Tray Without Lid  
150mm-200mm-250mm-300mm



**2997**  
Kidney Tray With Lid  
150mm-200mm-250mm-300mm



**2998**  
Tube Rack, Stainless Steel 18/10



**2999**  
Needle Case Rectangle  
Needle Case Round With Cover  
90x15



**3000**  
Dustbin Without Stand  
6-10-12 Ltr



**3001**  
Tube Rack, Round Model  
Stainless Steel 18/10



**3002**  
Dustbin Without Stand & Cap  
6-10-12 Ltr



**3003**  
Lotion Bowl With Lip  
40-60-80-100-120-150-180-200mm



## Scissors With Tungsten Carbide Inserts



**3004**  
Standard

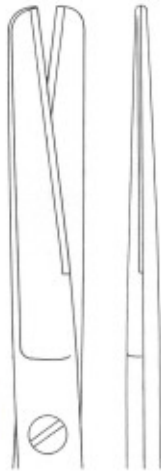

14,5cm  
16,5cm  
18,5cm



**3005**  
Standard



14,5cm  
16,5cm  
18,5cm



**3006**  
Standard

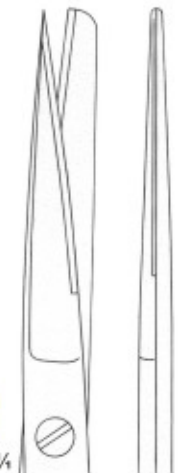

14,5cm  
16,5cm  
18,5cm



**3007**  
Standard



14,5cm  
16,5cm  
18,5cm



**3008**  
Standard



14,5cm  
16,5cm  
18,5cm



**3009**  
Standard



14,5cm  
16,5cm  
18,5cm





# Scissors With Tungsten Carbide Inserts

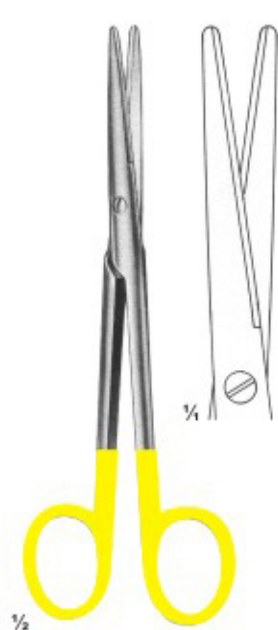

**3010**  
MAYO-LEXER  
Straight  
16 cm

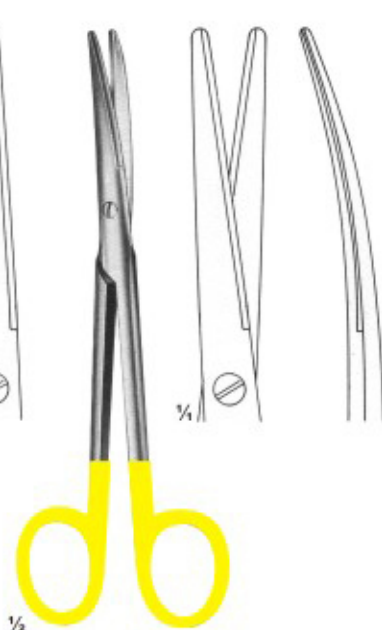

**3011**  
MAYO-LEXER  
Curved  
16 cm



**3012**  
LEXER  
Straight  
16, 21 cm



**3013**  
LEXER  
Curved  
16, 21 cm

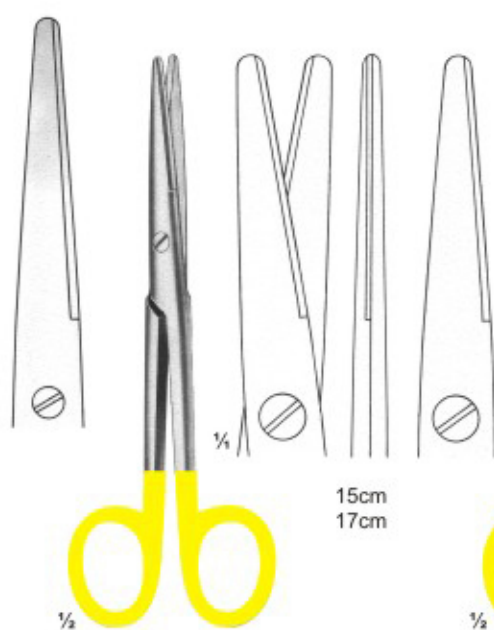

**3014**  
MAYO-STILLE  
Straight  
15, 17 cm

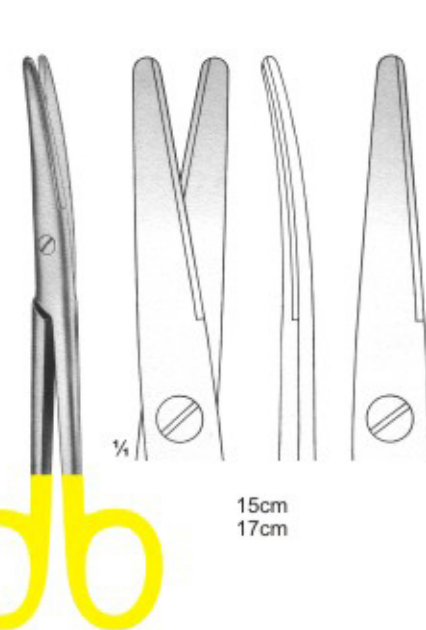

**3015**  
MAYO-STILLE  
Curved  
15, 17 cm



# Scissors With Tungsten Carbide Inserts



18cm	11,5cm
20cm	14,5cm
28cm	23,5cm
30cm	25,5cm

**3016**  
METZENBAUM  
Straight



11,5cm	14,5cm
23cm	25cm

**3017**  
METZENBAUM  
Curved

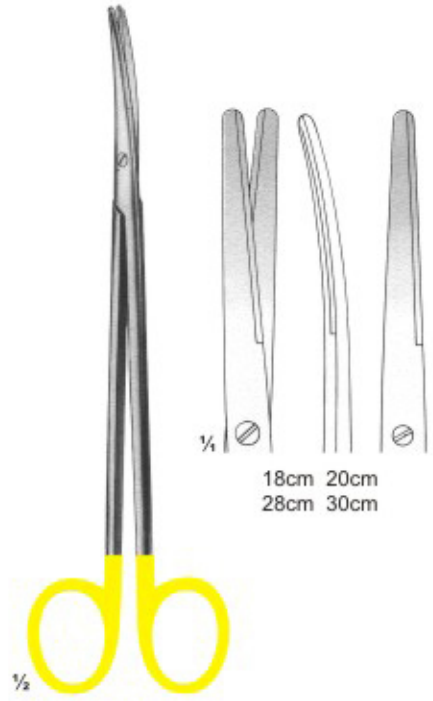

18cm	20cm
28cm	30cm

**3018**  
METZENBAUM  
Curved



14cm	18cm	20cm
23cm	25cm	28cm

**3019**  
METZENBAUM FINO  
Straight



14cm	18cm	20cm
23cm	25cm	28cm

**3020**  
METZENBAUM FINO  
Curved



14cm	18cm
20cm	23cm

**3021**  
METZENBAUM FINO  
Sharp

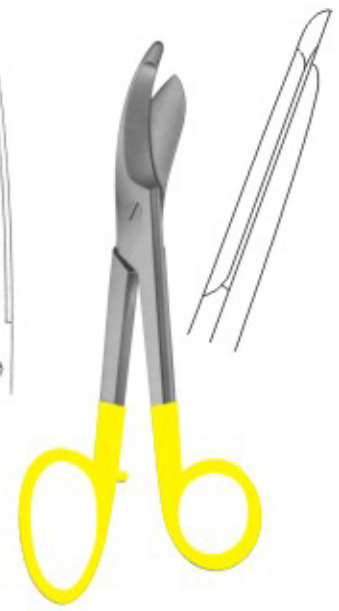

**3022**  
BRUNS  
235 mm



# Scissors With Tungsten Carbide Inserts

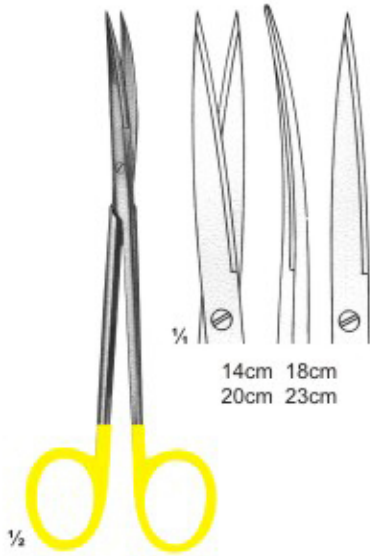

**3023**  
METZENBAUM FINO

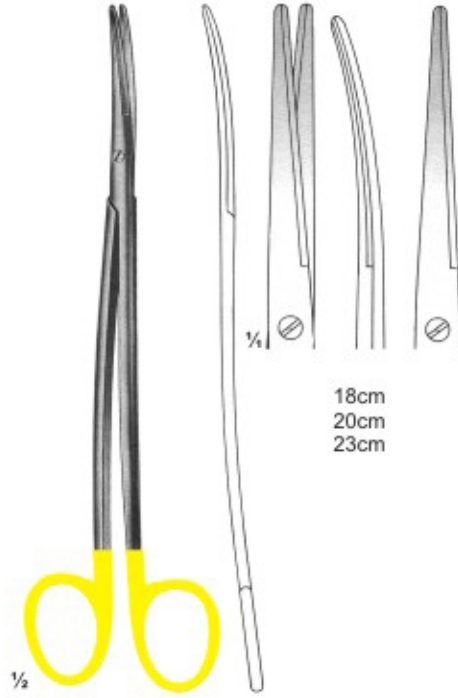

**3024**  
METZENBAUM FINO

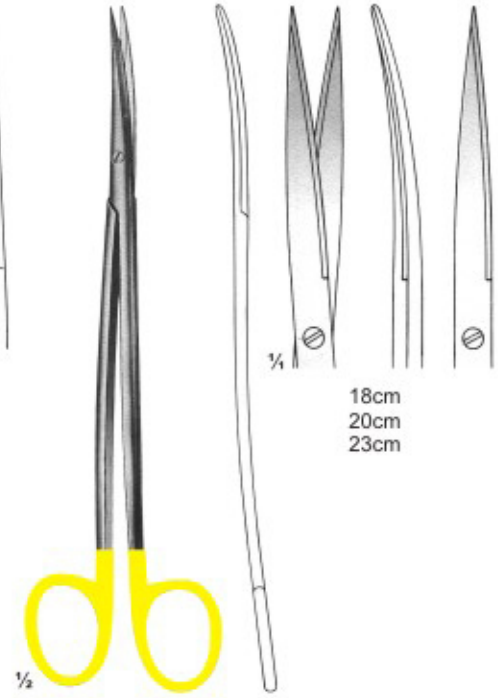

**3025**  
METZENBAUM FINO

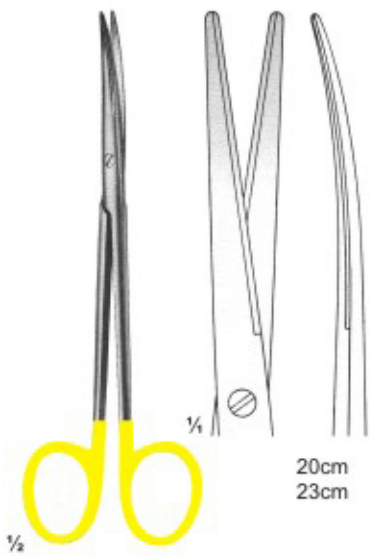

**3026**  
METZENBAUM FINO

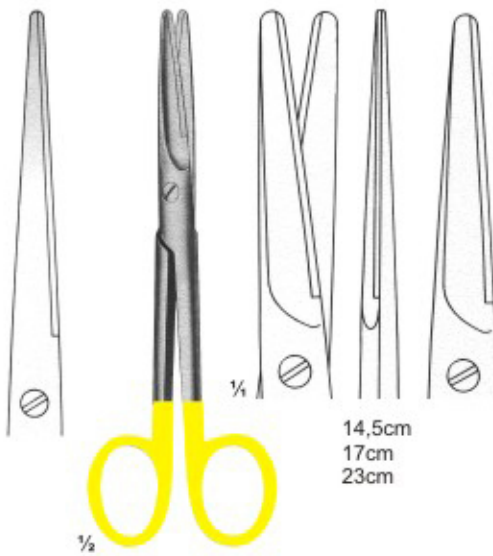

**3027**  
MAYO  
Straight

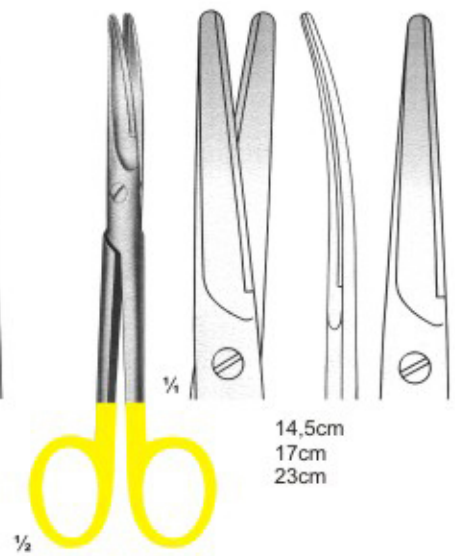

**3028**  
MAYO  
Curved





## Scissors With Tungsten Carbide Inserts

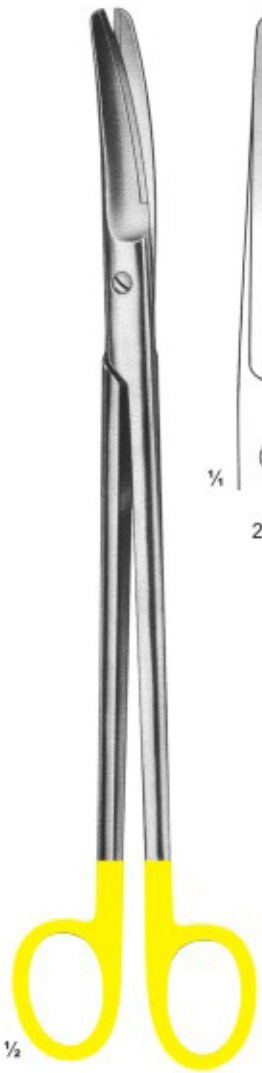

**3029**  
SIMS

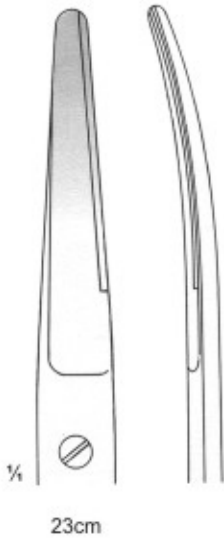

23cm

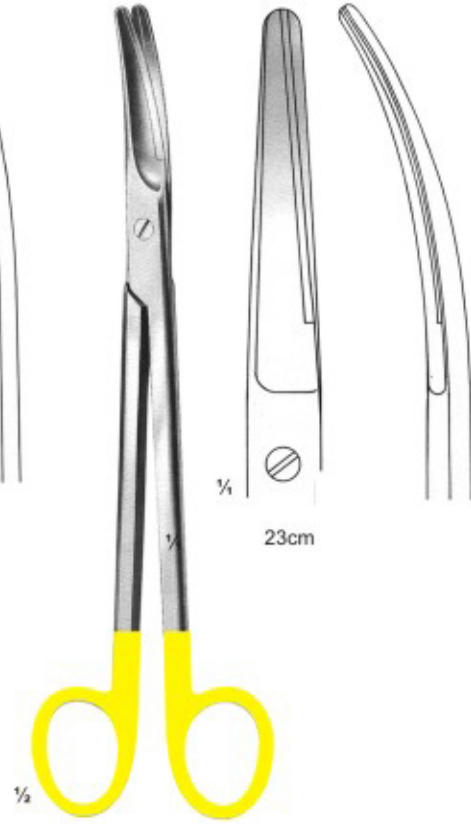

**3030**  
PARAMETRIUM

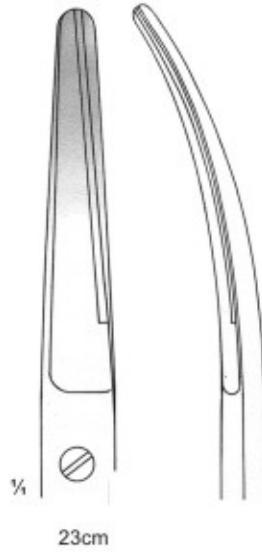

23cm

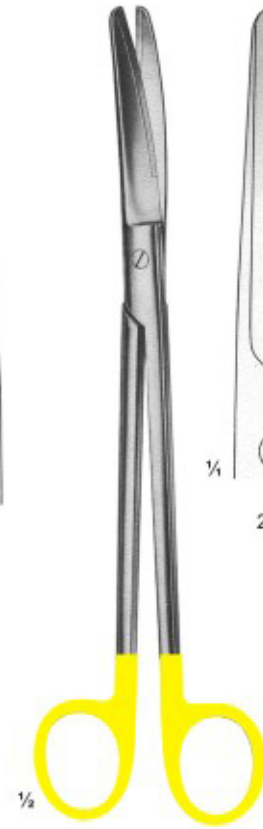

**3031**  
MAYO-HARRINGTON

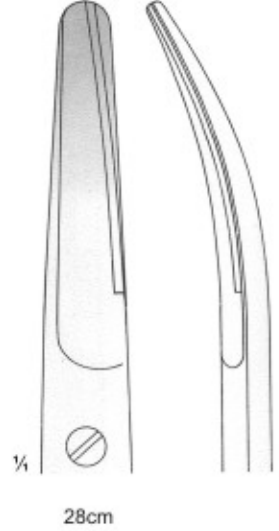

28cm



**3032**  
KELLY  
Straight 16 cm



**3033**  
KELLY  
Curved 16 cm



**3034**  
DEAN  
17 cm



**3035**  
LAGRANGE  
Double-Curved  
11.5 cm



# Scissors With Tungsten Carbide Inserts

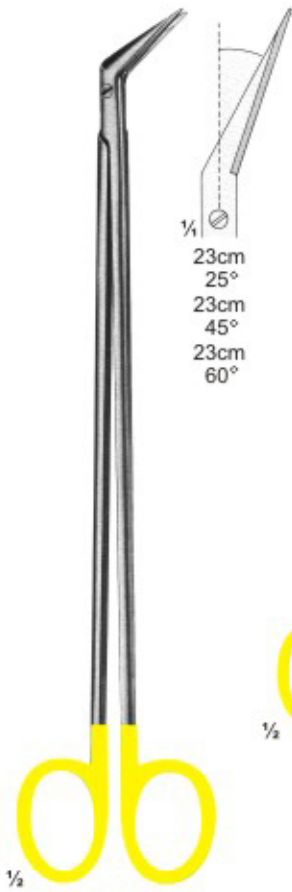

**3036**  
DE-BAKEY



**3037**  
DE-BAKEY

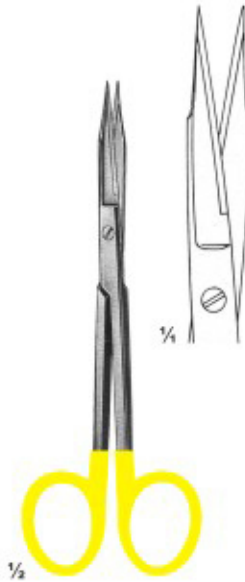

**3038**  
GOLDMAN FOX  
13 cm



**3039**  
GOLDMAN FOX  
Double-Curved  
13 cm

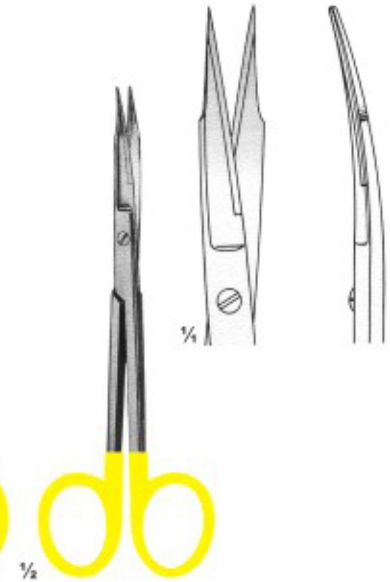

**3040**  
GOLDMAN FOX  
13 cm



**3041**  
Fine Scissors  
Straight  
11, 5 cm

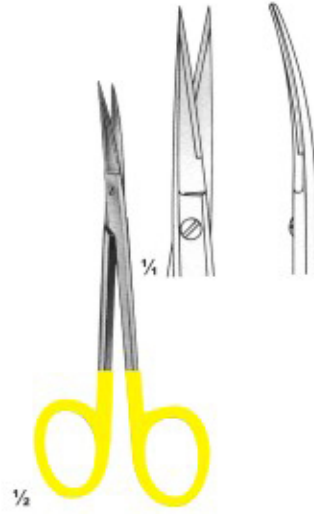

**3042**  
Fine Scissors  
Curved  
11, 5 cm

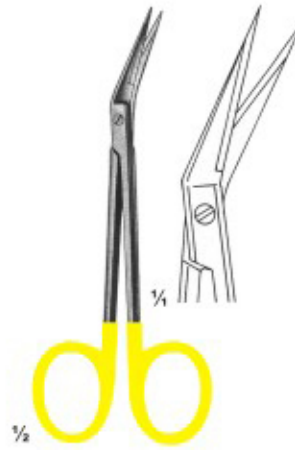

**3043**  
Fine Scissors  
Angled  
11, 5 cm



**3044**  
RAGNELL  
Curved  
12 cm



# Scissors & Dissecting Forceps With Tungsten Carbide Ins

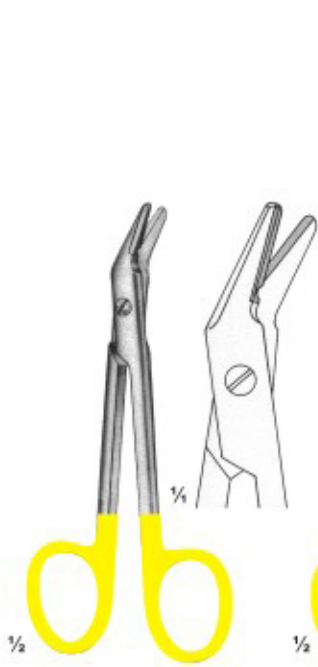

**3045**  
UNIVERSAL  
12cm



**3046**  
Ligature Scissors  
1 Black & 1 Goldplated ring



**3047**  
MERIAM  
16 cm



**3048**  
ADSON

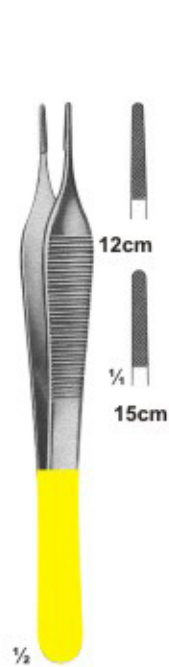

**3049**  
ADSON



**3050**  
CUSHING  
17,5 cm

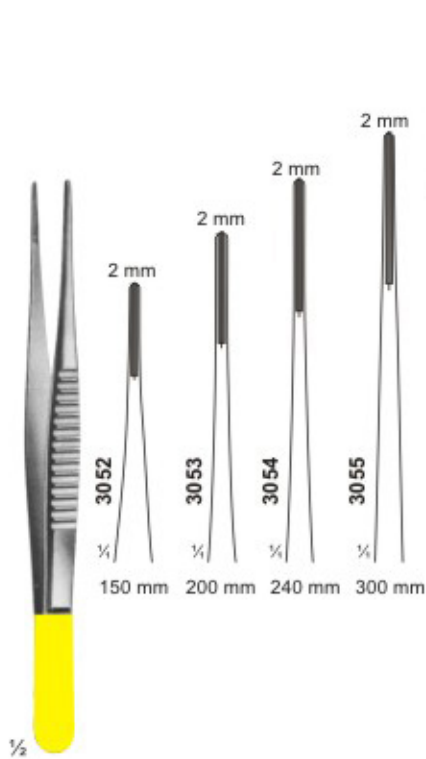

**3051**  
DE BAKEY  
17,5 cm



**3056**  
CASTROVIEJO  
Curved  
15 cm



**3057**  
CUSHING  
18 cm



**3058**  
CUSHING-  
TAYLOR  
18 cm

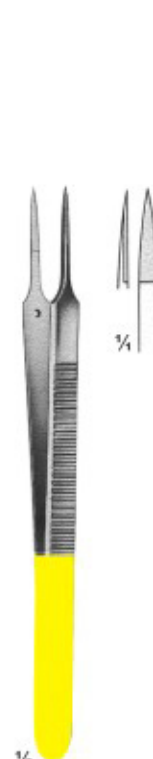

**3059**  
Dressing  
Forceps  
15 cm



**3060**  
SEMKEN  
15 cm













**3061**

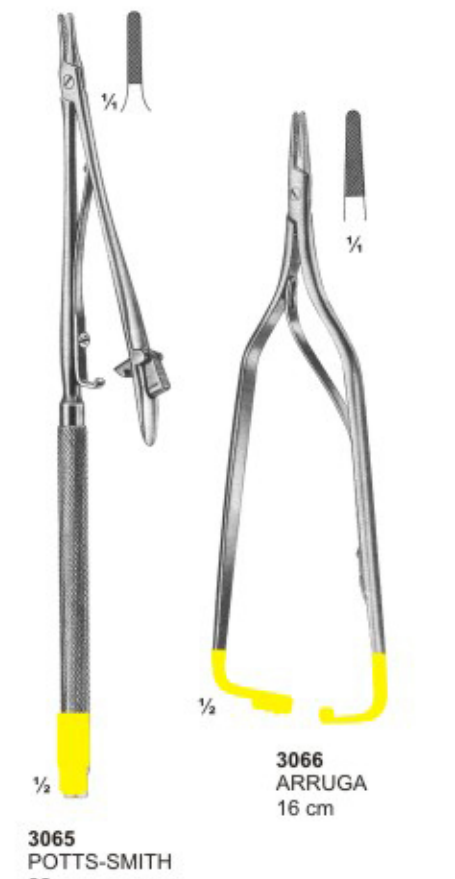



# Dissecting Forceps & Needle Holders T.C Instrume



 <p>15cm 23cm 25cm</p> <p><b>3062 WANGENSTEEN</b></p>	 <p>15cm 18cm 20cm 23cm 25cm</p> <p><b>3063 POTTS-SMITH</b></p>	 <p>14cm 20cm 16cm 25cm 18cm 30cm</p> <p><b>3064 OEHLER</b></p>	 <p><b>3065 POTTS-SMITH</b> 22 cm</p> <p><b>3066 ARRUGA</b> 16 cm</p>				
 <p><b>3067 HEPP-SCHIEDLE</b> 18 cm</p>	 <p><b>3068 KALT</b> with catch 135 mm</p>	 <p><b>3069 CASTROVIEJO</b> Straight 14 cm</p>	 <p><b>3070 CASTROVIEJO</b> Curved 14 cm</p>	 <p><b>3071 CASTROVIEJO</b> Straight 14 cm</p>	 <p><b>3072 CASTROVIEJO</b> Curved 14 cm</p>	 <p><b>3073 CASTROVIEJO</b> Straight</p>	 <p><b>3074 CASTROVIEJO</b> Straight</p>



# Needle Holders With T.C. Inserts

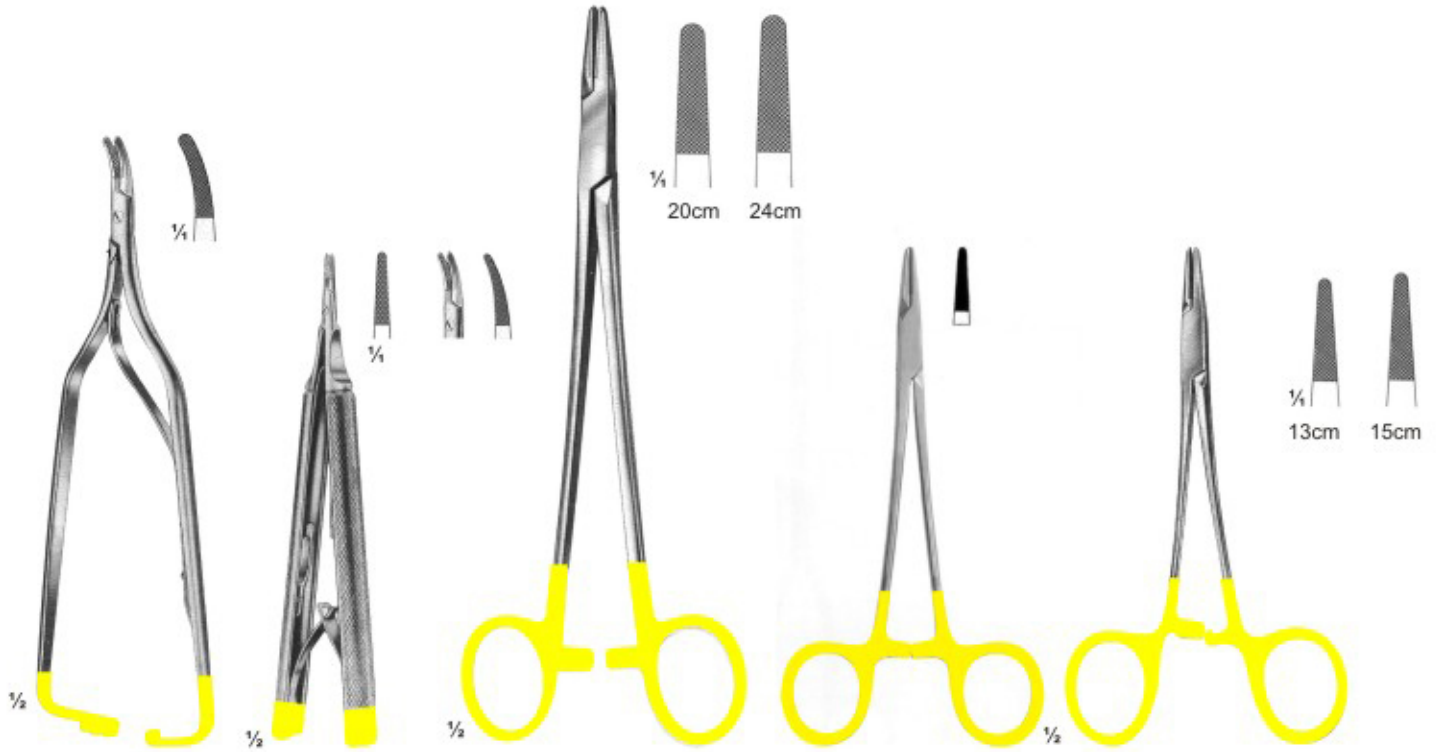

**3075**  
ARRUGA  
Curved  
16 cm

**3076**  
CASTROVIEJO  
13 cm

**3077**  
HEGAR  
20,24 cm

**3078**  
SMOOTH TIP  
15 cm

**3079**  
HALSEY  
13,15 cm

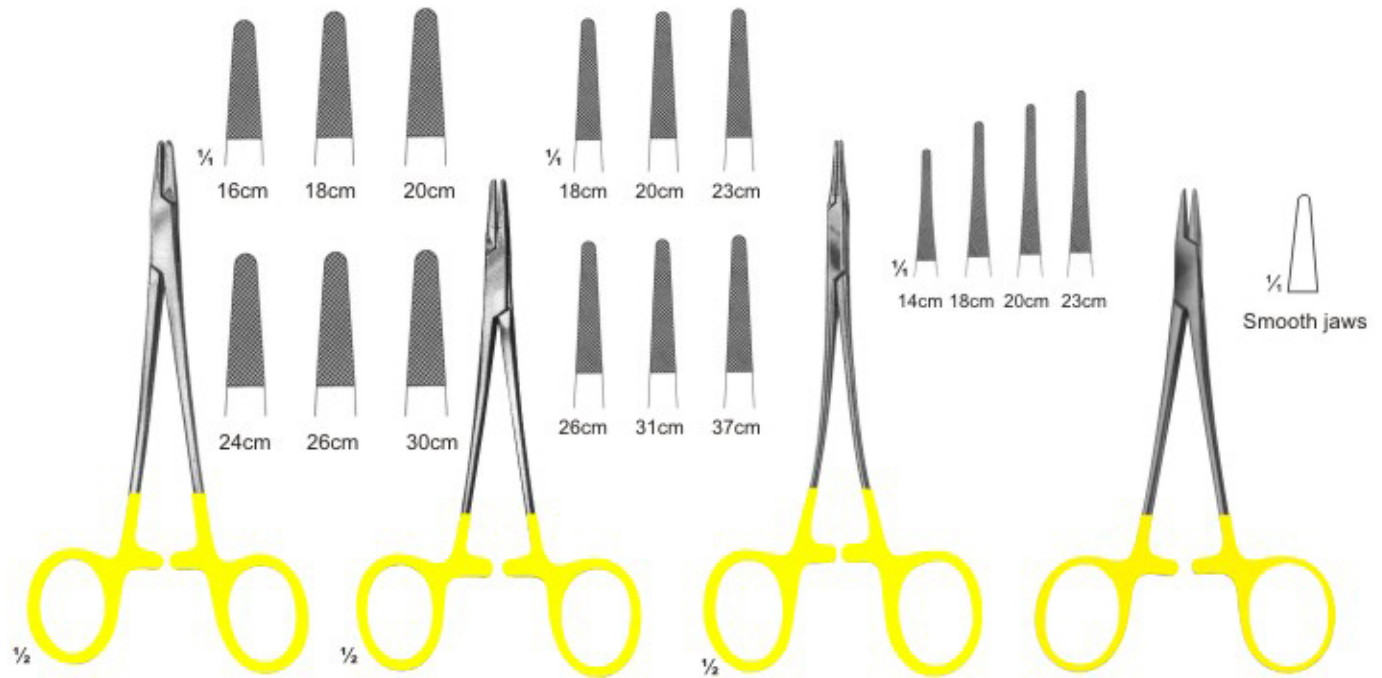

**3080**  
MAYO-HEGAR

**3081**  
DE BAKEY

**3082**  
HEGAR-VASCULAR

**3083**  
WEBSTER  
125 mm



## Extracting Forceps "English Pattern"



**1115**  
Fig. 5



**1116**  
Fig. 6

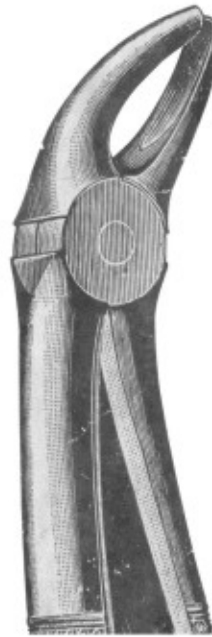

**1117**  
Fig. 9



**1118**  
Fig. 10



**1119**  
Fig. 11



**1120**  
Fig. 12



**1121**  
Fig. 14



**1122**  
Fig. 15





# Needle Holders With Tungsten Carbide Inserts

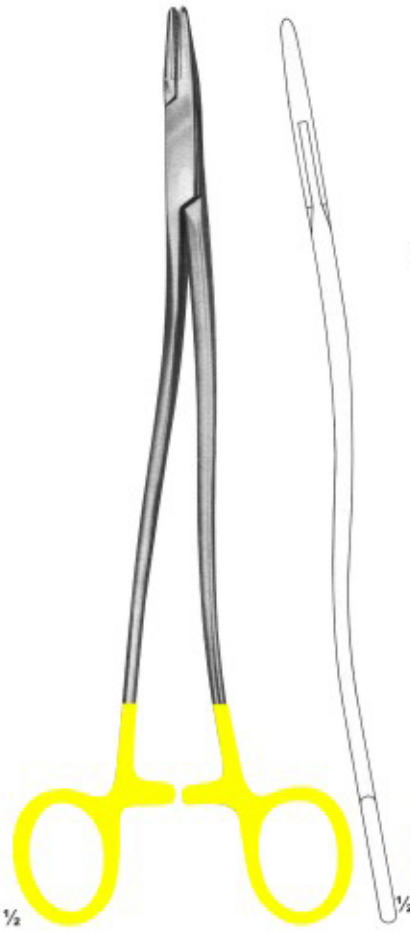

**3084**  
BOZEMANN-WERTHEIM  
20, 24, 26 cm

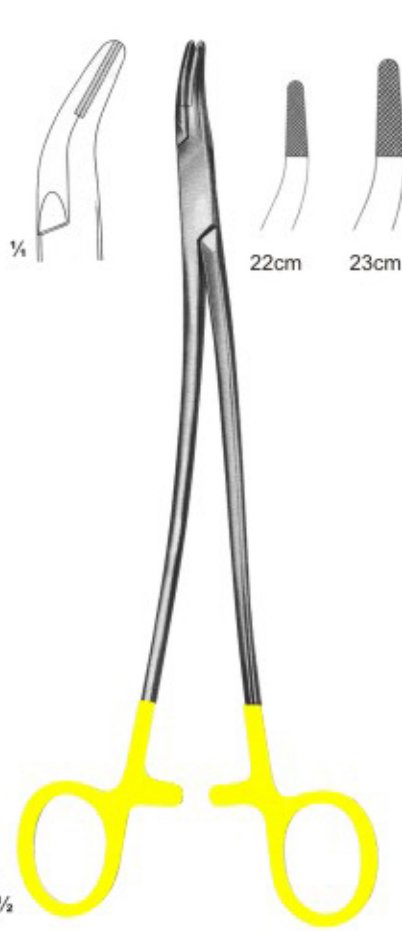

**3085**  
STRATTE

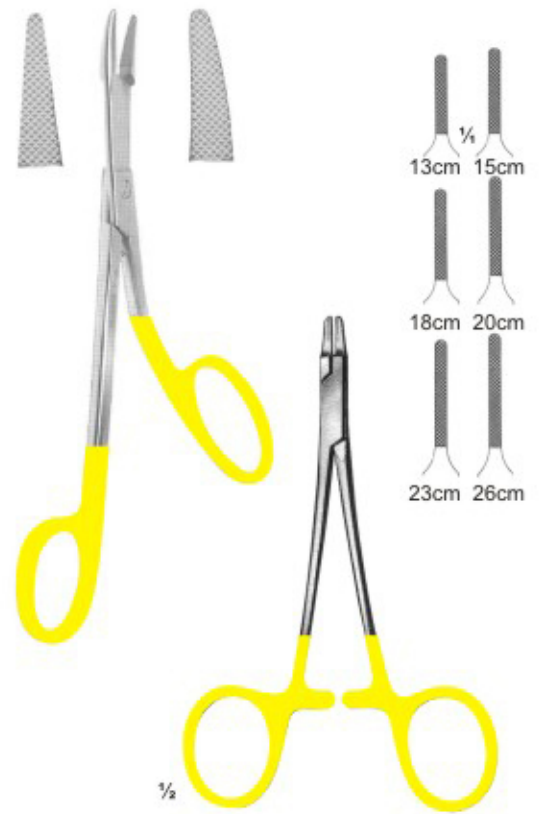

**3086**  
RYDER



**3087**  
RYDER-VASCULAR

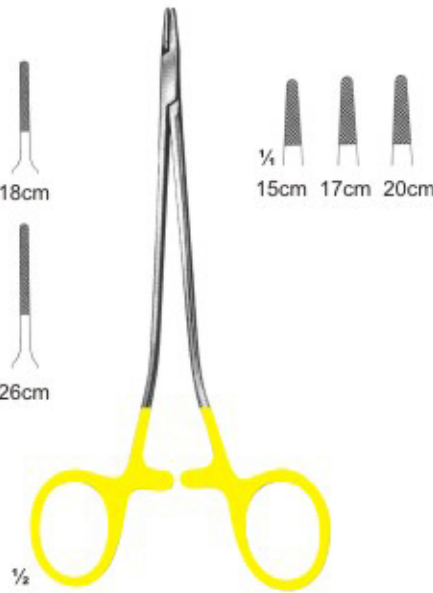

**3088**  
MARTIN

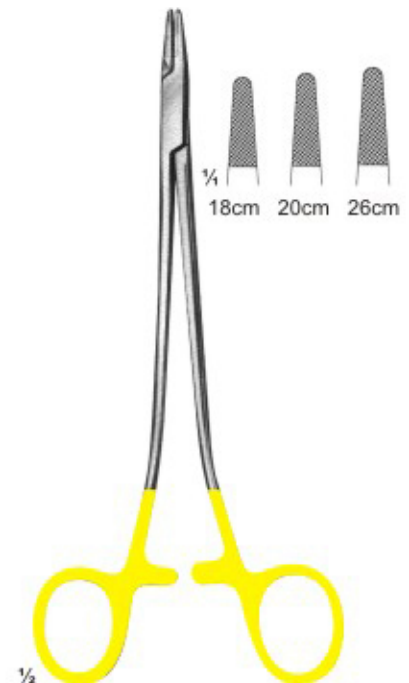

**3089**  
SAROT



# Needle Holders With Tungsten Carbide Inserts

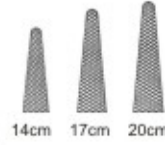

**3090**  
FINOCHIETTO  
27 cm

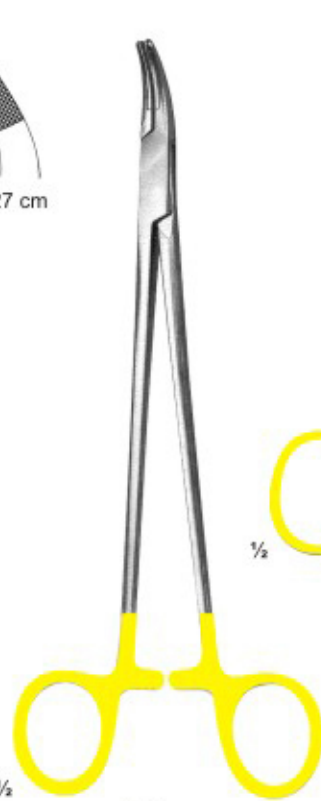

**3091**  
HEANEY  
27,24 cm



**3092**  
BAUMGARTNER  
145 mm



**3093**  
CRILE-WOOD  
15 cm



**3094**  
MATHIEU



**3095**  
MATHIEU  
14,17,20 cm



**3096**  
MATHIEU-KOSHER  
14,17,20,24 cm



**3097**  
MATHIEU-KOSHER  
17,20,24 cm



**3098**  
MATHIEU-VASCULAR  
17,20,24 cm



**3099**  
MATHIEU-VASCULAR  
Hosel  
17,20 cm



## Needle Holders With T.C. Inserts

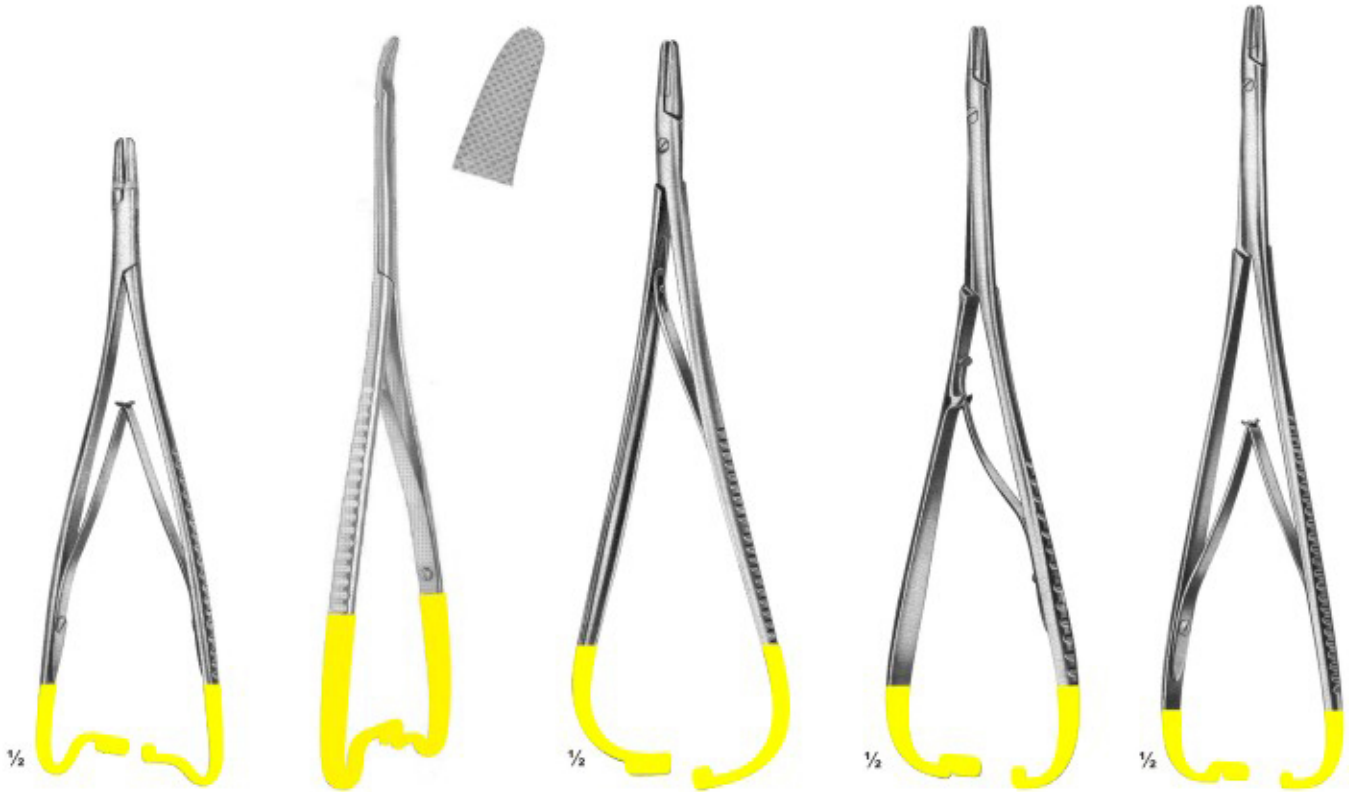

1/2  
**3100**  
MATHIEU-RYDER  
17,20,24 cm

**3101**  
Hosel  
Curved  
20 cm

1/2  
**3102**  
LICHTENBERG  
20 cm

1/2  
**3103**  
LANGHALS  
20,25 cm

1/2  
**3104**  
LICHTENBERG  
20,25 cm

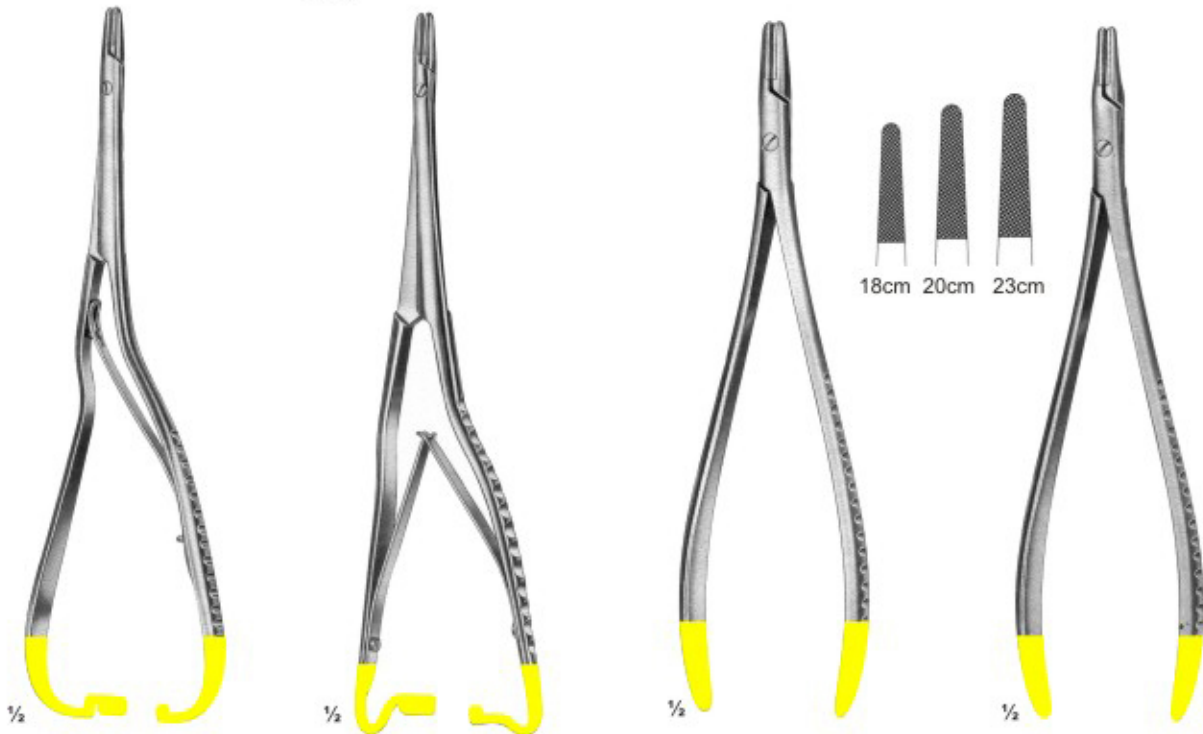

1/2  
**3105**  
LUEHTY-BECK  
20,25 cm

1/2  
**3106**  
LUEHTY-BECK  
20,25 cm

1/2  
**3107**  
LANGENBECK  
18,20,23 cm

1/2  
**3108**  
LANGENBECK  
18,20,23 cm





## Wire Cutting Plier With T.C. Inserts



**3109**  
TOENNIS  
Elastic pattern for  
dura-or intestinal suture  
180 mm



**3110**  
Cutting Plier  
12 cm

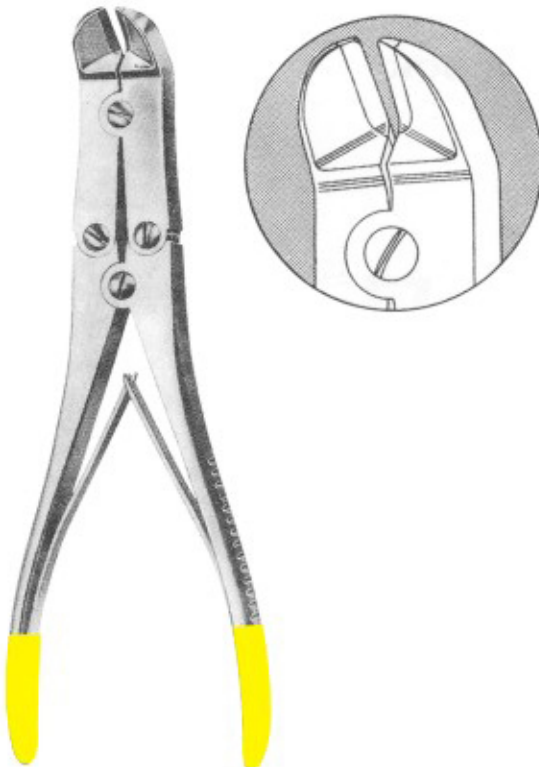

**3111**  
MULLAR CLAUS  
22 cm



**3112**  
Plier  
17.5 cm



## Extracting Forceps “English Pattern”



1123  
Fig. 25



1124  
Fig. 26



1125  
Fig. 27



1126  
Fig. 28

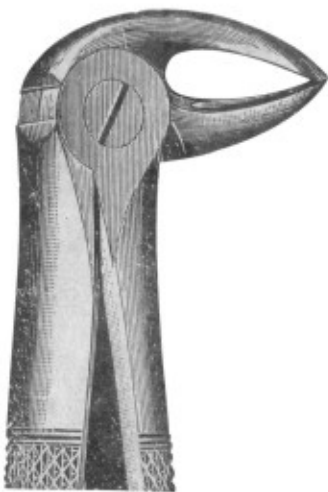

1127  
Fig. 34



1128  
Fig. 35

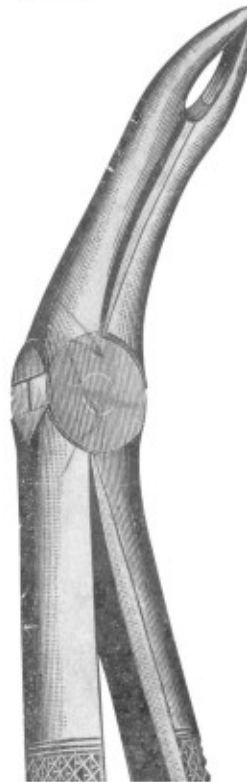

1129  
Fig. 42

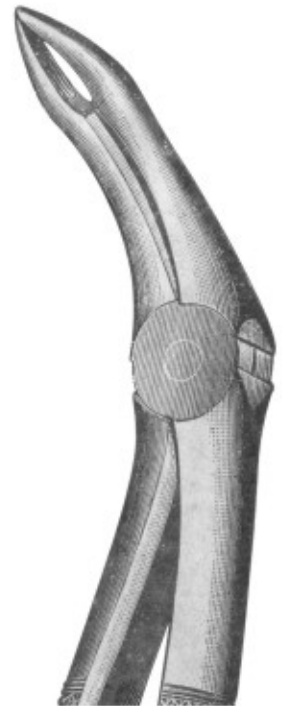

1130  
Fig. 43



## Extracting Forceps “English Pattern”



**1131**  
Fig. 44A



**1132**  
Fig. 46

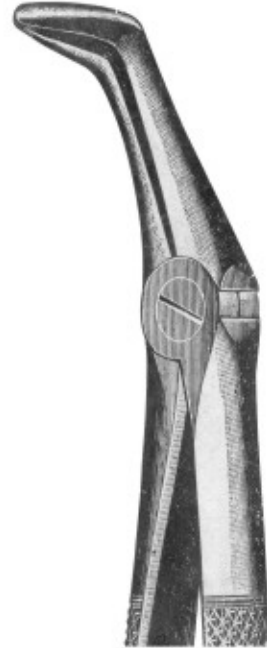

**1133**  
Fig. 47

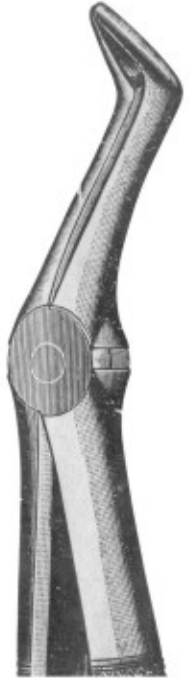

**1134**  
Fig. 50A



**1135**  
Fig. 74R



**1136**  
Fig. 74L



**1137**  
Fig. 75R



**1138**  
Fig. 75L





## Extracting Forceps "English Pattern"



1139  
Fig. 94

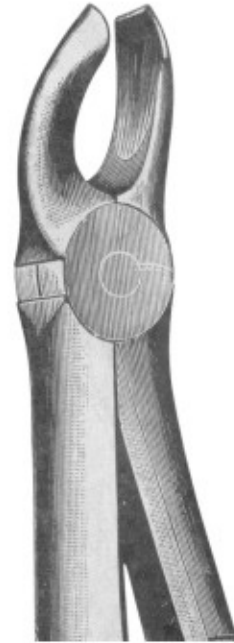

1140  
Fig. 95



1141  
Fig. 98



1142  
Fig. 105



1143  
Fig. 106



1144  
Fig. 2002



## Extracting Forceps “With Fitting Handle”



**1145**  
Fig. 1  
upper laterals  
and canines



**1146**  
Fig. 2  
upper laterals  
and canines



**1147**  
Fig. 3  
upper incisors  
and canines

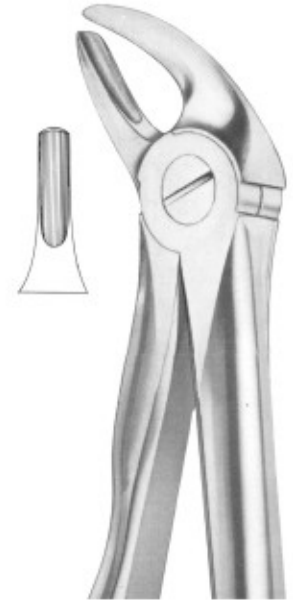

**1148**  
Fig. 4  
lower incisors  
and canines



**1149**  
Fig. 7  
upper premolars

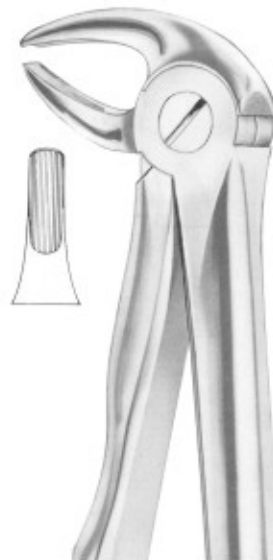

**1150**  
Fig. 13  
lower premolars



**1151**  
Fig. 13S  
lower premolars  
for children



## Extracting Forceps “With Fitting Handle”



**1152**  
Fig. 17  
upper molars right



**1153**  
Fig. 18  
upper molars left



**1154**  
Fig. 18A  
upper molars



**1155**  
Fig. 18B  
upper molars



**1156**  
Fig. 19  
upper third molars



**1157**  
Fig. 22  
lower molars



**1158**  
Fig. 22S  
lower molars  
for children





## Extracting Forceps “With Fitting Handle”



**1159**  
Fig. 29  
upper roots



**1160**  
Fig. 29S  
upper roots  
for children



**1161**  
Fig. 30  
upper roots



**1162**  
Fig. 30S  
upper roots  
for children

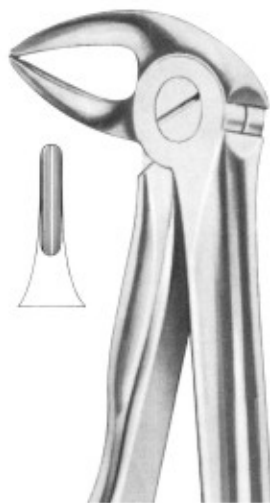

**1163**  
Fig. 33  
lower roots



**1164**  
Fig. 33A  
lower roots

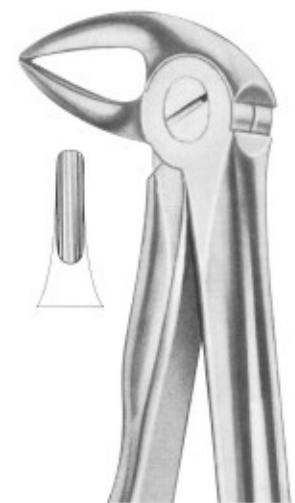

**1165**  
Fig. 33B  
lower roots



## Extracting Forceps "With Fitting Handle"



**1166**  
Fig. 33L  
lower roots



**1167**  
Fig. 33S  
lower roots  
for children



**1168**  
Fig. 37  
upper incisors  
for children



**1169**  
Fig. 39  
upper incisors  
for children



**1170**  
Fig. 39A  
upper molars  
for children



**1171**  
Fig. 39R  
upper molars right  
for children



**1172**  
Fig. 39L  
upper molars left  
for children



## Extracting Forceps "With Fitting Handle"



**1173**  
Fig. 41  
upper roots

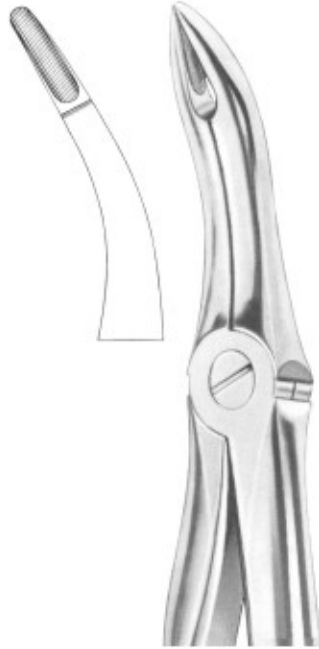

**1174**  
Fig. 44  
upper roots

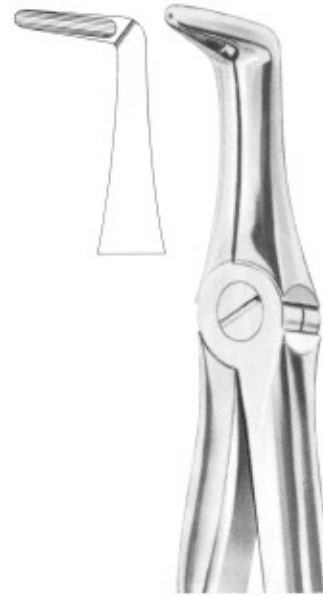

**1175**  
Fig. 45  
lower roots

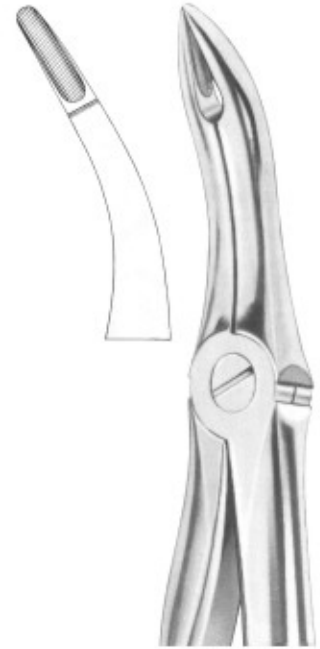

**1176**  
Fig. 48  
lower roots



**1177**  
Fig. 51  
upper roots



**1178**  
Fig. 51A  
upper roots



**1179**  
Fig. 51S  
upper roots  
for children





## Extracting Forceps "With Fitting Handle"



**1180**  
Fig. 51L  
upper roots

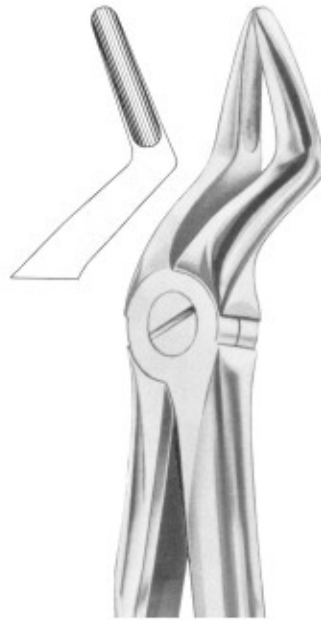

**1181**  
Fig. 52  
upper roots



**1182**  
Fig. 54  
for separating  
upper molars



**1183**  
Fig. 65R  
upper molars right



**1184**  
Fig. 65L  
upper molars left



**1185**  
Fig. 67  
upper third molars

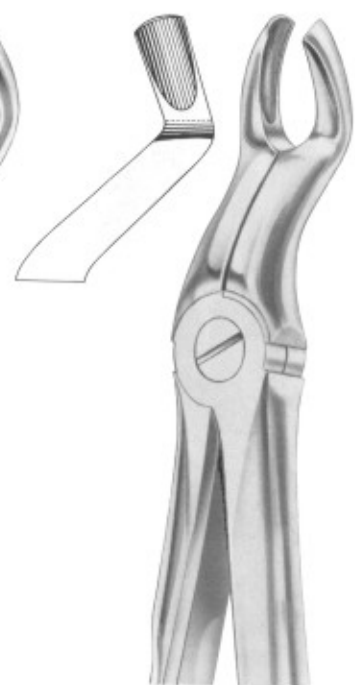

**1186**  
Fig. 67A  
upper third molars



## Extracting Forceps "With Fitting Handle"



**1187**  
Fig. 67 1/2 R  
upper third molars  
right



**1188**  
Fig. 67 1/2 L  
upper third molars  
left



**1189**  
Fig. 73  
lower molars



**1190**  
Fig. 74  
lower roots



**1191**  
Fig. 74M  
lower roots



**1192**  
Fig. 74N  
lower roots



**1193**  
Fig. 74XN  
lower roots and  
crowded incisors



## Extracting Forceps "With Fitting Handle"



**1194**  
Fig. 75  
lower premolars



**1195**  
Fig. 76  
upper roots



**1196**  
Fig. 76N  
upper roots



**1197**  
Fig. 81  
lower premolars  
and roots

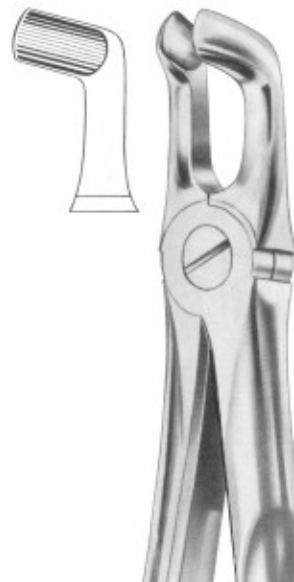

**1198**  
Fig. 76A  
lower third molars



**1199**  
Fig. 79  
lower third molars





## Extracting Forceps “With Fitting Handle”



**1200**  
Fig. 86A  
lower molars



**1201**  
Fig. 86B  
lower molars



**1202**  
Fig. 86C  
lower molars



**1203**  
Fig. 99  
lower molars



**1204**  
Fig. 99 1/4  
lower molars



**1205**  
Fig. 136  
upper premolars  
and roots



**1206**  
Fig. 143  
lower roots



## Extracting Forceps "For Children"



**1207**  
KLEIN (Fig. 217)  
upper incisors



**1208**  
KLEIN (Fig. 218)  
upper premolars



**1209**  
KLEIN (Fig. 219)  
upper roots

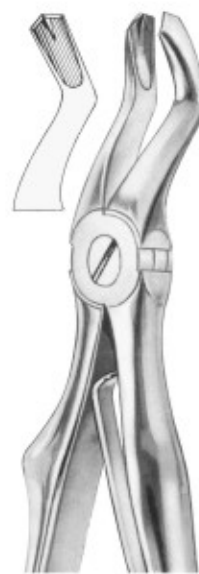

**1210**  
KLEIN (Fig. 220)  
upper molars



**1214**  
ALBRECHT  
Fig. 224  
Deciduous

**1215**  
ALBRECHT  
Fig. 225  
Deciduous



**1211**  
KLEIN (Fig. 221)  
lower incisors



**1212**  
KLEIN (Fig. 222)  
lower molars



**1213**  
KLEIN (Fig. 223)  
lower roots



## Root Splinter Forceps

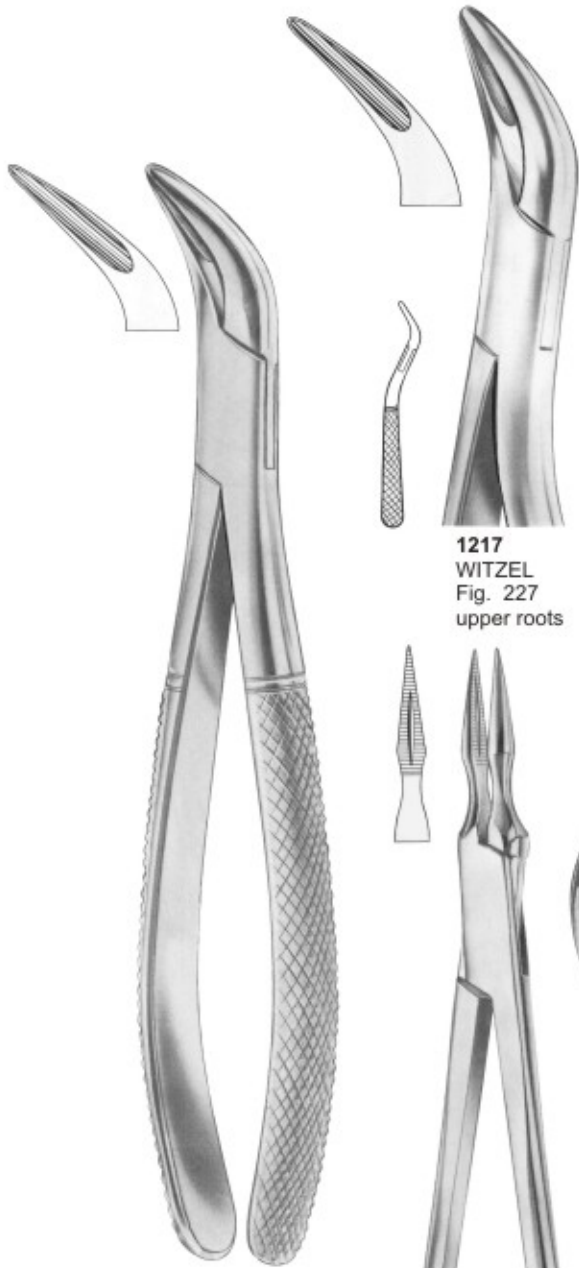

**1216**  
WITZEL  
Fig. 226  
lower roots

**1217**  
WITZEL  
Fig. 227  
upper roots



**1218**  
ARTHUR  
Fig. 228  
root fragments

**1219**  
STIEGLITZ  
Fig. 229  
root fragments

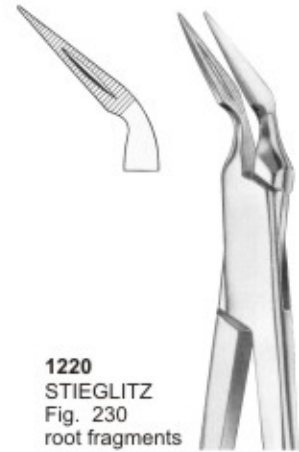

**1220**  
STIEGLITZ  
Fig. 230  
root fragments



**1221**  
RALK  
Fig. 231  
root fragments





## Extracting Forceps "American Pattern"



**1222**  
W1-WINTER  
upper centrals  
and canines



**1223**  
Fig. 1  
upper incisors and roots



**1224**  
Fig. 2  
upper and lower roots



**1225**  
Fig. 4  
upper and lower premolars



**1226**  
PHYSICK  
Fig. 5  
lower third molars



**1227**  
Fig. 6  
separating  
forceps



# Extracting Forceps "American Pattern"



**1228**  
Fig. 7  
upper roots

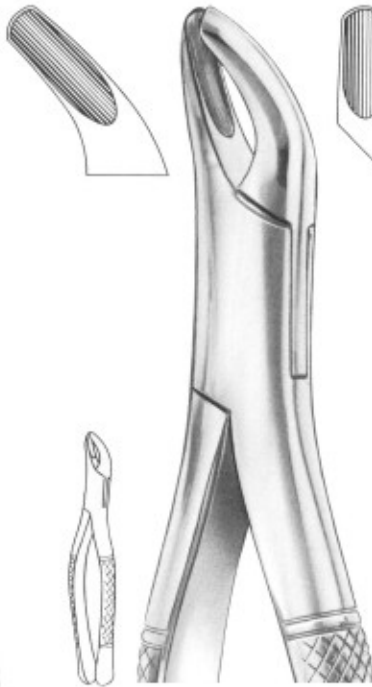

**1229**  
Fig. 8  
upper and lower  
third molars



**1231**  
Fig. 10H  
upper molars



**1232**  
Fig. 13  
upper incisors

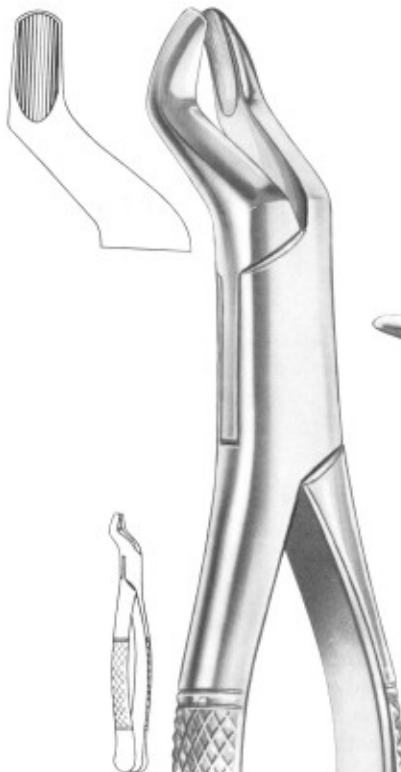

**1230**  
Fig. 10S  
upper molars



**1233**  
Fig. 14  
lower incisors





# Extracting Forceps "American Pattern"

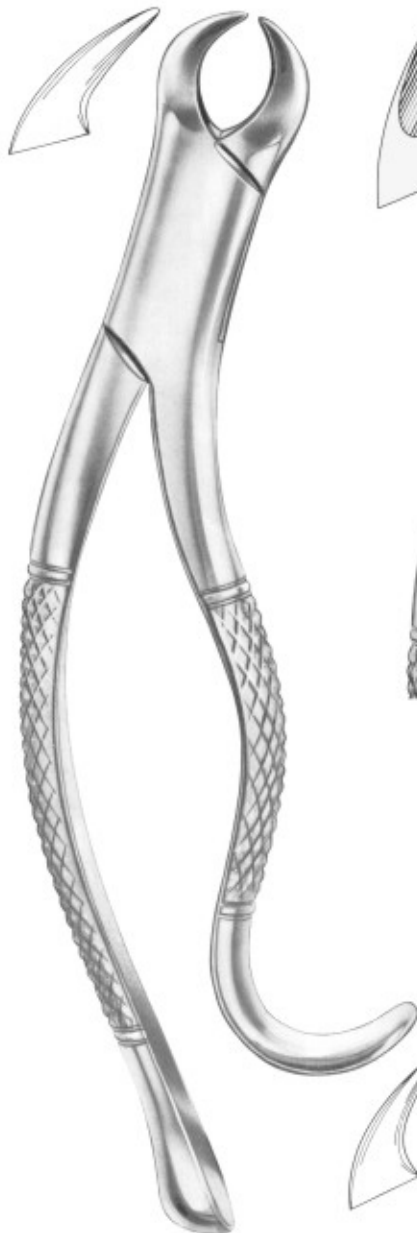

**1234**  
Fig. 16  
lower molars



**1235**  
HARRIS  
Fig. 15  
lower molars



**1237**  
HARRIS  
Fig. 18R  
upper molars right



**1238**  
HARRIS  
Fig. 18L  
upper molars left



**1236**  
Fig. 16S  
lower molars  
for children

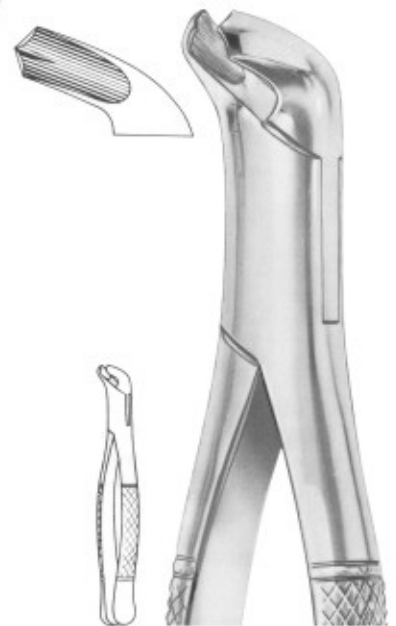

**1239**  
Fig. 17  
lower molars





# Extracting Forceps "American Pattern"



**1240**  
Fig. 20R  
upper molars right



**1241**  
Fig. 20L  
upper molars left



**1242**  
Fig. 23  
lower molars

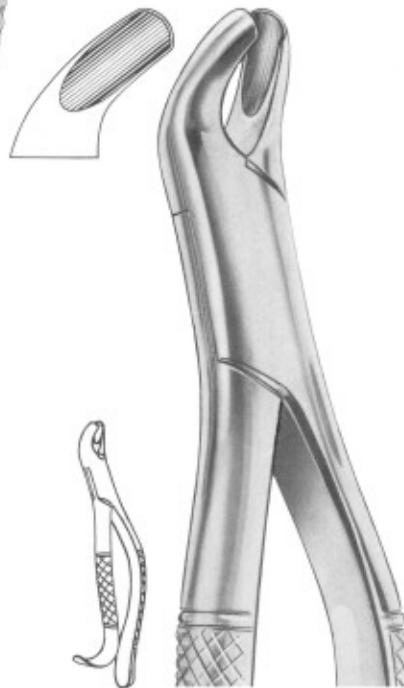

**1243**  
Fig. 24  
upper molars



**1244**  
Fig. 27  
lower molars



**1245**  
Fig. 29S  
lower teeth  
for children



# Extracting Forceps "American Pattern"



**1246**  
Fig. 30S  
upper teeth  
for children



**1247**  
PARMLY  
Fig. 32  
upper premolars  
and molars



**1248**  
PARMLY  
Fig. 32A  
upper premolars  
and roots



**1249**  
Fig. 34  
lower anteriors  
and roots

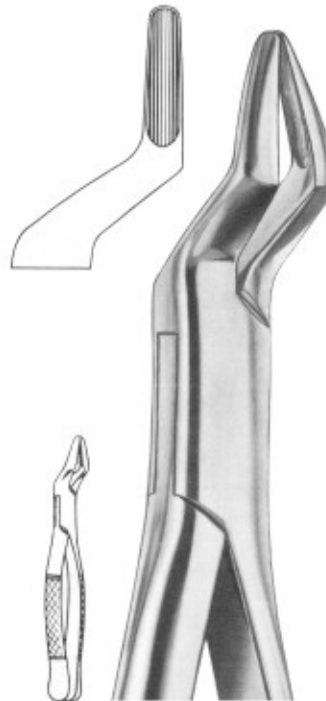

**1250**  
Fig. 35  
upper roots



**1251**  
Fig. 36  
lower anteriors  
and roots



## Extracting Forceps "American Pattern"



**1252**  
Fig. 37  
lower anteriors  
and roots

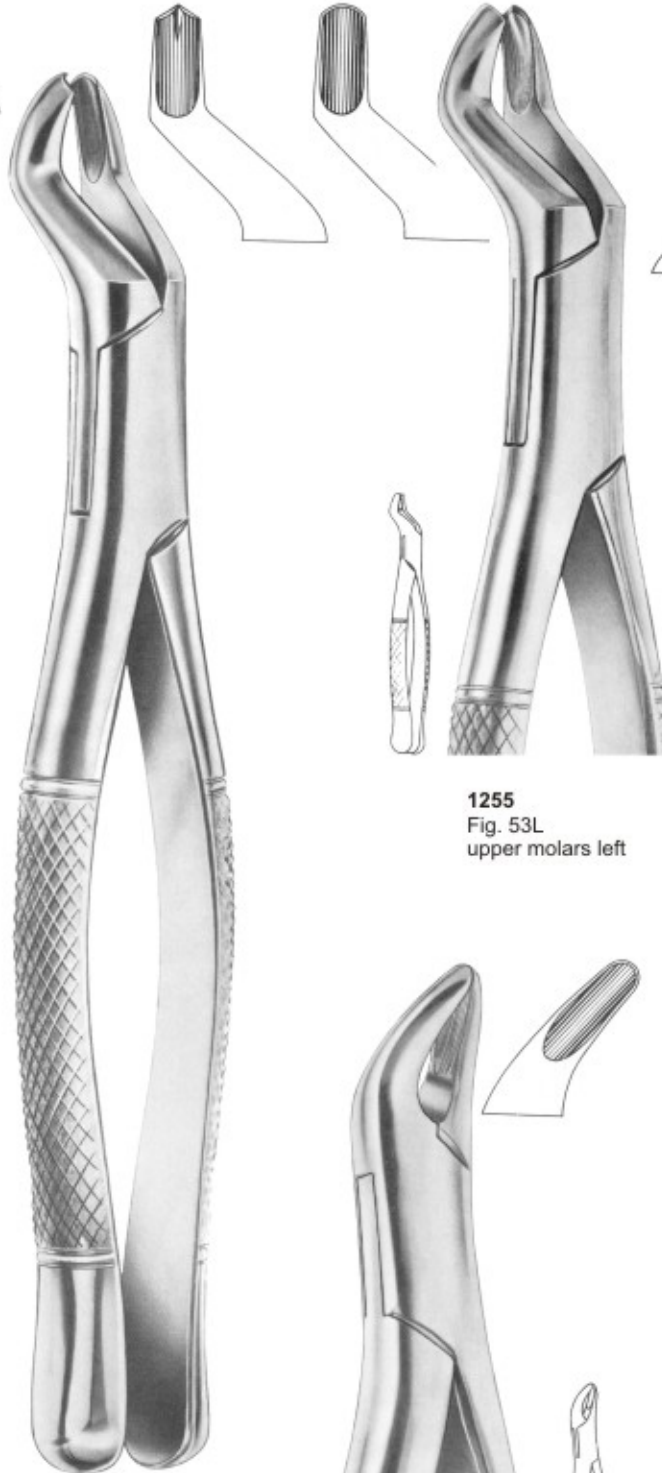

**1254**  
Fig. 53R  
upper molars right

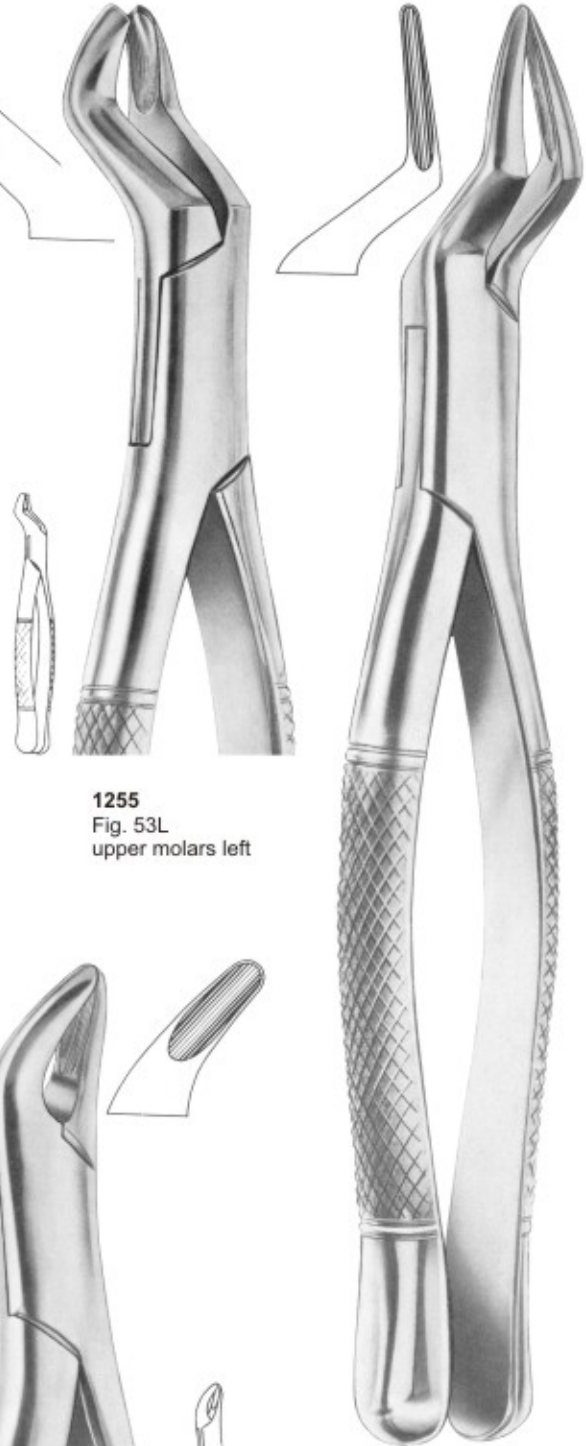

**1255**  
Fig. 53L  
upper molars left

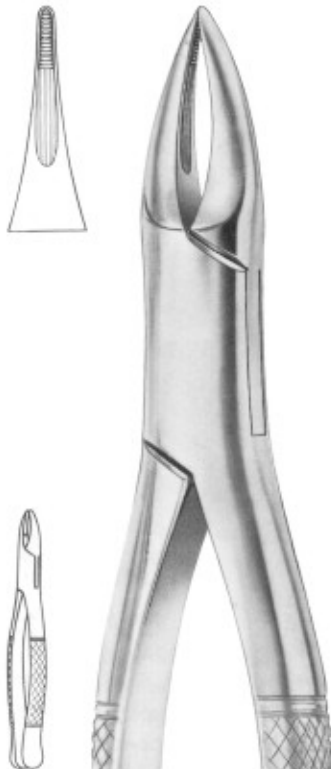

**1253**  
Fig. 38  
upper anteriors  
and roots

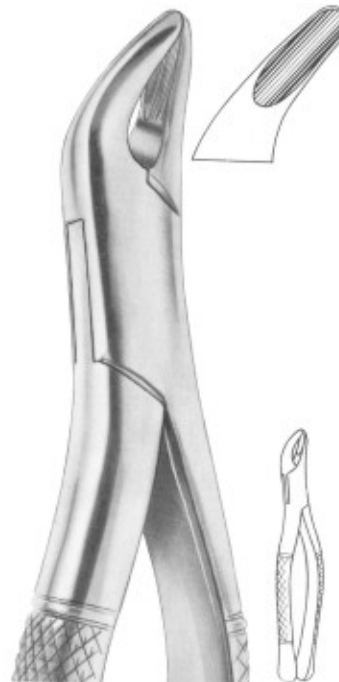

**1256**  
Fig. 62  
incisors, premolars,  
deciduous teeth

**1257**  
Fig. 65  
upper incisors  
and roots





## Extracting Forceps "American Pattern"



**1258**  
TOMEs  
Fig. 69  
upper and lower roots



**1259**  
TOMEs  
Fig. 85  
lower canines,  
premolars and molars

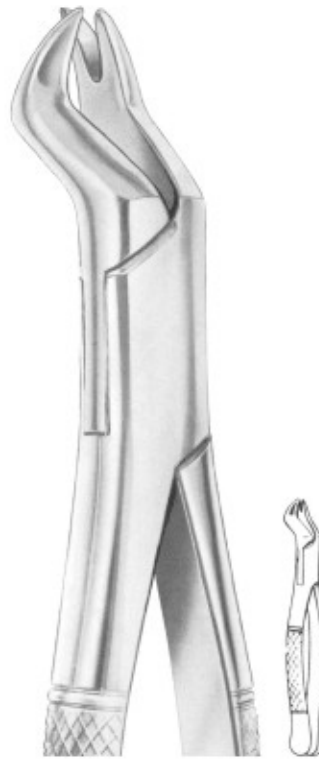

**1260**  
NEVIUS  
Fig. 88R  
upper molars right



**1261**  
THOMAS  
Fig. 85A  
lower canines,  
premolars and molars



**1262**  
NEVIUS  
Fig. 88L  
upper molars left



## Extracting Forceps "American Pattern"



**1263**  
KELLS  
Fig. 99A  
upper incisors,  
canines, premolars



**1264**  
Fig. 104  
upper third molars



**1266**  
HULL  
Fig. 101  
deciduous teeth



**1267**  
Fig. 103  
lower incisors,  
premolars



**1265**  
KELLS  
Fig. 99C  
upper incisors,  
canines, premolars





## Extracting Forceps "American Pattern"



**1268**  
CRYER  
Fig. 150  
lower incisors,  
premolars, roots



**1269**  
CRYER  
Fig. 150A  
upper incisors,  
premolars, roots

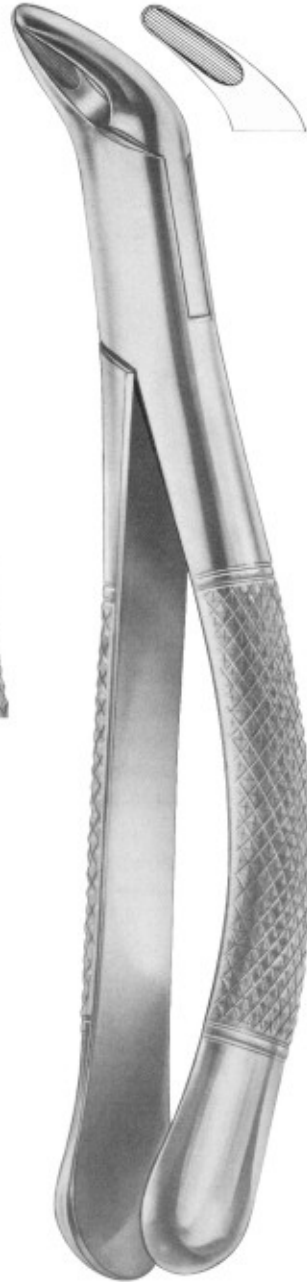

**1271**  
CRYER  
Fig. 151  
lower incisors,  
premolars, roots



**1272**  
CRYER  
Fig. 151A  
lower incisors,  
premolars, roots

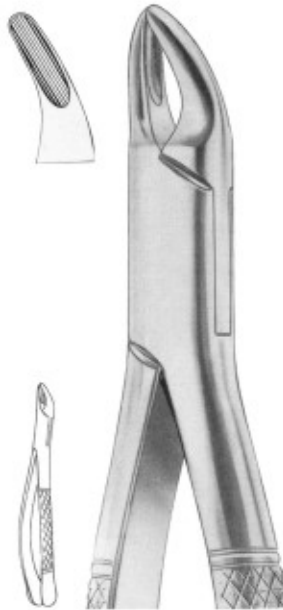

**1270**  
CRYER  
Fig. 150S  
upper teeth for children



**1273**  
CRYER  
Fig. 151S  
lower teeth  
for children





## Extracting Forceps “American Pattern”



**1274**  
Fig. 203  
lower incisors  
and roots



**1275**  
Fig. 210S  
upper third molars



**1277**  
Fig. 210H  
upper third molars



**1278**  
Fig. 213  
upper centrals and canines



**1276**  
Fig. 201  
upper incisors,  
canines, premolars

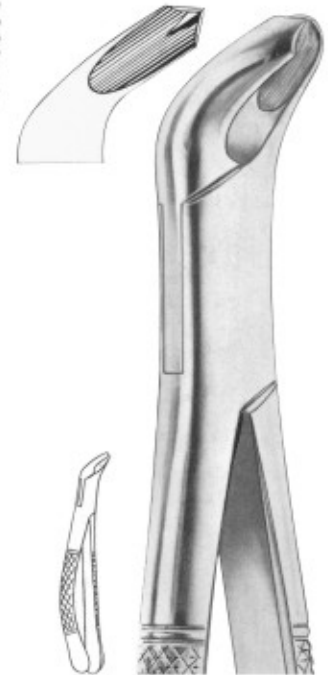

**1279**  
Fig. 217  
lower molars



## Extracting Forceps "American Pattern"

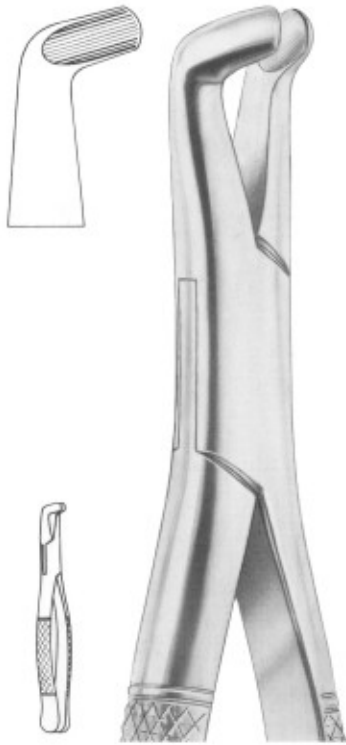

**1280**  
Fig. 222  
lower third molars



**1282**  
Fig. 286  
Swing lower molars



**1283**  
Fig. 288  
lower canines  
and premolars

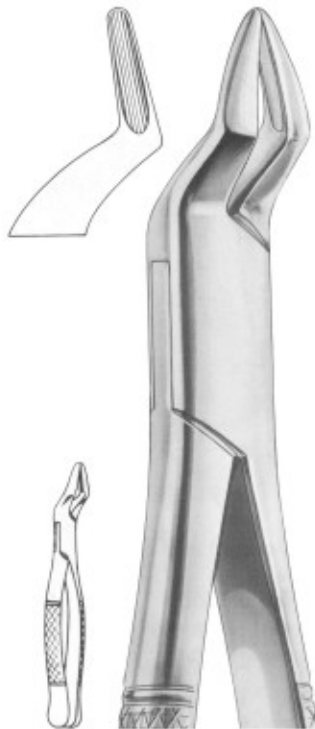

**1281**  
Fig. 286  
upper incisors and roots



## Extracting Forceps “American Pattern”



**1284**  
COHEN  
Fig. 310  
universal forceps

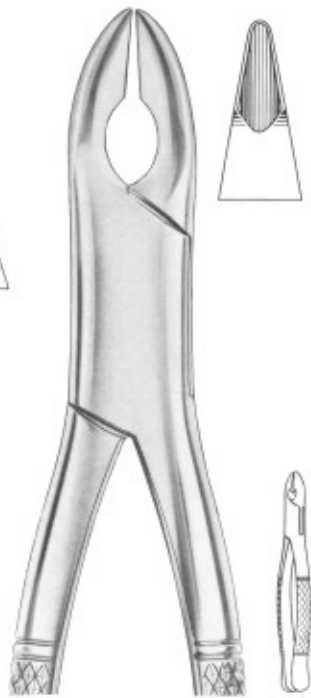

**1285**  
NEVIUS  
Fig. 320/10S  
upper canines



**1287**  
NEVIUS  
Fig. 325/10H  
upper canines



**1286**  
HENAHAN  
Fig. 315/1A  
upper incisors



**1288**  
STANDARD  
Fig. 330/4  
upper third molars





# Extracting Forceps "American Pattern"



**1289**  
WOODWARD  
Fig. 335/FH  
lower molars



**1290**  
Fig. 340/89  
upper molars right



**1292**  
Fig. 345/90  
upper molars left

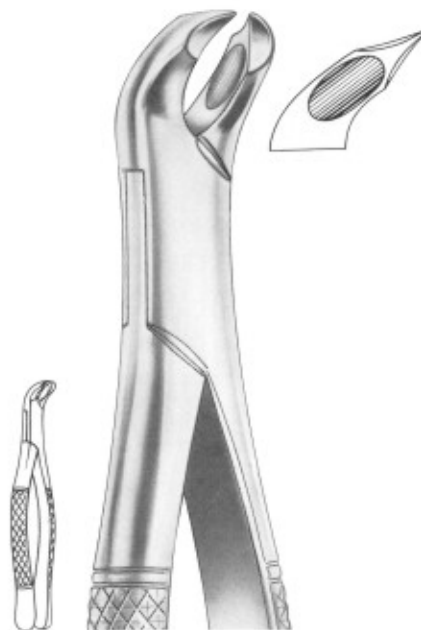

**1291**  
WOODWARD  
Fig. 335/FS  
lower molars



## Forceps For Children "American Pattern"



**1293**  
Fig. 350/23S  
lower molars



**1294**  
Fig. 355/23SK  
lower molars



**1295**  
Forcep Fig. 301



**1295-A**  
Forcep Fig. 300



**1296**  
Fig. 360/17SK  
lower molars



**1297**  
Fig. 365/150SK  
upper anteriors  
and roots



**1298**  
Fig. 370/151SK  
lower anteriors  
and roots



## Peristeel Elevators



**1299**  
Molt 9



**1300**  
Allen 9A



**1301**  
Prichard



**1302**  
Seldin



**1303**  
Goldman- Fox 14



**1304**  
West  
Dell W2





# Elevators

## Heidbrink Root - Tip Picks

### Root Tip



1305  
DEL 78



1306  
DEL 79



1307  
DEL 80

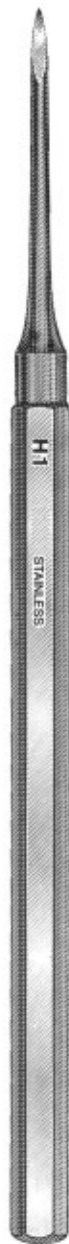

1308  
DEL H1



1309  
DEL H2



1310  
DEL H3



1311  
DEL H2-3



1312  
POTT  
6X

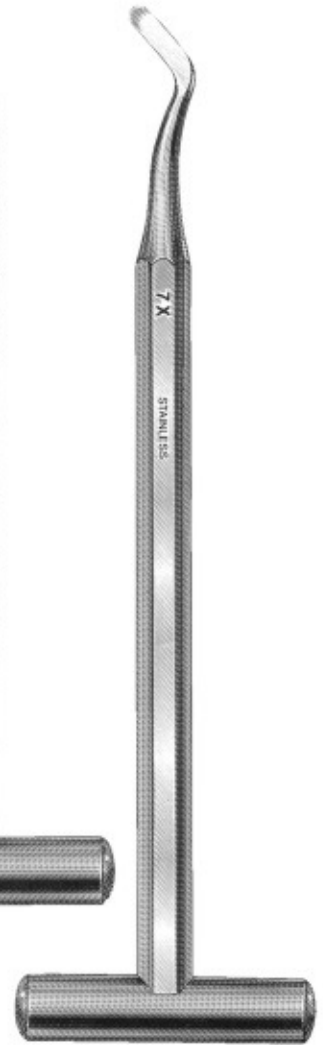

1313  
POTT  
7X



## Periosteal Elevators



**1314**  
BUSER



**1315**  
OHI 10



**1316**  
HOWARD 9H



**1317**  
FREER



**1318**  
FREER 15



**1319**  
FREER 16



# Root Elevators



lower jaw, left side

lower jaw, right side



**1320**  
BEIN  
Fig. 4



**1331**



**1332**

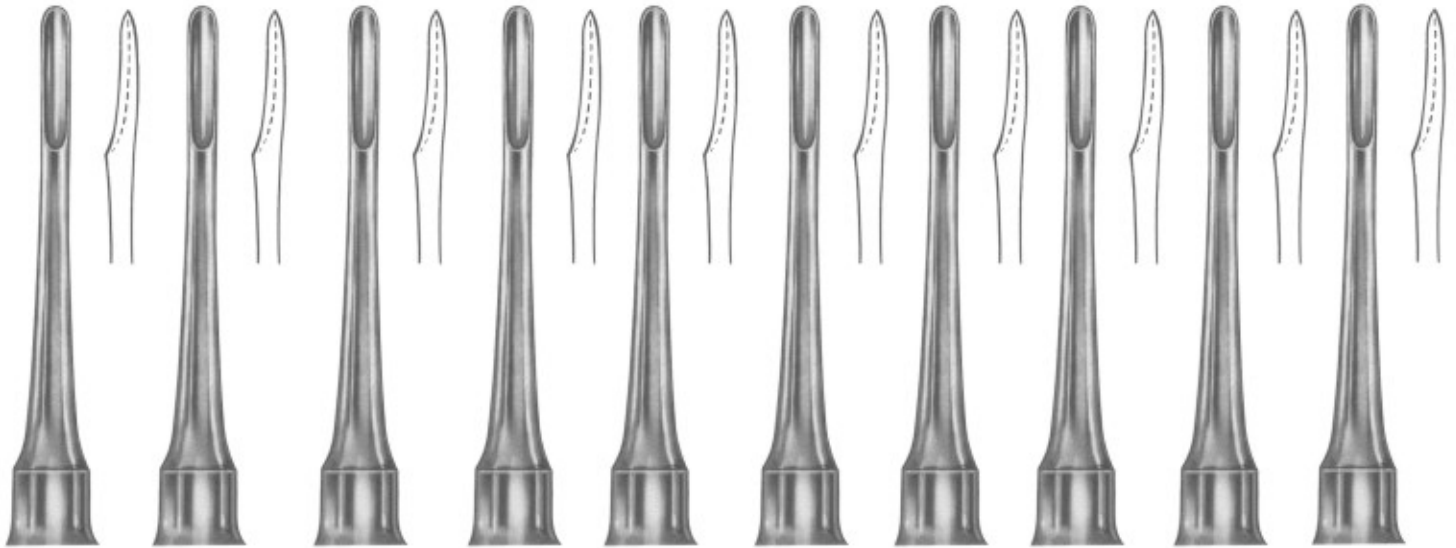

**1321**  
BEIN  
1.0 mm

**1322**  
BEIN  
1.5 mm

**1323**  
BEIN  
2.0 mm

**1324**  
BEIN  
2.5 mm

**1325**  
BEIN  
3.0 mm

**1326**  
BEIN  
3.5 mm

**1327**  
BEIN  
4.0 mm

**1328**  
BEIN  
4.5 mm

**1329**  
BEIN  
5.0 mm

**1330**  
BEIN  
5.5 mm





# Root Elevators

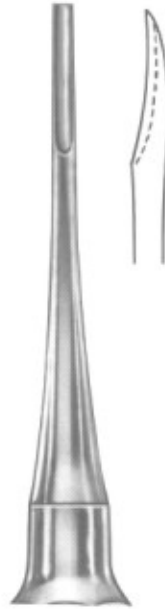

1334  
BEIN  
Fig. 1



1335  
BEIN  
Fig. 2



1336  
BEIN  
Fig. 0



1337  
BEIN  
Fig. 3



1333  
BEIN

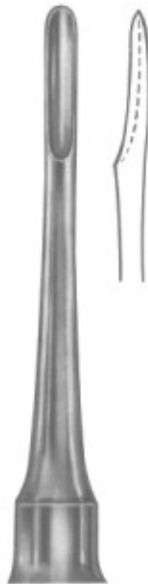

1338  
BEIN  
Fig. 4



1339  
BEIN  
Fig. 5



1340  
BEIN  
Fig. 6



# Root Elevators



**1341**  
CRYER  
Fig. 3



**1342**  
CRYER  
Fig. 4



**1343**  
CRYER  
Fig. 12



**1344**  
CRYER  
Fig. 27



**1345**  
CRYER  
Fig. 28



**1346**  
CRYER  
Fig. 27S



**1347**  
CRYER  
Fig. 28S



**1348**  
SELDIN  
Fig. 2



**1349**  
SELDIN  
Fig. 3



**1350**  
SELDIN  
Fig. 4L



**1351**  
SELDIN  
Fig. 4R



**1352**  
SELDIN  
Fig. 1L



**1353**  
SELDIN  
Fig. 1R



## Swa Elevators & Root Screws



1354



1355



1356



1357



1358



1359



1360

## Root Screws



1362  
Morrison  
2.0 mm



1363  
Morrison  
2.5 mm



1364  
Morrison  
3.0 mm



1361  
Morrison  
3.5 mm





# Root Elevators



**1365**  
IS-APICAL



**1366**  
APICAL  
2 mm  
Fig. 1



**1367**  
APICAL  
3 mm  
Fig. 2



**1368**  
APICAL  
4 mm  
Fig. 3



**1369**  
APICAL  
4.5 mm  
Fig. 4



**1370**  
APICAL  
2 mm  
Fig. 5



**1371**  
APICAL  
3 mm  
Fig. 6



**1372**  
APICAL  
4 mm  
Fig. 7



**1373**  
APICAL  
4.5 mm  
Fig. 8



**1374**  
APICAL  
Fig. 9



**1375**  
WINTER  
Fig. 14 L



**1376**  
WINTER  
Fig. 14 R



**1377**  
HEIDBRINK  
Fig. 1



**1378**  
HEIDBRINK  
Fig. 2



**1379**  
FLOHR  
Fig. 1



**1380**  
FLOHR  
Fig. 2



**1381**  
APICAL  
Fig. 1



**1382**  
APICAL  
Fig. 2



## Root Elevators



**1383**  
IS-CRYER



**1384**  
CRYER  
Fig. 1



**1385**  
CRYER  
Fig. 2



**1386**  
IS-COUPLAND



**1387**  
COUPLAND  
Fig. 1



**1388**  
COUPLAND  
Fig. 2



**1389**  
COUPLAND  
Fig. 3



## Root Elevators



**1390**  
Fig. 1



**1391**  
Fig. 2



**1392**  
Fig. 3



**1393**  
FLOHR  
Fig. 1



**1394**  
FLOHR  
Fig. 2



**1395**  
FLOHR  
Fig. 3





# Root Elevators



1396  
KOPP  
Fig. 1



1397  
KOPP  
Fig. 2



1403  
KOPP  
Fig. 1



1404  
KOPP  
Fig. 2



1396  
KOPP



1398  
KOPP  
Fig. 3



1399  
KOPP  
Fig. 4



1402  
KOPP



1405  
KOPP  
Fig. 3



1406  
KOPP  
Fig. 4



1400  
KOPP  
Fig. 5



1401  
KOPP  
Fig. 6



# Root Elevators



1407  
HYLIN



1407  
HYLIN  
Fig. 1



1408  
HYLIN  
Fig. 2



1409  
BEIN

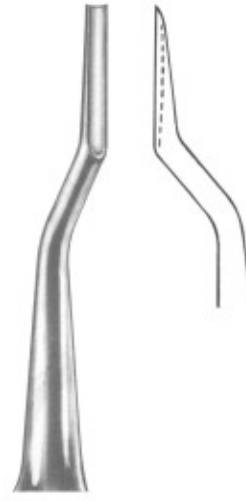

1409  
BEIN  
Fig. 1

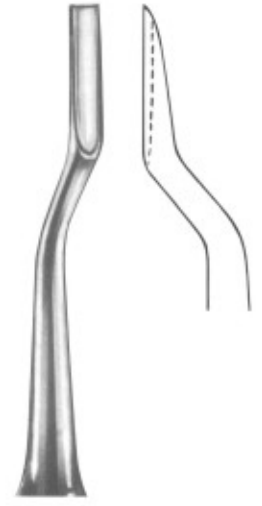

1410  
BEIN  
Fig. 2



1411  
BEIN  
Fig. 3

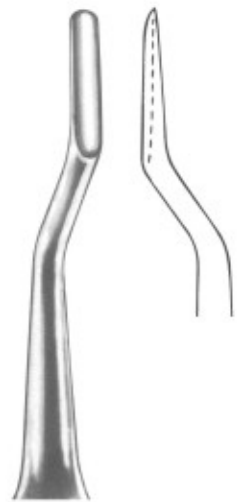

1412  
BEIN  
Fig. 4



## Root Elevators



**1413**  
WARWICK-JAMES  
Fig. 1



**1413**  
Warwick-James  
Fig. 2



**1414**  
Warwick-James  
Fig. 3



**1415**  
London-Hospital  
Fig. 1



**1415**  
London-Hospital  
Fig. 2



**1416**  
London-Hospital  
Fig. 3



**1417**  
OTT





## Root Elevators



**1418**  
CHOMPRET  
Fig. 1



**1419**  
CHOMPRET  
Fig. 2



**1420**  
CHOMPRET  
Fig. 3



**1421**  
CHOMPRET  
Fig. 4



**1423**  
Fig. 1



**1422**  
Fig. 2

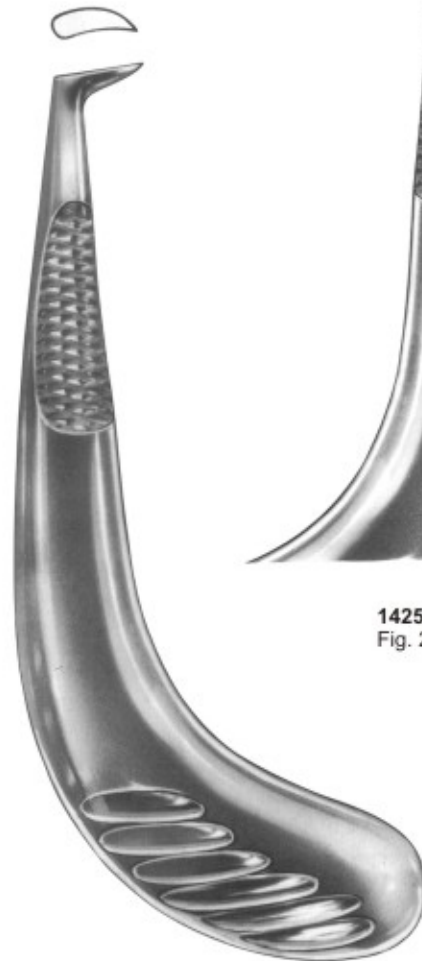

**1424**  
Fig. 1



**1425**  
Fig. 2



**1426**  
APICAL



## Root Tip Elevators



**1427**  
IS-Fig. 1



**1428**  
Fig. 2



**1429**  
Fig. 3



**1430**  
HEIDBRINK  
Fig. 1



**1431**  
HEIDBRINK  
Fig. 2



**1432**  
HEIDBRINK  
Fig. 3



**1438**  
MEAD  
MD1



**1433**  
LECLUSE



**1434**  
MEAD  
MD-5 A



**1435**  
MEAD  
MD-6 A



**1436**  
MEAD  
MD-7 A



**1437**  
MEAD  
MD-8



# Root Elevators



**1439**  
WINTER  
Fig. 1L



**1440**  
WINTER  
Fig. 1R



**1441**  
WINTER  
Fig. 2L



**1442**  
WINTER  
Fig. 2R

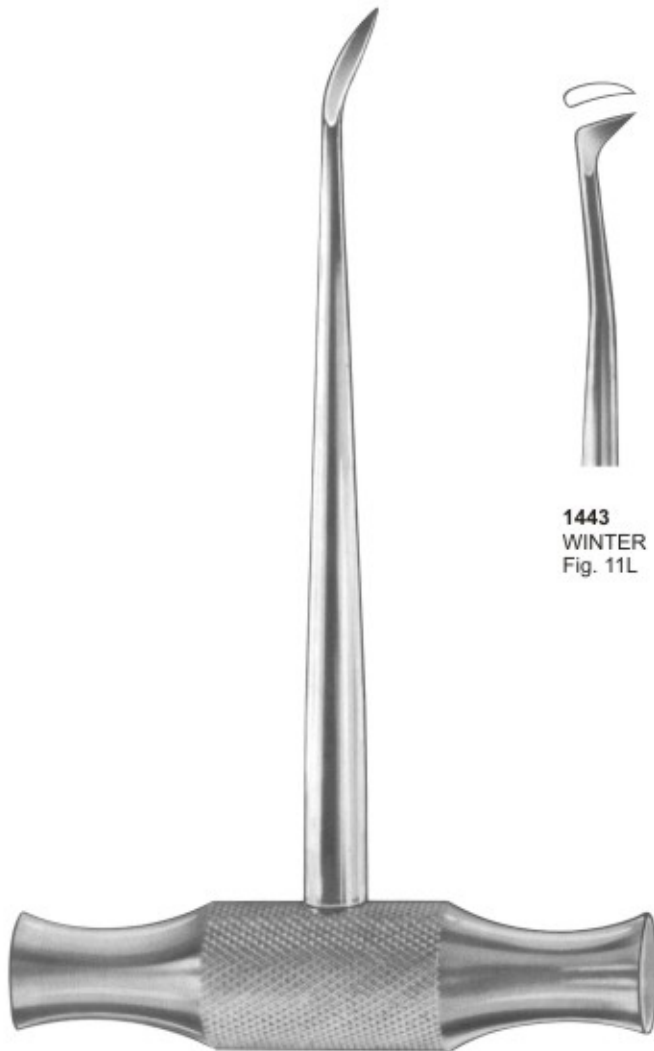

**1439**  
WINTER



**1443**  
WINTER  
Fig. 11L



**1444**  
WINTER  
Fig. 11R



**1445**  
WINTER  
Fig. 12L



**1446**  
WINTER  
Fig. 12R



**1447**  
WINTER  
Fig. 14L



**1448**  
WINTER  
Fig. 14R





# Root Elevators



**1449**  
BARRY  
Fig. 1



**1450**  
BARRY  
Fig. 2



**1451**  
BARRY  
Fig. 3



**1452**  
BARRY  
Fig. 4



**1449**  
BARRY



**1453**  
BARRY  
Fig. 11



**1454**  
BARRY  
Fig. 12



**1455**  
BARRY  
Fig. 17



**1456**  
BARRY  
Fig. 18



## Root Elevators



**1458**  
CRYER  
Fig. 26



**1459**  
SELDIN  
Fig. 27



**1460**  
CRYER  
Fig. 28



**1461**  
CRYER  
Fig. 29



**1462**  
HEIDBRINK  
Fig. 22



**1463**  
HEIDBRINK  
Fig. 23



**1457**



## Root Elevators



**1465**  
KOPP  
Fig. 31



**1466**  
KOPP  
Fig. 32



**1467**  
KOPP  
Fig. 33



**1468**  
KOPP  
Fig. 34



**1469**  
KOPP  
Fig. 35



**1470**  
KOPP  
Fig. 44



**1464**





# Root Elevators



1472  
HEIDBRINK  
Fig. 10



1473  
WINTER  
Fig. 11



1474  
WINTER  
Fig. 12



1475  
BARRY  
Fig. 17



1476  
BARRY  
Fig. 18



1477  
BARRY  
Fig. 20



1471

Root Elevators according to Dr. Sader,  
with interchangeable working tips

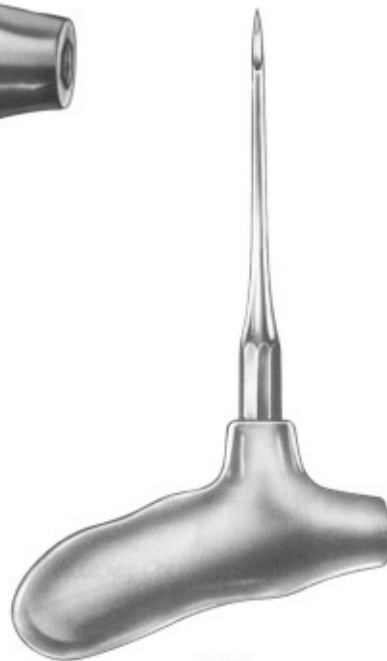

1478



1479



1480



## Elevators Plastic Handle

1481

Root Elevator, Plastic Handle, Set of 10 Pcs

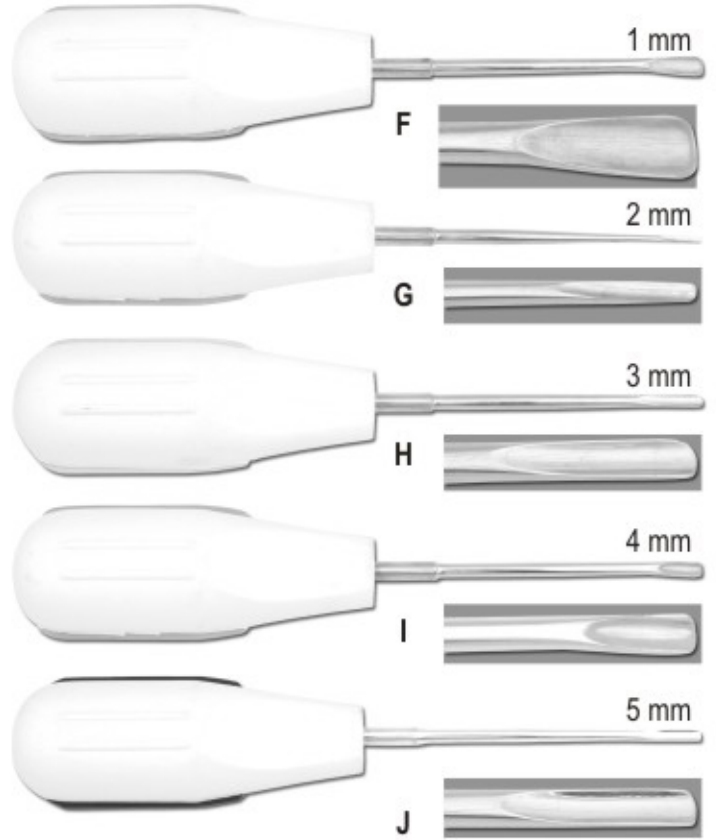
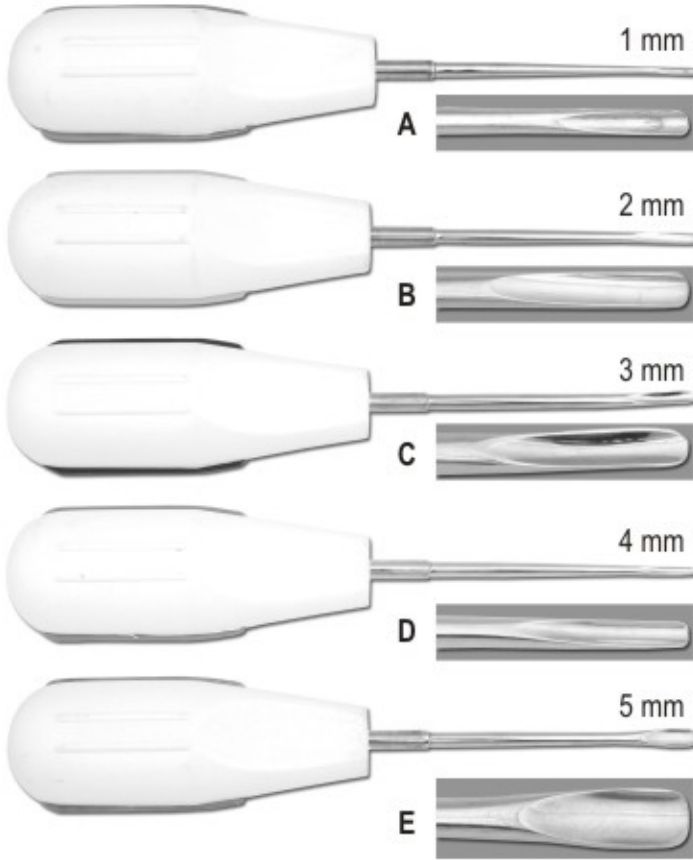

1482

Root Elevator, Plastic Handle, Set of 5 Pcs

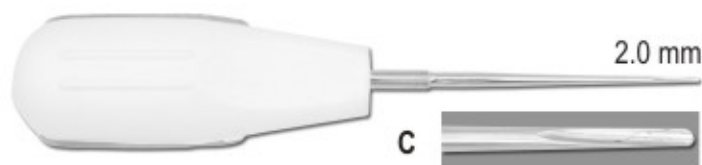
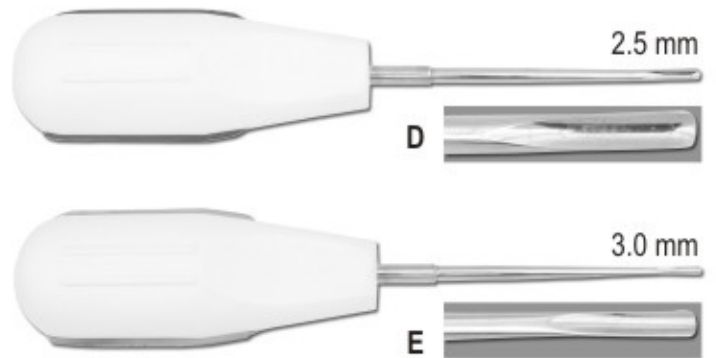
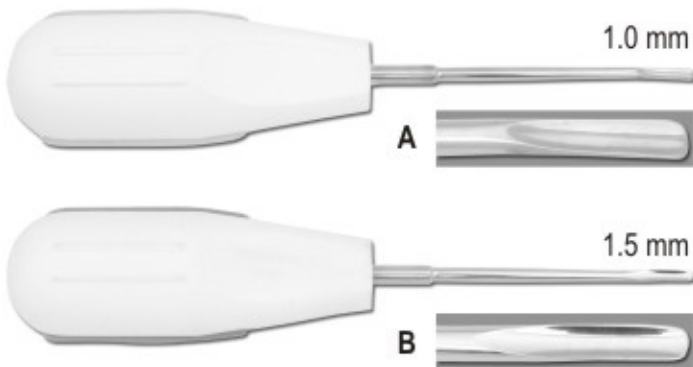



## Scalpel Handles



**1483**

Scalpel Handle Angle Of Blade Adjusts To Easily Get Around Corners  
Adjustment Sets Blade From Straight To Back Angled  
Locks In At 90°, 60°, 30°, Straight, -30°, -60° Angles



**1484**

Scalpel Handle  
Fig. 5



**1485**

Scalpel Handle  
Curved



**1486**  
Fig. 3L



**1487**  
Fig. 7



**1488**  
Scalpel Handle  
Fig. 4L, Curved  
20 cm



**1489**  
Fig. 3



**1490**  
Fig. 3G



**1491**  
Fig. 4



**1492**



**1493**  
Scalpel Handle  
4 D 14.0 cm



**1494**  
Mess Holders



**1495**  
Gouge  
Blade Handle  
Fig. 2 / 11.5 cm





## Handles

Handle For Mouth Mirrors, Probes, Explorers, Excavators, Carvers, Curettes & Scalars

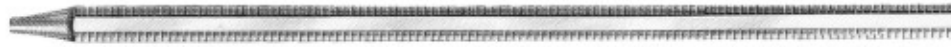

**1496**

Handle No. 2 Standard Single Ended



**1497**

Handle Single Ended



**1498**

Handle Single Ended

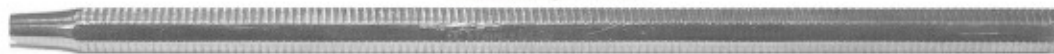

**1499**

Handle Single Ended



**1500**

Octagonal Double Ended



**1501**

Octagonal Double Ended



**1502**

Octagonal Double Ended



**1503**

Handle No. 2 (Standard Double Ended)



**1504**

Octagonal Double Ended



**1505**

Tactile Tone Double Ended



**1506**

Tactile Tone Double Ended



**1507**

Tactile Tone Double Ended



**1508**

Handle, Double Ended



**1509**

Double Ended



**1510**

Tactile Tone Double Ended



**1511**

Tactile Tone Double Ended



# Handles & Mouth Mirrors



## Mouth Mirrors

### Plane



**1514**  
Fig. 6  
Ø 26 mm



**1515**  
Fig. 5  
Ø 24 mm



**1516**  
Fig. 4  
Ø 22 mm

### Magnifying



**1517**  
Fig. 6  
Ø 26 mm



**1518**  
Fig. 5  
Ø 24 mm



**1519**  
Fig. 4  
Ø 22 mm

### Front surface



**1520**  
Fig. 6  
Rhodium  
Ø 26 mm  
Front surface



**1521**  
Fig. 5  
Rhodium  
Ø 24 mm  
Front surface



**1522**  
Fig. 4  
Rhodium  
Ø 22 mm  
Front surface

### Plane



**1523**  
Fig. 6  
Ø 26 mm

**1524**  
Fig. 5  
Ø 24 mm

**1525**  
Fig. 4  
Ø 22 mm

### Magnifying



**1526**  
Fig. 6  
Ø 26 mm

**1527**  
Fig. 5  
Ø 24 mm

**1528**  
Fig. 4  
Ø 22 mm

With cone - socket



1513-A

### Mouth Mirrors, Magnifying 1513-A Plain 1512-B

Fig. 00	Ø	8 mm
Fig. 0	Ø	10 mm
Fig. 1	Ø	14 mm
Fig. 2	Ø	16 mm
Fig. 3	Ø	18 mm
Fig. 4	Ø	20 mm
Fig. 5	Ø	22 mm
Fig. 6	Ø	24 mm
Fig. 7	Ø	26 mm
Fig. 8	Ø	28 mm
Fig. 9	Ø	30 mm
Fig. 10	Ø	32 mm



**1512**  
Hollow Handle  
Fig. 1



**1513**  
Hollow Handle  
Fig. 2



# Mirror Handle, Mouth Mirrors



1529



1530



1531



1532



1533



1534



1535  
Parallelometer  
mouth mirror

1536  
Parallelometer  
mouth mirror  
+ handle  
code 2101



1537  
Tactile Tone  
Single Ended



1538  
Handle  
Thompson  
Single Ended



1539  
Hollow Handle



1540  
Hollow Handle  
Stainless  
Steel



1541  
Cone-socket  
Hollow Handle



1542  
Hollow Handle



1543  
Hollow Handle





# Scalers



## SCALERS - JAQUETTE

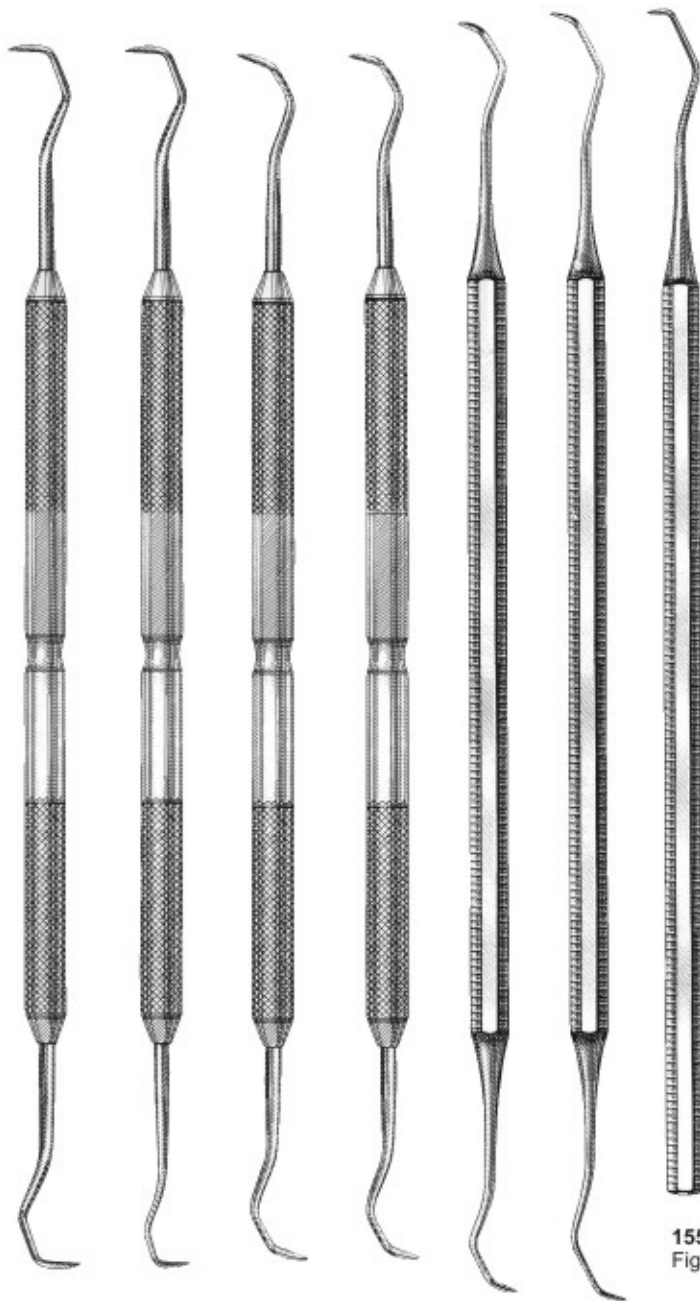

1550  
Fig.1

- 1544 1Y-1Y
- 1545 1Y-1YS
- 1546 2Y-3Y
- 1547 2YS-3YS
- 1548 2-3
- 1549 2S-3S

## SCALERS - OCTAGONAL

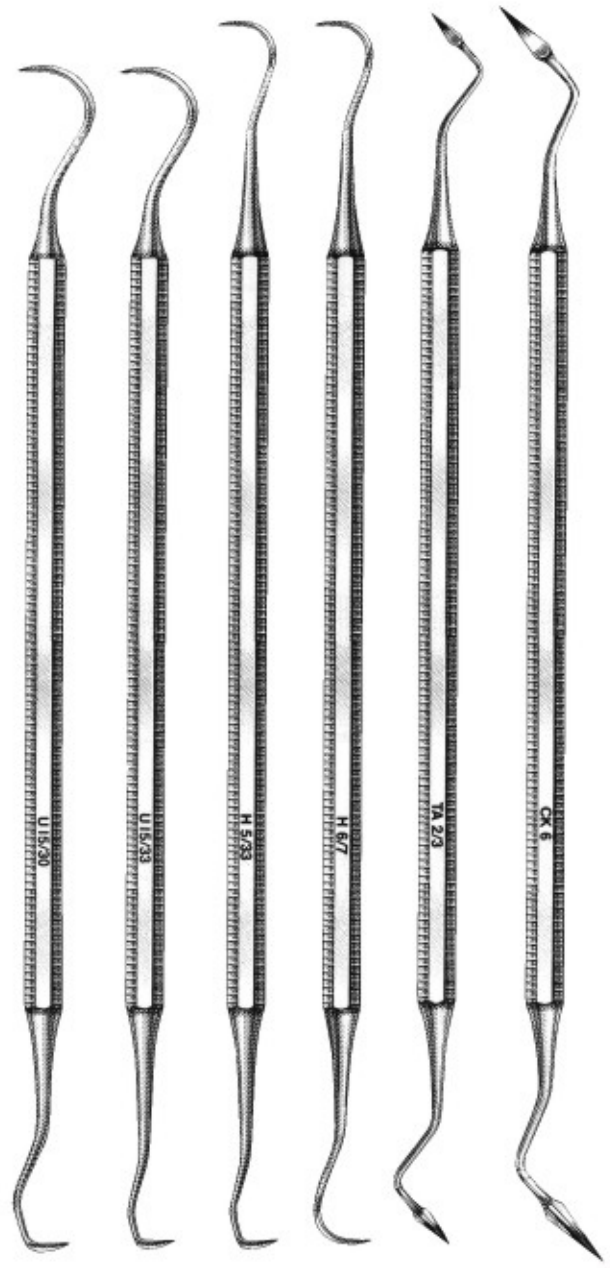

- 1551 U15-30
- 1552 U15-33
- 1553 H5-33
- 1554 H6-7
- 1555 Taylor 2-3
- 1556 CK6



## Scalers



1557  
U15



1558  
No. 3



1559  
No. 12



1560  
WHITESIDE 1-0

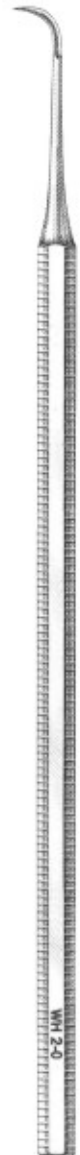

1561  
WHITESIDE 2-0



## Scalers



**1562**  
YAOUNGER/GOOD  
7-8

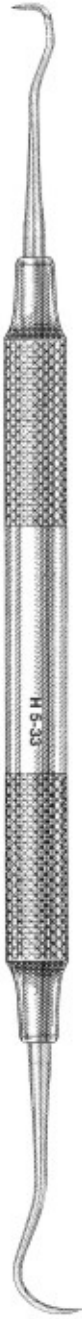

**1563**  
H5-33



**1564**  
204SD



**1565**  
H6-7

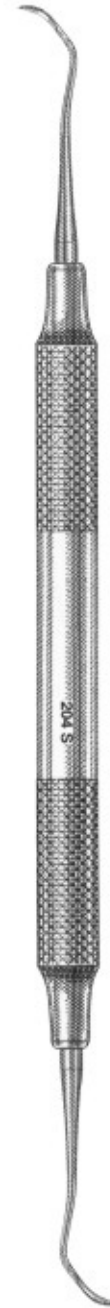

**1566**  
204S



**1567**  
TOWNER/JAQUETTE  
U15-30





# Scalers



**1568**  
JAQUETTE (33-U15)



**1569**  
JAQUETTE  
2Y-3Y



**1570**  
JAQUETTE  
30-U15



**1571**  
JAQUETTE  
2YS-3YS



**1572**  
JAQUETTE  
33-H5



**1573**  
YOUNGER/GOOD  
7-8

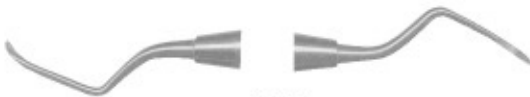

**1574**  
204S



**1575**  
204SD



**1576**  
H6-7

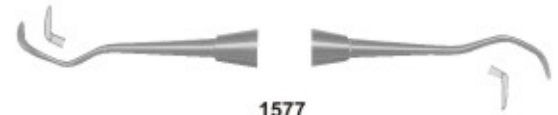

**1577**  
JAQUETTE  
2S-3S



**1578**  
JAQUETTE  
1Y-1YS



**1579**  
JAQUETTE  
2-3



# Scalers



**1580**  
JAQUETTE (33-U15)



**1581**  
S204



**1583**  
S204S



**1585**  
S204SD



**1587**  
Goldman 6-7



**1589**  
Goldman Fox 21



**1591**  
H5-U15



**1593**  
Jaquette 34-35

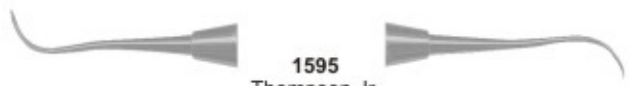

**1595**  
Thompson Jr.



**1597**  
UT107-108



**1599**  
UP128



**1582**  
Jack-Nebraska



**1584**  
Jaquette 1-U15



**1586**  
Jaquette 2-3



**1588**  
Jaquette 2S-3S



**1590**  
Jaquette 30-U15



**1592**  
Jaquette 30-33



**1594**  
Jaquette 31-32



**1596**  
Jaquette 33-H5



**1598**  
U 6-7



**1600**  
128L



# Explorers

## Explorers Double Ended - Octagonal

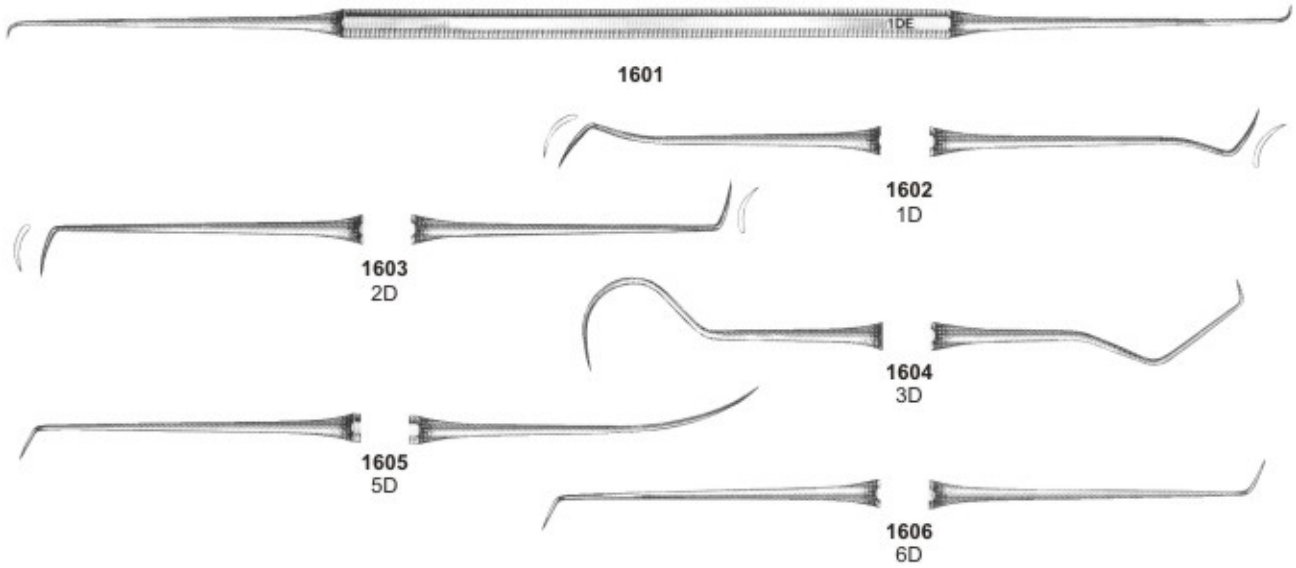

## Explorers Double Ended - Standard

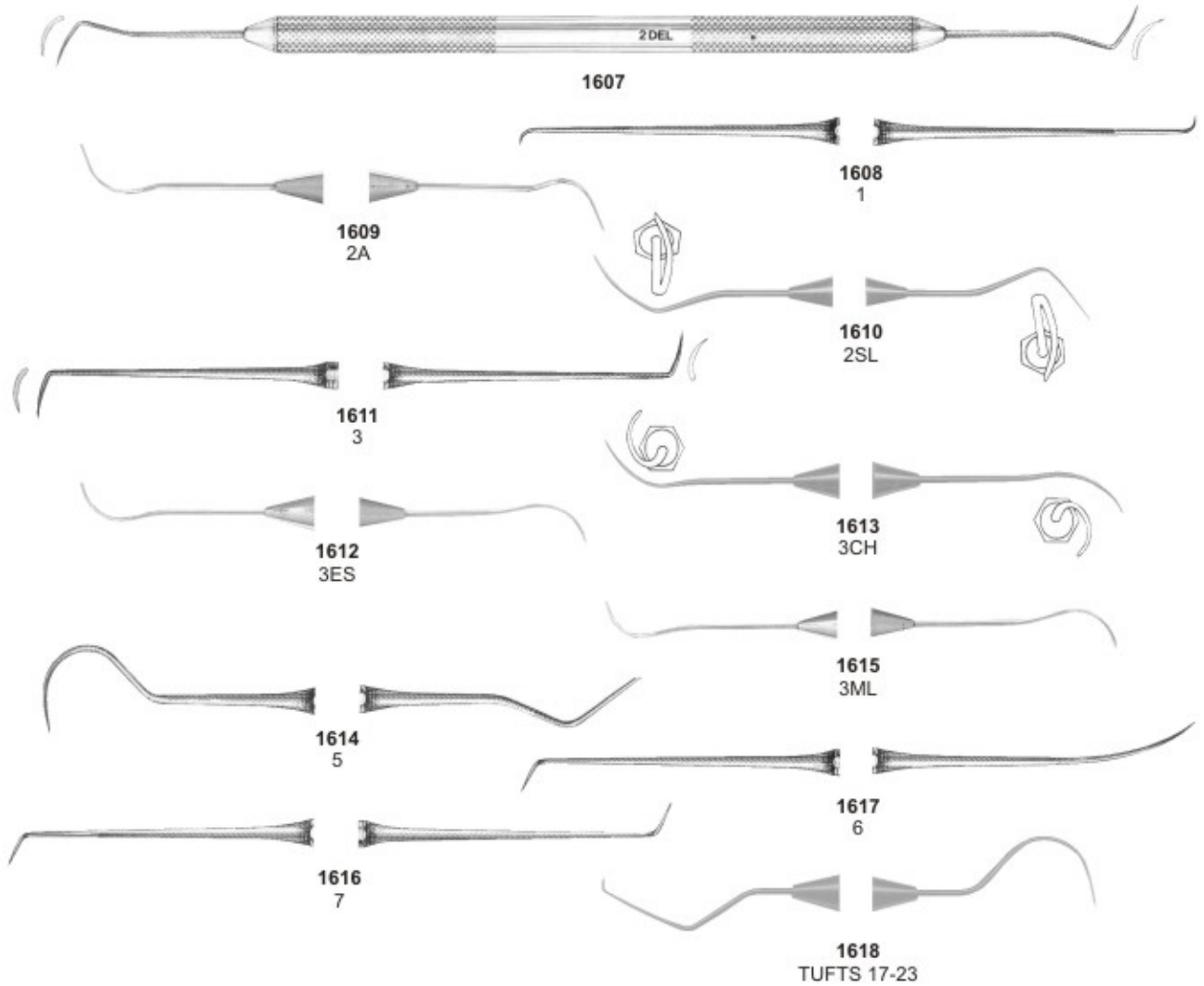





# Explorers



## Explorers Double Ended Tactile Tone



1619  
2A



1620  
2



1621  
1



1622  
2SL



1623  
3



1624  
3CH



1625  
3ES



1626  
3ML

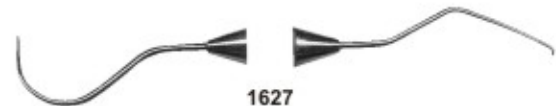

1627  
5



1628  
6



1629  
7

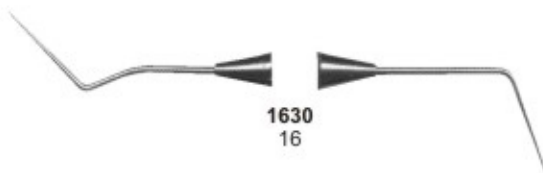

1630  
16



1631  
TUFTS 17/23



# Explorers & Probes



## Explorers Single Ended - Octagonal

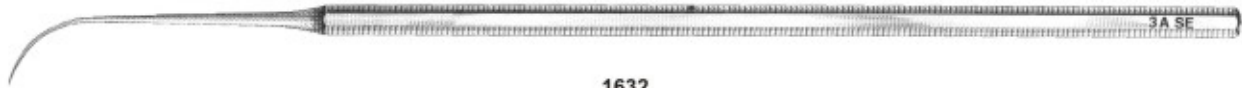

1632  
Fig. 3A



1633  
Fig. 6



1634  
Fig. 7



1635  
Fig. 17



1636  
Fig. 23

## Explorers Single Ended - Standard

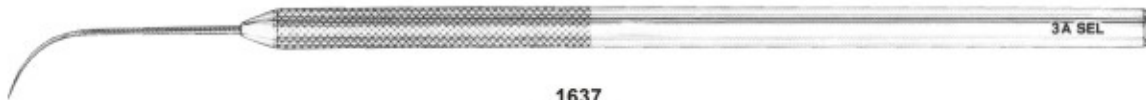

1637  
Fig. 3A



1638  
Fig. 6



1639  
Fig. 7



1640  
Fig. 17



1641  
Fig. 23

## Probe / Explorer - Octagonal



1642  
GF-17

## Double Ended Probe - Octagonal



1643  
GF-18 (1-2)



# Probes



## Probes Double Ended - Standard

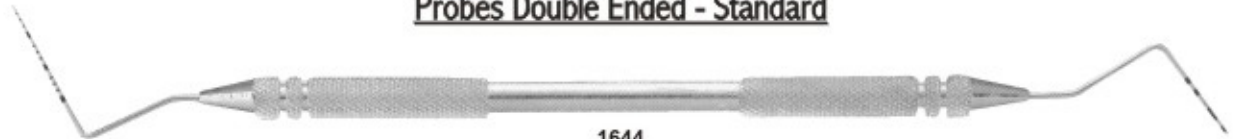

1644  
1UNC15



1645  
4UNC15



1646  
Baylor 1-2

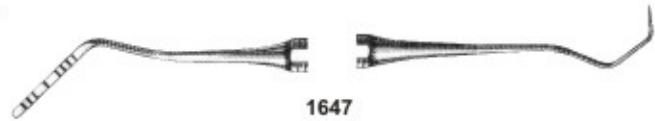

1647  
Gf17



1648  
GF18 (1-2)

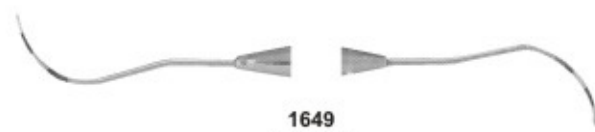

1649  
Nabor 2

## Probes Double Ended - Tactile Tone

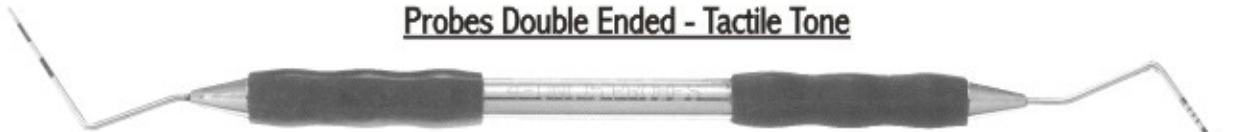

1650  
4UNC15



1651  
1UNC15



1652  
Baylor 1-2



1653  
GF18 1-2(Probe 2 end is flat)



1654  
Nabor 2





# Probes

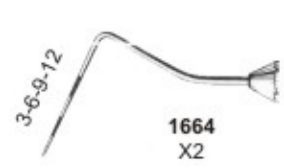
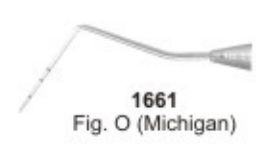
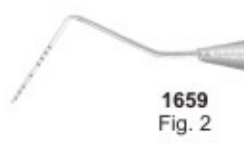
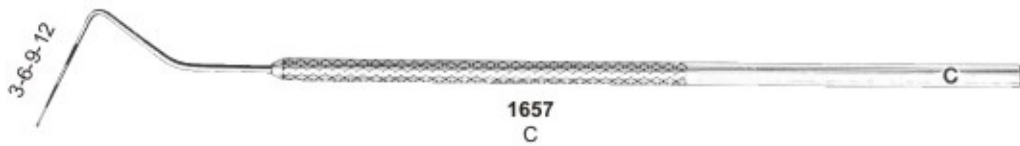
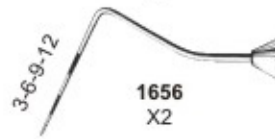
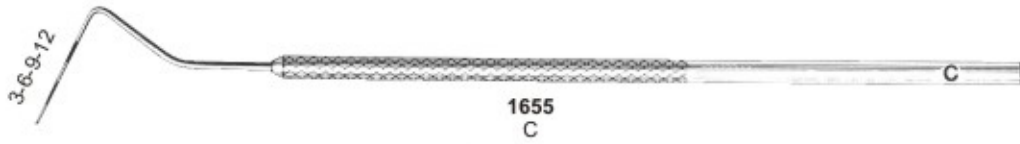



# Probes



## PROBES DOUBLE ENDED STANDARD



1672  
0-23

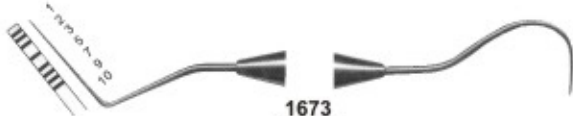

1673  
0W23



1676  
4-23



1674  
PE1-23(1-23)



1677  
UNC15-23



1675  
WHO23

## PROBES DOUBLE ENDED TACTILE TONE



1678  
0-23

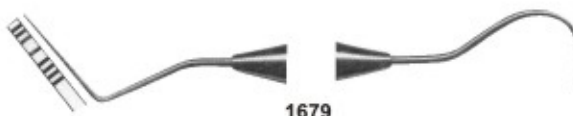

1679  
0W23

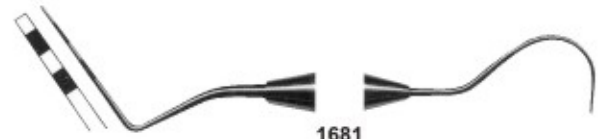

1681  
4-23



1680  
PE1-23(1-23)



1682  
UNC15-23

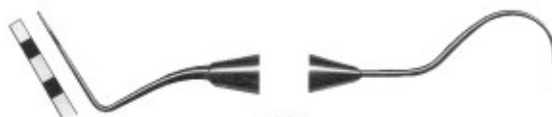

1683  
WHO23



# Endodontic Condensers



**1684**  
TF13 Root Canal 1-3

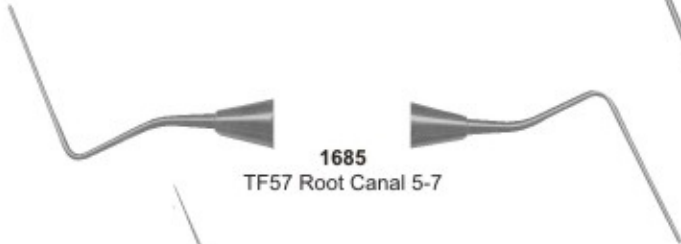

**1685**  
TF57 Root Canal 5-7

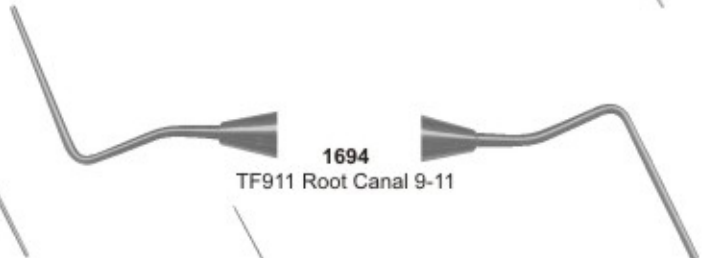

**1694**  
TF911 Root Canal 9-11



**1686**  
UF30 \*ISO-30



**1695**  
UF35 \*ISO-35



**1687**  
UF40 \*ISO-40 (8)



**1696**  
UF45 \*ISO-45



**1688**  
UF50 \*ISO-50 (7)



**1697**  
UF55 \*ISO-55 (9)

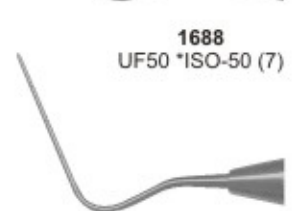

**1689**  
UF65 \*ISO-65



**1693**  
UF60 \*ISO-60



**1698**  
UF70 \*ISO-70

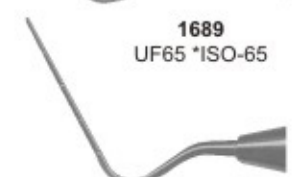

**1690**  
UF80 \*ISO-80



**1699**  
UF85 \*ISO-85



**1691**  
UF90 \*ISO-90



**1700**  
UF100 \*ISO-100



**1692**  
UF110 \*ISO-110



**1701**  
UF110 \*ISO-130





## Endodontic Condensers/Spreaders



1702  
UF120X



1703  
UF45N



1704  
UF60N



1705  
UF80N



1706  
UF100X



1707  
UE25 R-25



1708  
UE30 R-30



1709  
UE35 R-35



1710  
UE40 R-40



1711  
UE45 R-45



1712  
UE50 R-50



1713  
UF120X

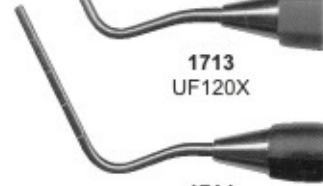

1714  
UF140X



1715  
TFD3545N



1716  
TFD6080N



1717  
UE55 R-55



1718  
UE60 R-60

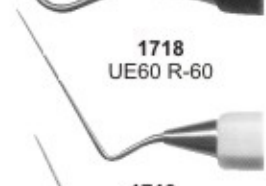

1719  
UE25N R-25



1720  
UE30N R-30



1721  
UE40N R-40



# Obturation Instruments



**1722**  
No. D11



D1 .33mm, D16 .95mm

**1723**  
No. D11T



D1 .24mm, D2 .84mm

**1724**  
No. KR1



D1 .23mm, D2 .61mm

**1725**  
No. 25S

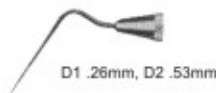

D1 .26mm, D2 .53mm

**1726**  
No. W1S



D1 .25mm, D16 .55mm

**1727**  
No. W2S



D1 .40mm, D2 .70mm



**1728**  
Lucks No.1



**1729**  
Lucks No.2



**1730**  
Lucks No.3



**1731**  
Lucks No.4

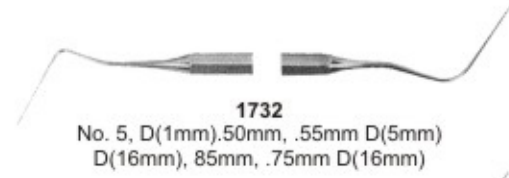

**1732**  
No. 5, D(1mm).50mm, .55mm D(5mm)  
D(16mm), 85mm, .75mm D(16mm)

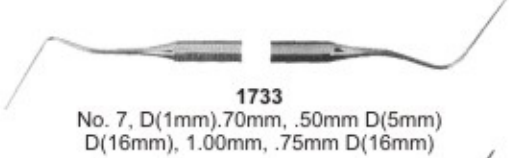

**1733**  
No. 7, D(1mm).70mm, .50mm D(5mm)  
D(16mm), 1.00mm, .75mm D(16mm)



**1734**  
No. 9, D(1mm)1.00mm, .63mm D(5mm)  
D(16mm), 1.30mm, .75mm D(16mm)

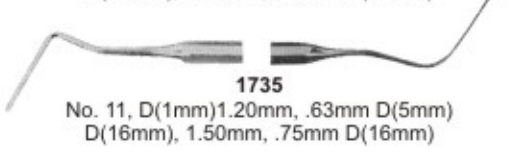

**1735**  
No. 11, D(1mm)1.20mm, .63mm D(5mm)  
D(16mm), 1.50mm, .75mm D(16mm)



**1736**  
No.1 (D1 .35mm, D16 .75mm)



**1737**  
No.2 D1 .55mm, D16 .85mm



**1738**  
No.3 D1 .85mm, D16 1.15mm



**1739**  
No.4 D1 1.00mm, D16 1.30mm

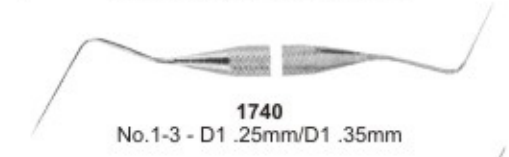

**1740**  
No.1-3 - D1 .25mm/D1 .35mm

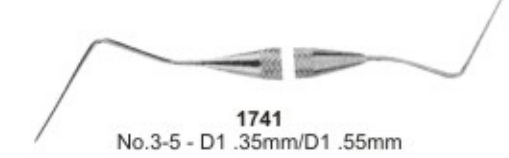

**1741**  
No.3-5 - D1 .35mm/D1 .55mm

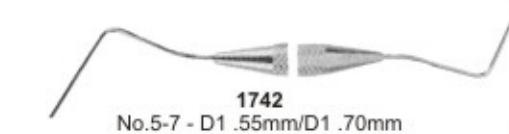

**1742**  
No.5-7 - D1 .55mm/D1 .70mm

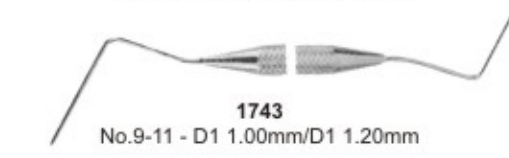

**1743**  
No.9-11 - D1 1.00mm/D1 1.20mm



## Excavators

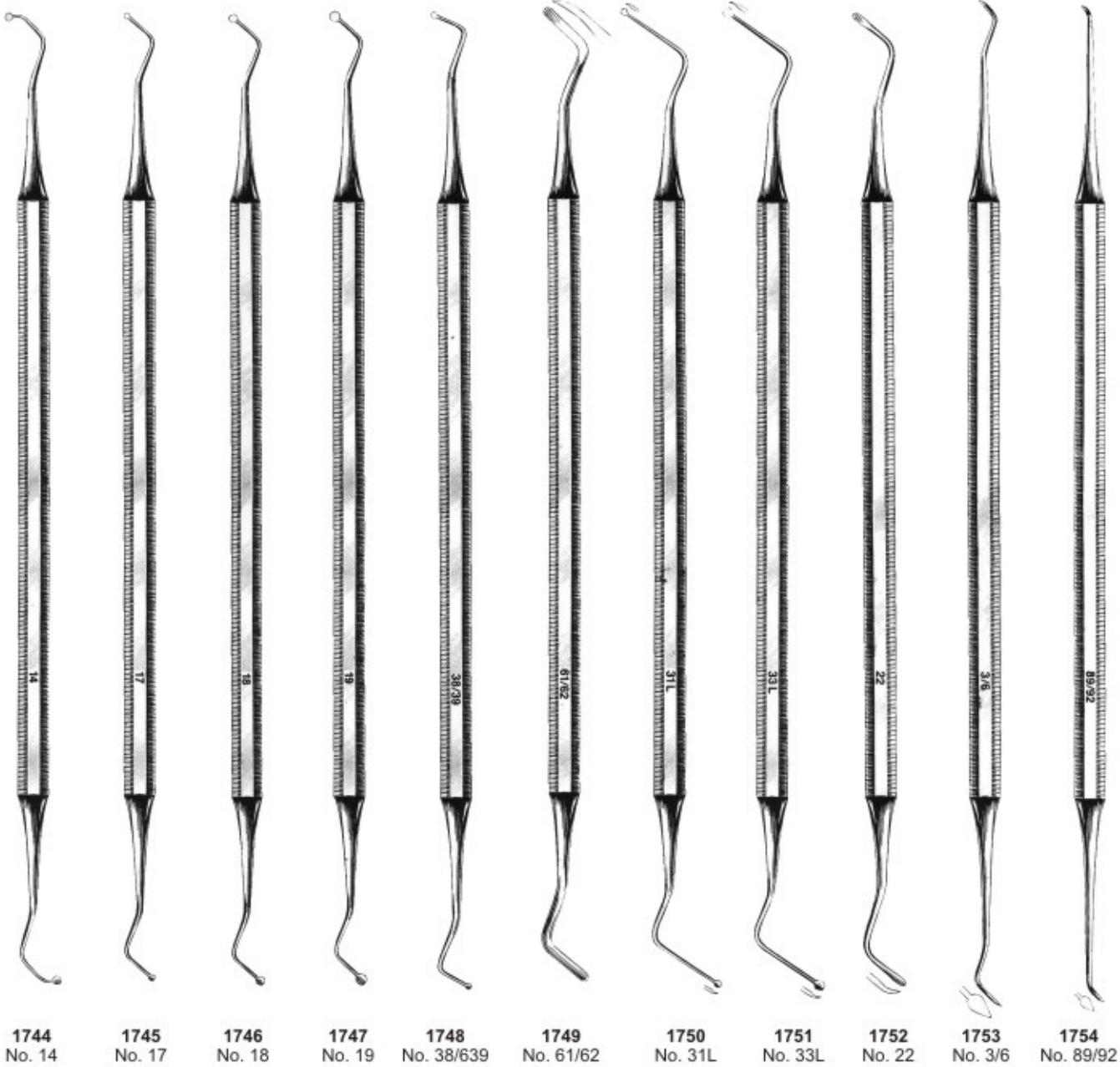

1744  
No. 14

1745  
No. 17

1746  
No. 18

1747  
No. 19

1748  
No. 38/39

1749  
No. 61/62

1750  
No. 31L

1751  
No. 33L

1752  
No. 22

1753  
No. 3/6

1754  
No. 89/92





## Excavators

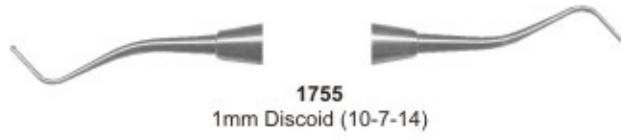

**1755**  
1mm Discoid (10-7-14)



**1756**  
1mm Discoid (38-39) (11.5-7-14)



**1757**  
E2 Discoid (15-9-15)



**1758**  
1.5mm Discoid (15-8-14)



**1759**  
E3 Discoid (25-9-15)



**1760**  
2mm Discoid (20-9-14)



**1761**  
1.5mm Spoon (15-8-14)



**1762**  
E1 Discoid (12-9-15)



**1763**  
2mm Spoon (20-9-14)



**1764**  
17 Tear-Drop



**1765**  
19 Tear-Drop



**1766**  
18 Tear-Drop



**1767**  
20 Tear-Drop





# Excavators, Explorer / Probes



## Excavators



1768  
31L



1769  
31W



1770  
33L



1771  
32L



## Explorers / Probes



1772  
G16D-L



1773  
Explorer No.2



1774  
Explorer No.16



1775  
16-23 Explorer



1776  
16-17 Explorer



1777  
DG16 Explorer



1778  
(Heavy DG-16)





# Explorers



1779  
1D

1780  
2D

1781  
3D

1782  
5D

1783  
6D

1784  
7D

1785  
3A-S

1786  
6S

1787  
7S

1788  
17S

1789  
23S





## Explorers

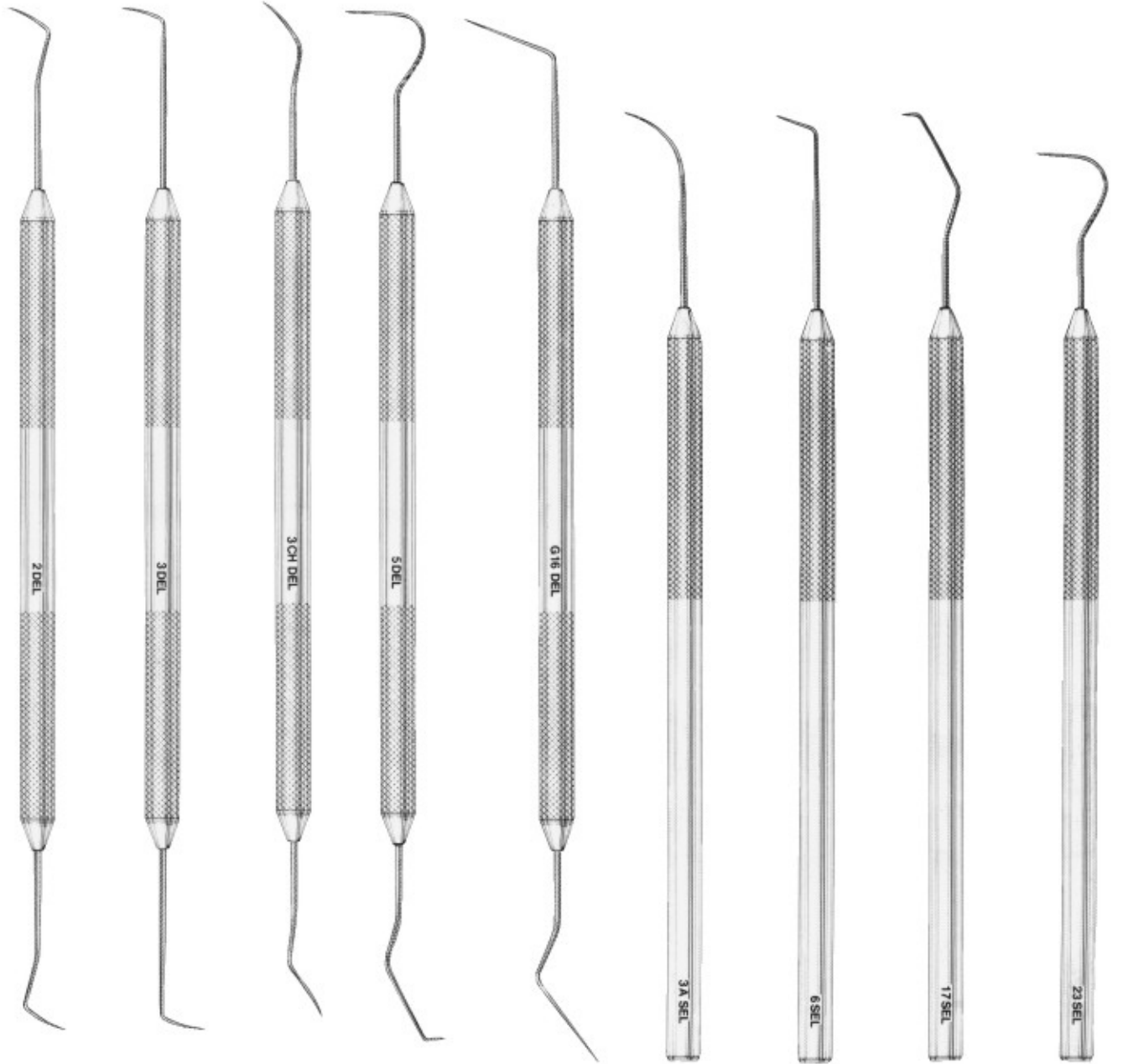

**1790**  
No. 2D-L

**1791**  
No. 3D-L

**1792**  
No. 3CHD-L

**1793**  
No. 5D-L

**1794**  
No. G16D-L

**1795**  
No. 3AS-L

**1796**  
No. 6S-L

**1797**  
No. 17S-L

**1798**  
No. 23S-L



# Explorer / Probe Combination

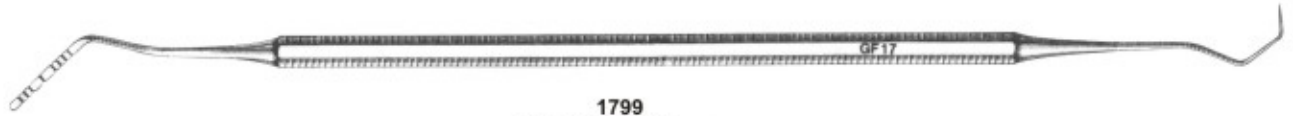

**1799**  
Gf17 Probe/Explorer

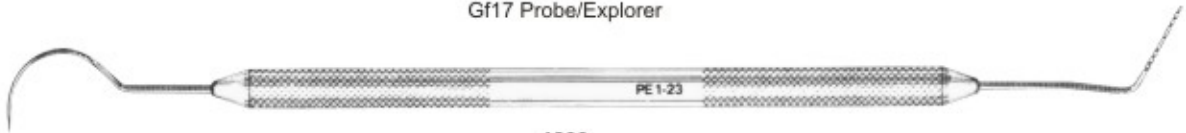

**1800**  
PE 1-23 Probe/Explorer

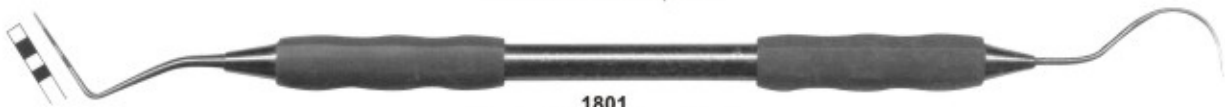

**1801**  
Probe 0 / 23 Explorer (fine)



**1802**  
Probe 1 / 23 Explorer



**1804**  
Probe 4 / 23 Explorer



**1803**  
Probe OW / 23 Explorer

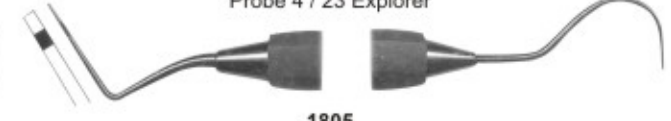

**1805**  
Ball Tip Probe WHO / 23 Explorer

## PROBES



**1806**  
Gf18 Probe



**1807**  
"C" Probe



**1808**  
X2 Probe



**1809**  
1-2 (Probe 2 end is flat)



**1810**  
1 UNC 15



**1811**  
4 SE



# Cord Packers, Hatchets, Hoes



## CORD PACKERS



1812

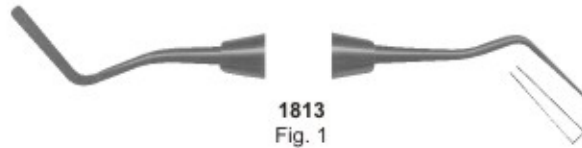

1813  
Fig. 1



1814  
Fig. 2



1815  
BLOOMFIELD  
Fig. 2 (off angle)



1816  
Fig. 1



1817  
CSI-1 (slightly serrated on ends)

## HATCHETS



1818  
1mm (10-7-14)



1819  
1.3mm (13-10-16)



1820  
1.5mm (15-8-14)

## HOES

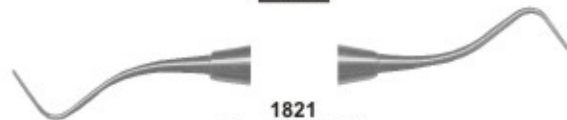

1821  
1mm (10-8-16)



1822  
UWH 18-19



1823  
UWH 16-18



1824  
UWH 20-21





## P.K.Thomas waxing & Gracey Currettes Set



**1825**  
P.K.Thomas 1



**1826**  
P.K.Thomas 2



**1827**  
P.K.Thomas 3



**1828**  
P.K.Thomas 4



**1829**  
P.K.Thomas 5

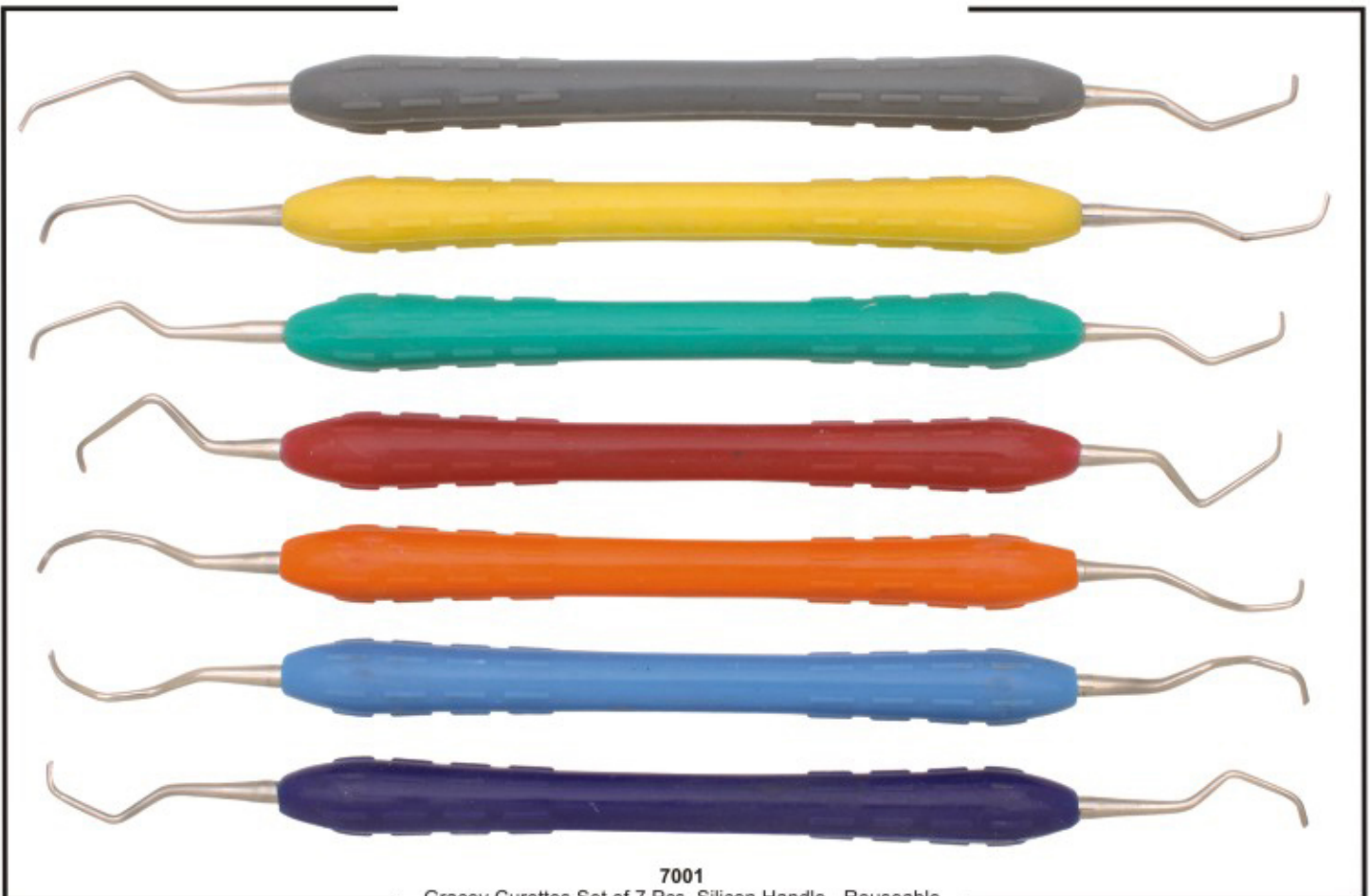

**7001**  
Gracey Currettes Set of 7 Pcs, Silicon Handle - Reuseable



# Amalgam Pluggers / Condensers / Applicators



**1830**  
BEHRMAN (Fig. 1)



**1831**  
BLACK (Fig. 1-2)



**1832**  
MORQUETTE (Fig. 0/1)



**1834**  
Hollenback No. 1 Plugger



**1835**  
Hollenback No. 2 Plugger



**1833**  
Black Action 11/12 Plugger



**1836**  
Hollenback No. 3 Plugger



**1837**  
Blacks 0-1 (1mm-1.5mm)



**1838**  
Blacks 1-2 (1.5mm-2.5mm)



**1839**  
Bodkin 1 (.7mm-1mm)



**1843**  
.7mm-1mm



**1844**  
1mm-1.5mm



**1840**  
Bodkin 2 (1.5mm-2mm)



**1841**  
2.5mm-3mm



**1845**  
1.5mm-2mm



**1846**  
Oregon (Fig. 3)



**1842**  
Oregon 2



**1847**  
Oregon (Fig. 4)



**1848**  
UP 12



**1849**  
Applicator 1-2



**1850**  
Birtles Applicator Spatula



**1851**  
Birtles Applicator Spatula K



# Placement Instruments, Stopping Stoppers, Plugg

## Placement Instruments



**1852**  
PICH (Calcium Hydroxide Placer)



**1853**  
CA

## Stopping Stoppers



**1854**  
Woodson 2

Ø 1.6 mm

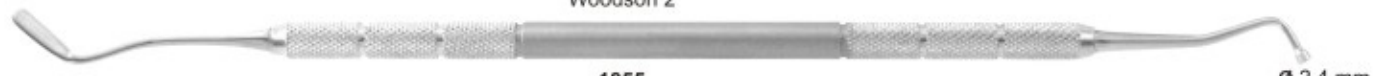

**1855**  
Woodson 3S

Ø 2.4 mm

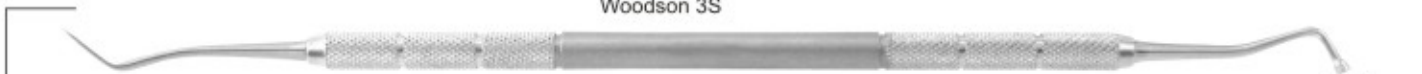

**1856**  
Woodson 3A

Ø 2.6 mm



**1857**  
Woodson 3

Ø 3.0 mm

## Pluggers



Ø 0.75 mm

**1858**  
Pluggers 0-1

Ø 1.2 mm

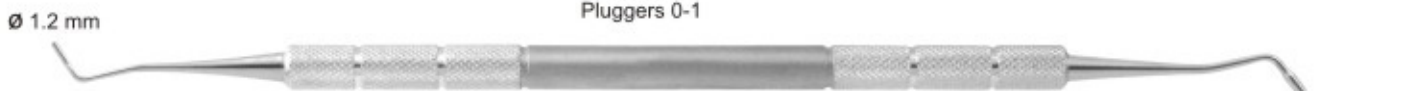

Ø 1.2 mm

**1859**  
Pluggers 1-4

Ø 1.6 mm

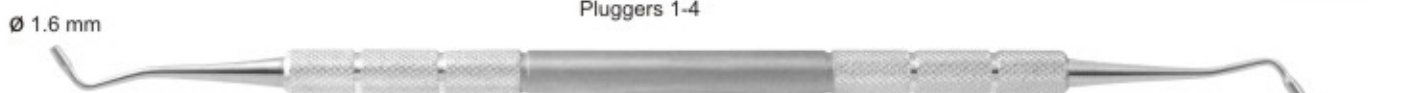

Ø 1.6 mm

**1860**  
Pluggers 4-6

Ø 2.0 mm

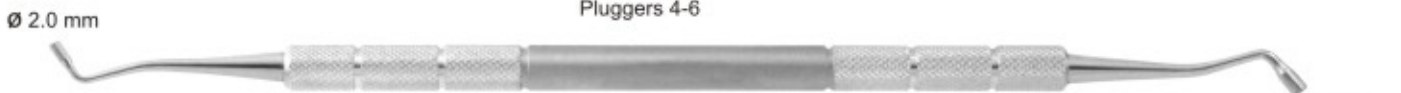

Ø 2.0 mm

**1861**  
Pluggers 6-8

Ø 2.5 mm

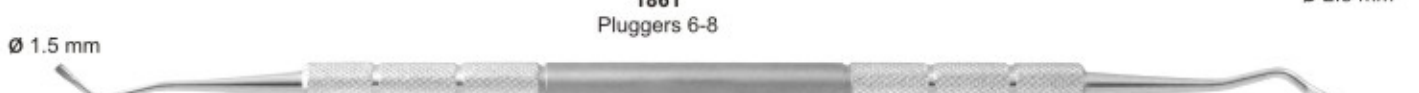

Ø 1.5 mm

**1862**  
Black 1-2

Ø 2.6 mm



Ø 3.6 mm

**1863**  
Black 2-3

Ø 5.0 mm





# Burnishers



1864  
Fig. 1



1865  
Fig. 28/29



1866  
Fig. 34



1867  
Fig. 27/29



1868  
Fig. 21B



1869  
ACORN  
Fig. 21



## TABLE OF CONTENTS

<b>01</b>	Tooth Extracting Forceps		<b>01-49</b>
<b>02</b>	Root Elevators		<b>50-70</b>
<b>03</b>	Scalpel Handles, Handles, Mouth Mirrors Scalers, Explorer / Probes		<b>71-85</b>
<b>04</b>	Endodontic Condensers, Obturation Instruments Excavators, Explorer / Probes, Curette Sets		<b>86-96</b>
<b>05</b>	Amalgam Pluggers / Condensers, Burnishers		<b>97-100</b>
<b>06</b>	Wax Carvers, Carvers, Chisels		<b>101-103</b>
<b>07</b>	Compote Placement, Plastic Filling Instruments		<b>104-107</b>
<b>08</b>	Curettes, Gracey Curettes, Dental Products, Knives		<b>108-117</b>



## TABLE OF CONTENTS

<b>09</b>	Wax Porcelain & Cement Instruments Wax & Modeling Instruments		<b>118-121</b>
<b>10</b>	Spatulas, Cement Spatulas		<b>122-124</b>
<b>11</b>	Files, Hoes, Knives, Wax & Plaster Knives, Crane Kaplan		<b>125-128</b>
<b>12</b>	Bone Curettes, Bone Files, Bone Chisels, Bone Mallets		<b>129-133</b>
<b>13</b>	Crown Removers, Crown Instruments		<b>134-136</b>
<b>14</b>	Implants & Measuring Instruments, Suction Tubes, Bone Gauges		<b>137-144</b>
<b>15</b>	Amalgam Guns & Carriers, Retainers, Bands, Strip Holders, Napkin Holders		<b>145-146</b>
<b>16</b>	Rubber Dam Instruments, Rubber Dam Clamps		<b>147-148</b>





## TABLE OF CONTENTS

<b>17</b>	Syringes, Tweezers, Sterilizing & Lab Instruments		<b>149-156</b>
<b>18</b>	Endodontic Forceps, Tissue Forceps, Haemostatic Forceps, Towel Clamps		<b>157-159</b>
<b>19</b>	Retractors, Lip & Cheek Retractors, Hooks, Depressors & Mouth Gags, Sterilizing Forceps		<b>160-164</b>
<b>20</b>	Orthodontic Pliers & Cutters, Rongeurs		<b>165-179</b>
<b>21</b>	Needle Holders, Scissors, Micro Surgery Set		<b>180-186</b>
<b>22</b>	Impression Trays		<b>187-193</b>
<b>23</b>	Articulators, Hollow Wares		<b>194-200</b>
<b>24</b>	Scissors, Dissecting Forceps, Needle Holders, Wire Cutting Pliers With Tungsten Carbide Inserts		<b>201-213</b>



## Alphabetical Index



### A

Adams, Pliers	174
Aderer, Pliers	174
Adson, Forceps	158,207
Adson, Tweezers	151
Ainsworth, Rubber Dam Punch	147
Albee	143
Albrecht, Tweezers	155
Allen, Tweezers	155
Allis, Tissue Forceps	158
Amalgam Applicators	97
Amalgam Condensers	97
Amalgam Pluggers	97
Amalgam Carriers	145
Amalgam Guns	145
Andresen, Pliers	175
Andrews, Tongue Depressor	160
Angle, Pliers	169,174
Apical, Elevator	57,63
Arruga, T.C. Needle Holder	208,209
Articulators	194-195
Aspirating Syringes	149
Allen 9A, Elevator	50

### B

Baby-Allis, Tissue Forceps	158
Band Removing Pliers	170
Bane, Rongeurs	179
Barnhart, Curettes	110,116
Barry, Elevator	66,69
Baum Gartner, Needle Holder	180,211
Bee Be, Scissors	186
Bein, Elevator	54,61
Beyer, Rongeurs	179
Bird Beak Pliers	167
Blumenthan, Rongeurs	176
Boley Gauge	143
Bone Curettes	129
Boynton, Needle Holder	181
Bozemann-Wertheim, T.C. Needle Holder	210
Bracket, Pliers	170
Brewer, Rubber Dam Instruments	147
Brown, Tissue Forceps	158
Brown-Adson, Tissue Forceps	158
Bruns, T.C. Scissors	203
Buchs, Retractor	162
Burnishers	99-100
Ball Chain	146
Boley Gauge,	143

Bone Gauge,	144
Bone Mill Forcep,	139
Bone Pluggers,	140
Bracket, Gauge	144
Buser, Elevator	52

### C

Carvers	102,103
Castroviejo, Needle Holder	181,208,209
Castroviejo, scissors	186
Castroviejo, Gauge	144
Castroviejo, Sclerer Marker	144
Cement Instruments	118,119,121
Cement Spatulas	120,122
Chisels	103
Chompret, Elevator	63
Cleveland, Rongeurs	177,178
College, Tweezers	152,154
Collier, Needle Holder	180
Collin, Retractor	162
Columbia, Curettes	110,111,116
Composite Placement	104,105
Con Scodellino, Wax Knives	126
Cord Packers	95
Cottle, Scissors	184
Coupland, Elevator	58
Crane-Kaplan	128
Crile, Forceps	157
Crile, Needle Holder	181
Crile-Wood, Needle Holder	180
Crown Instruments	135,136
Crown Removers	134,135
Crown Shell, Pliers	166
Cryer, Elevator	55,58,69
Cushing , T.C. Forceps	207
Cushing, Tweezers	151
Cushing-Taylor , T.C. Forceps	207

### D

De Bakey , T.C. Forceps	207
De Bakey, Scissors	184,186,206
De Bakey, T.C. Needle Holder	209
De La Rosa, Pliers	169
Deaver, Scissors	184
Denhart, Mouth Gag	160
Derf, Needle Holder	180
Disposable Products	117
Dr.Sader, Elevator	69
Dressing Forceps	207
Dean Scissors	186,205





# Alphabetical Index



## E

Elevators	51
Endodontic Condensers	86,87
Ernert, Wax Knives	126
Excavators	89-91
Explorers	80-82,91-94
Extracting forceps (American Pattern)	36-49
Extracting forceps (English Pattern)	1-24
Extracting forceps (fitting handle)	25-33
Extracting forceps (For Children)	34

## F

Fahnenstock, Wax Knives	126
Files	125
Filling Instruments	106,107
Fine, T.C. Scissors	206
Finocchio, T.C. Needle Holder	211
Finocchio, T.C. Needle Holder	211
Fischer, Pliers	175
Flagg, Tweezers	154
Flohr, Elevator	56
Fomon, Tissue Retractor	164
Freer, Elevator	52
Friedman, Rongeurs	178
Furrer, Pliers	174
Film Hanger	146
Finger Cup	197
Flohr, Elevator	57
Freer	15,16,
Elevator	52

## G

Gardner, Bone Chisels	132
Gardner, Needle Holder	180
Gardner, Rongeurs	178
Gillies, Hook	164
Gillies, Tweezers	151
Goldman Fox , T.C. Scissors	206
Goldman Fox, Curettes	112,113
Goldman Fox 14, Elevator	50
Goldman Fox, knives	114
Goslee, Pliers	175
Gracey Curettes	108,109,116

## H

Halsey, T.C. Needle Holder	209
Handles	72
Hartman, Rongeurs	179

Hatchets	95
Heaney, T.C. Needle Holder	211
Hegar, T.C. Needle Holder	209
Hegar-Vascular, T.C. Needle Holder	209
Heidbrink, Elevator	64,67,69
Heidbrink, Elevator	57
Howard 9H, Elevator	52
Height Gauge,	143
Hepp-Scheidle, T.C. Needle Holder	208
Hlasted-Mosquito, Forceps	159
Hoes	95,125
Hollow Wares	196-200
How, Pliers	167,174
Howard, Bone Files	131
Hylin, Elevator	61

## I

Implants Instruments	
Impression Trays	137-141
Iris Scissors	187-193
Ivory, Rubber Dam Instruments	183
	147

## J

Jarabak, Pliers	165
Joseph, Scissors	183
Johnson, Pliers	169,175
Joseph, Tissue Retractor	164

## K

Kalt, T.C. Needle Holder	208
Kelly, Forceps	159
Kelly, Scissors	183
Kelly Scissors	205
Kim's Plier	165
Kirkland, knife	114
Knives	125
Knowles, Scissors	184
Kocher, Retractor	162
Kocher-Langenbeck, Retractor	162
Kopp, Elevator	60,68
Kopp , Tweezers	151

## L

Lab & Office Pliers	166
Landgraf, Tweezers	154
Langenbeck, Pliers	175
Langenbeck, Retractor	162





## Alphabetical Index



Langenbeck, T.C. Needle Holder	212
Langer, Curettes	110,116
Langhals, T.C. Needle Holder	212
Lecluse, Elevator	65
Lessmann, Wax Knives	126
Lexer, T.C. Scissors	202
Lichtenberg, T.C. Needle Holder	212
Ligature , T.C. Scissors	207
Lip & Cheek Retractors	161,162
Lister, Scissors	184
Littauer, Scissors	186
Littler, Scissors	184
Locklin, Scissors	186
London Hospital, Elevator	62
London-College, Tweezers	154,155
Lucae, T.C. Forceps	
Luehty-Beck, T.C. Needle Holder	212
Lwanson, Crown Gauge	143
Lagrange, Scissors	186,205
Littaure, Scissors	186
Lwanson, Crown Gauge	143

### M

Martin, T.C. Needle Holder	210
Mathieu, Needle Holder	181,211
Mathieu-Kosher, T.C. Needle Holder	211
Mathieu-Ryder, T.C. Needle Holder	212
Mathieu-Vascular, T.C. Needle Holder	211
Mayo Harrington, T.C. Scissors	205
Mayo, Scissors	185,204
Mayo-Hegar, Needle Holder	181
Mayo-Hegar, T.C. Needle Holder	209
Mayo-Lexer, T.C. Scissors	202
Mayo-Stille, T.C. Scissors	202
Mayo-Stille Scissors	185
Mc Kellops, Pliers	175
Mccalls, Curettes	110,111,116
Mcindoe, Tweezers	151
Mead, Bone Mallets	133
Mead, Elevator	64
Mead, Rongeurs	179
Meriam , T.C. Forceps	207
Meriam, Tweezers	153,155
Metzenbaum Fino, T.C. Scissors	203,204
Metzenbaum, Scissors	185,203
Micro Surgery Set	182
Micro-Adson, Tweezers	151
Micro-Friedman, Rongeurs	178
Middledorpf Retractor	162
Miller, Articulating Forceps	147
Miller, Bone Files	130

Mini-Blumenthan, Rongeurs	176
Molt, Elevator	50
Molt, Mouth Gag	160
Molt 9, Elevator	50
Morrison, Elevator	56
Mouth Mirrors with Handles	73
MSY, Pliers	175
Mullar Claus, Wire Cutting Pliers T.C.	213

### N

Nance, Pliers	168,169,174
Napkin Holders	146
Neivert, Needle Holder	180
Nelson-Metzenbaum, Scissors	185
Non Chill	146

### O

O'Brien, Pliers	168
Obturation Instruments	88
Ochsenbein	128
Ordan, knife	114
Oehler, T.C. Forceps	208
Olsen-Hegar, Needle Holder	180
Optical Pliers	168
Orthodontic Cutters, T.C.	172
Orthodontic Distal & Cutters	173
Orthodontic Pliers, T.C.	171
Ott, Elevator	62

### P

Parametrium, T.C. Scissors	205
Partsch, Bone Chisels	133
Partsch, Bone Mallet	133
Pean, Forceps	157
Peeso, Pliers	166,175
Peets, Forceps	157
Perry, Tweezers	151
P.K. Thomas,	96
Pich,	98
Pluggers,	98
Prichard, Elevator	50
Plastic Handle Elevators	70
Polokoff, Bone File	131
Pott, Elevator	51
Potts-Smith, T.C. Forceps	208
Potts-Smith, T.C. Needle Holder	208
Probes	82-85,91,94

### Q

Quinby, Scissors	183
------------------	-----



# Alphabetical Index



## R

Ragnell , T.C. Scissors	206
Retainers, Bands	146
Reynolds, Pliers	169,174
Root Planning Curettes	115
Root splinter forceps	35
Roux, Retractor	162
Rubber Dam Clamps	148
Rubber Dam Holder	147
Rule, Curette	110
Russian, Tissue Forceps	158
Ryder, T.C. Needle Holder	210
Ryder-Vascular, T.C. Needle Holder	210

## S

Sarot, T.C. Needle Holder	210
Scalers	75-79
Scalpel Handles	71
Schwarz, Pliers	168,175
Schluger, File	114
Seldin, Elevator	50,55,67
Select, Tweezers	151
Semken, T.C. Forceps	207
Semkin, Tissue Forceps	158
Senn, Tissue Retractor	164
Separating Pliers	166
Sims, T.C. Scissors	205
Spatulas	123
Spencer, Scissors	186
Spencer-Wells, Forceps	157
Spreaders	87
Split Chisels,	128
Spring Bow Divider	143
Standard, T.C. Scissors	201
Standard, Tweezers	151
Steiner, Pliers	166
Sterilizing & Lab Instruments	156
Sterilizing Forceps,	163
Stevens, Needle Holder	181
Stevens, Scissors	183
Stille, Scissors	185
Stratte, T.C. Needle Holder	210
Strip Holder Clips	146
Syringes	150
Suction Tubes,	140,142
Sugarman, File	114

## T

Toennis, Wire Cutting Pliers T.C.	213
-----------------------------------	-----

Toennis-Adson, Scissors	184
Toennis, Tissue Retractor	164
Towel Clamps, Napkin Holders	159
Tweed, Pliers	168
Telescope, Crown Plier	136
Traymann, Crown Remover	128

## U

Universal , T.C. Scissors	207
Universal, Pliers	174
Universal, Elevator	135
Utility Plier	165

## V

Vernier, Measuring Instruments	143
Vernier Gauge	143

## W

Wakefield, Bone Chisels	132
Waldron, Pliers	174
Waldsachs, Pliers	174
Wangensteen, T.C. Forceps	208
Warwick-James, Elevator	62
Waugh, Tweezers	151
Wax & Modeling Carvers	120
Wax & Plaster Knives	127
Wax Carvers	101
Wax, Porcelain Instruments	118,119,121
Webster, Needle Holder	180,209
Weingart , Utility Pliers	167
Weitlaner, Retractor	160
West, Elevator	50
White, Rubber Dam Instrument	147
Wieder, Tongue Depressor	160
Winter, Elevator	65,69
Wire & Clasp Bending Pliers	170
Wire Bending Pliers	166
West, Elevator	50
Wire Cutter	165
Woodson,	98

## Y

Young, Pliers	168,174
---------------	---------

## Z

Zuricher, Measuring Instrument	143
Zuricher, Gauge	143



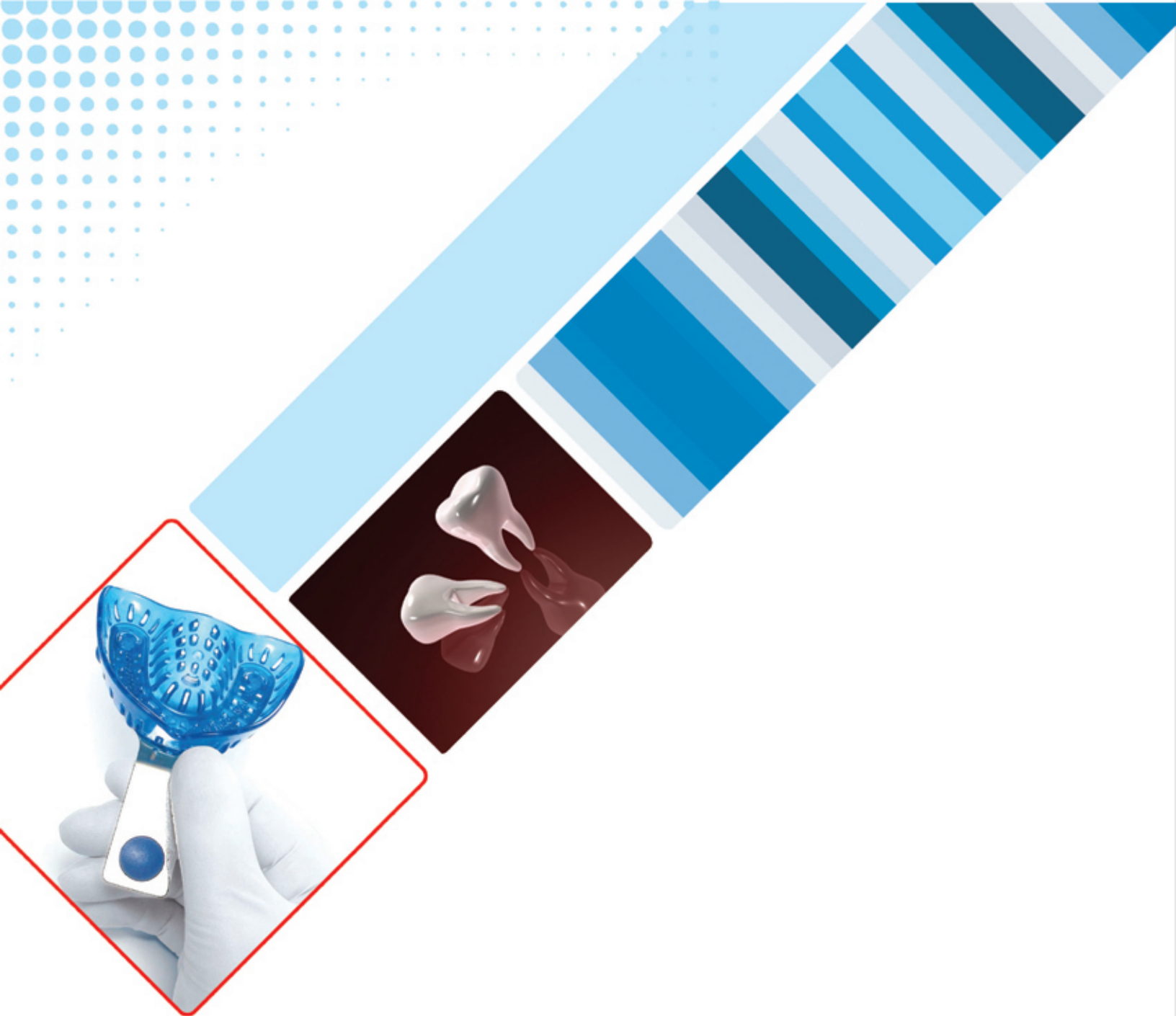

**Address:**

**Dynamic Products  
Kashmir Road  
Sialkot 51310, Pakistan.**

**Cell: +92 317 7368341**

**Whats app: +92 317 7368341**

**Email: [info@dynamicproducts.com.pk](mailto:info@dynamicproducts.com.pk)**

**Gmail: [dynamicproducts@gmail.com](mailto:dynamicproducts@gmail.com)**